





6



F



F1





**F2**



**F3**



**F4**

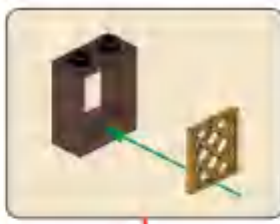

**F5**





**F6**



**F7**



**F8**



**F9**





**F10**



**F11**

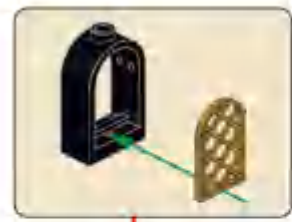

**F12**

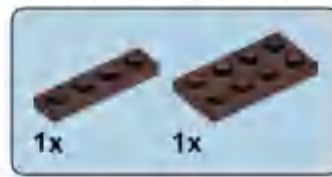

**F13**





**F14**



**F15**



**F16**



**F17**

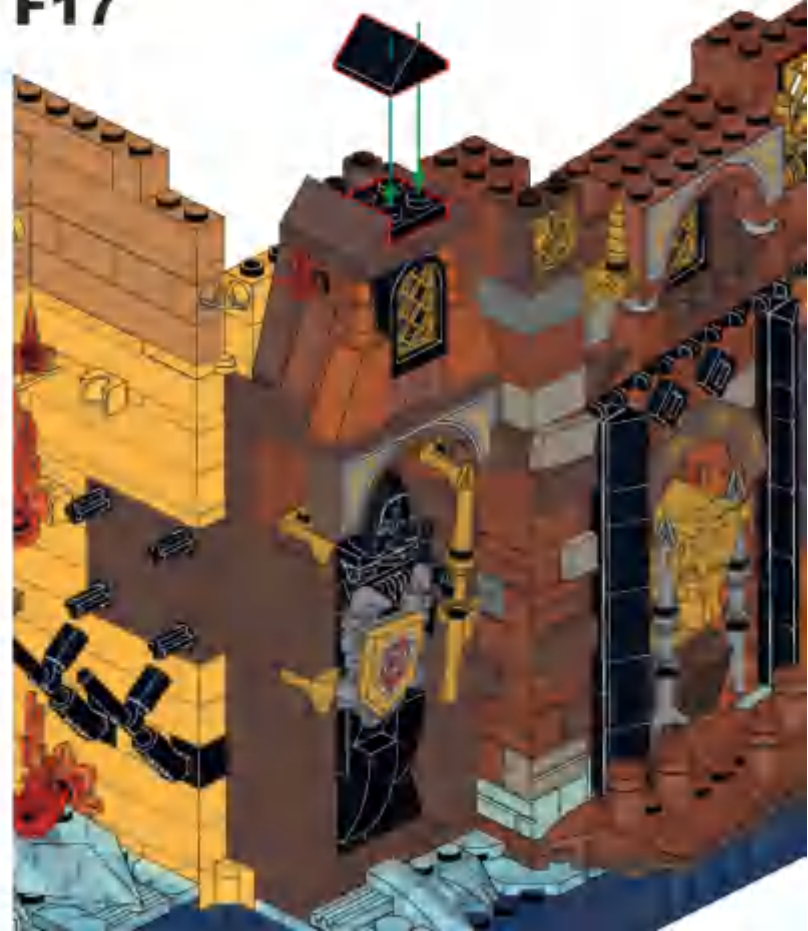



**F18**



**F19**



**F20**



**F21**

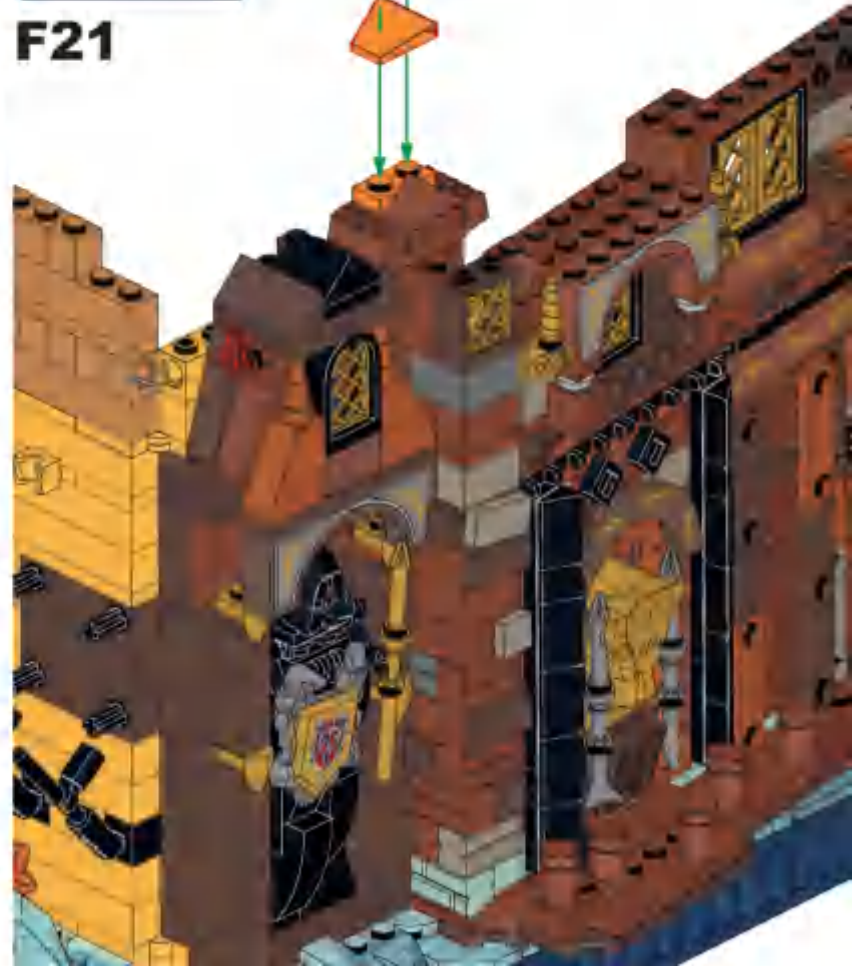



**F22**



**F23**



**F24**











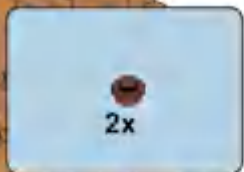

F40

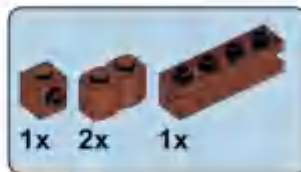

F41

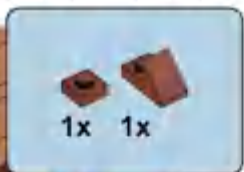
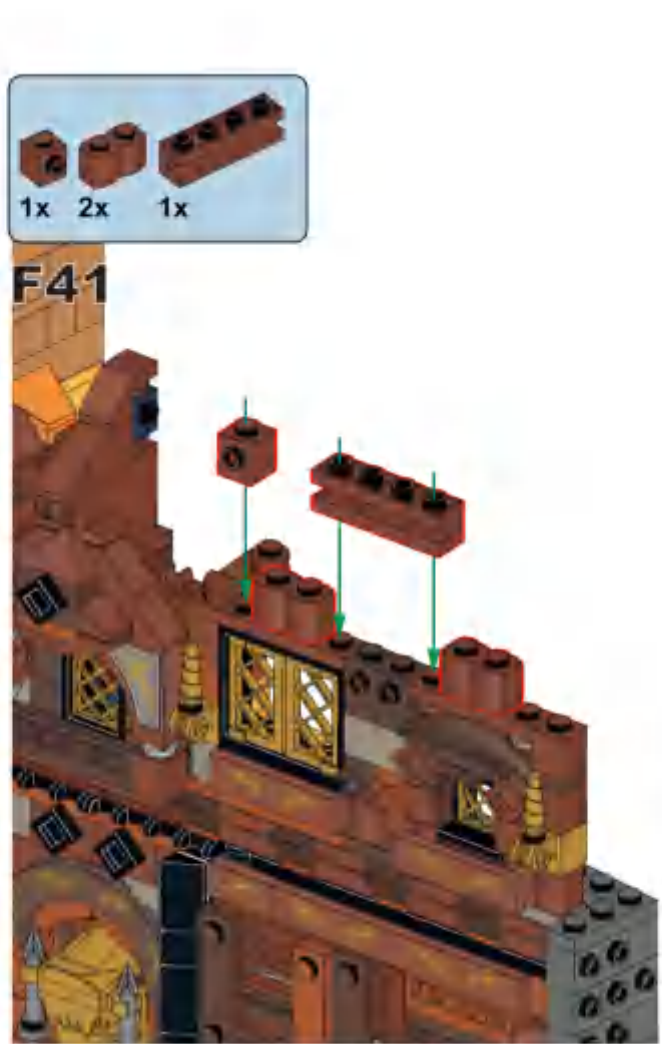

F42



F43



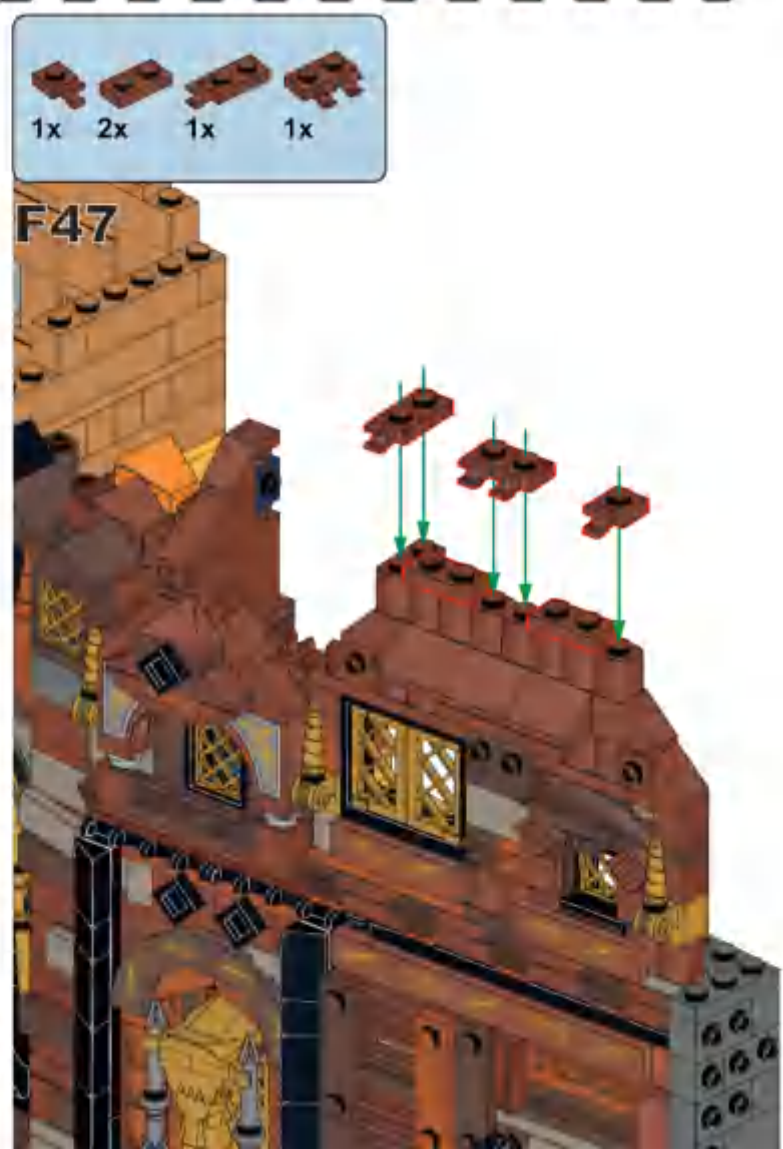
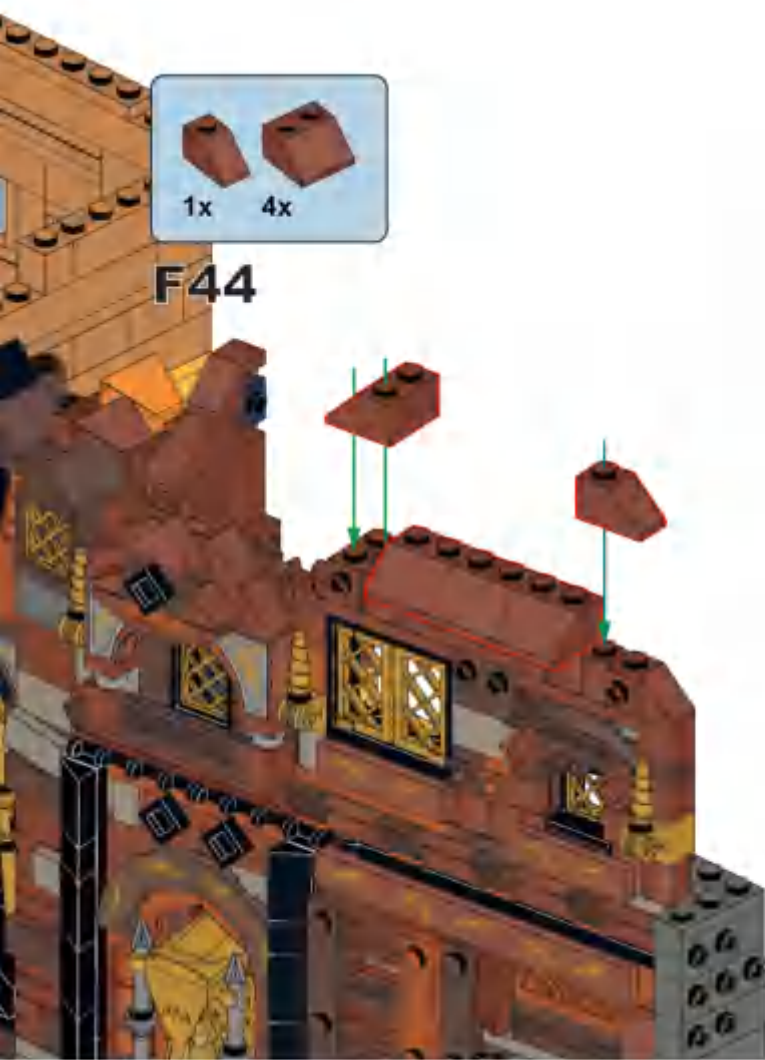



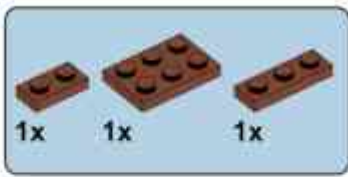

**F51**

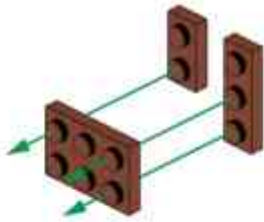

**F52**

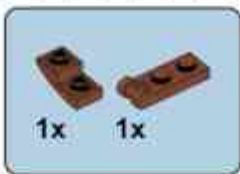
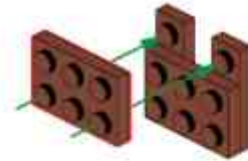

**F53**



**F54**

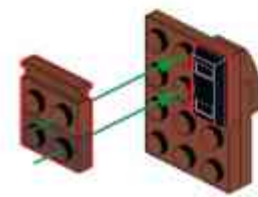

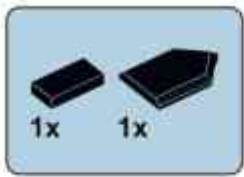

**F55**

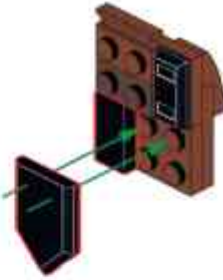

**F56**

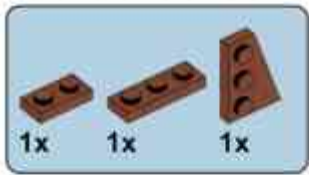
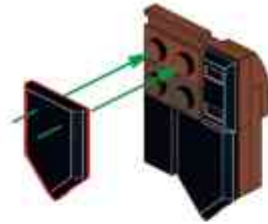

**F57**

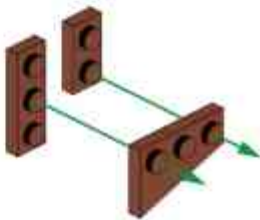

**F58**

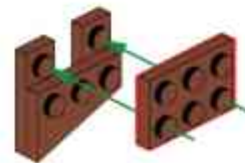

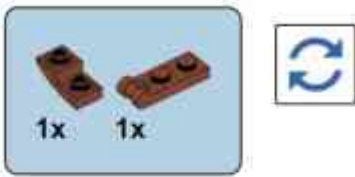

**F59**

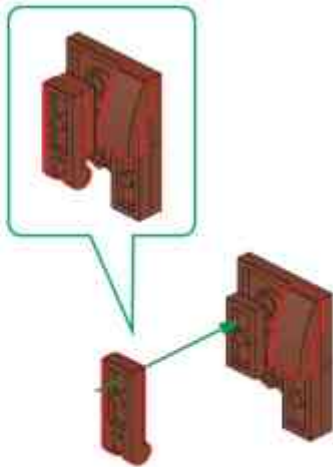

**F60**

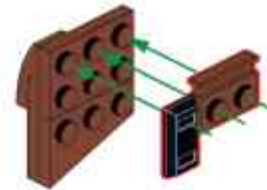

**F61**

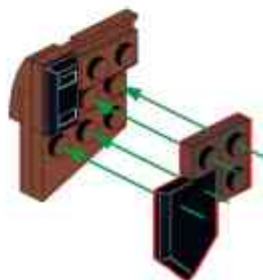

**F62**

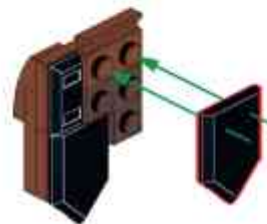

**F63**

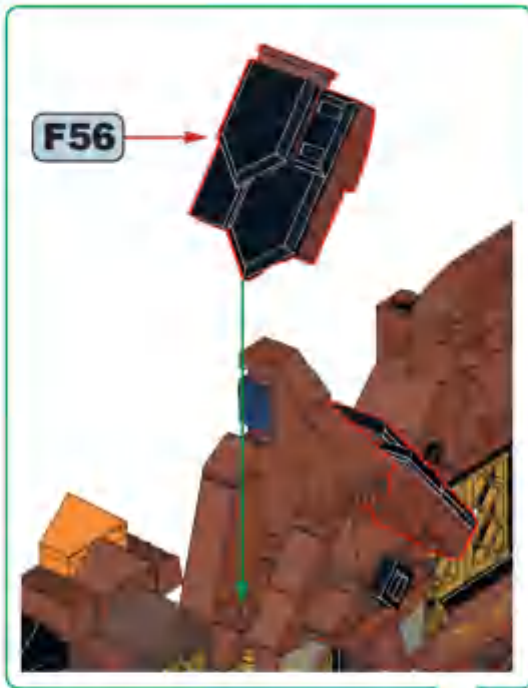



2x 2x

F64



x2

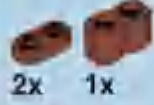

2x 1x

F65

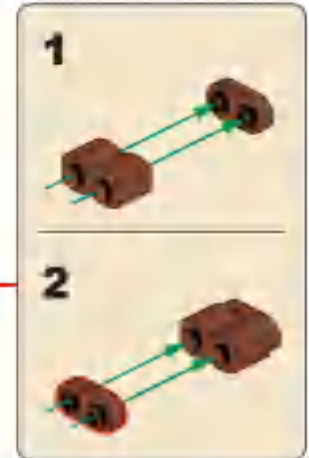

1

2

2x

F66



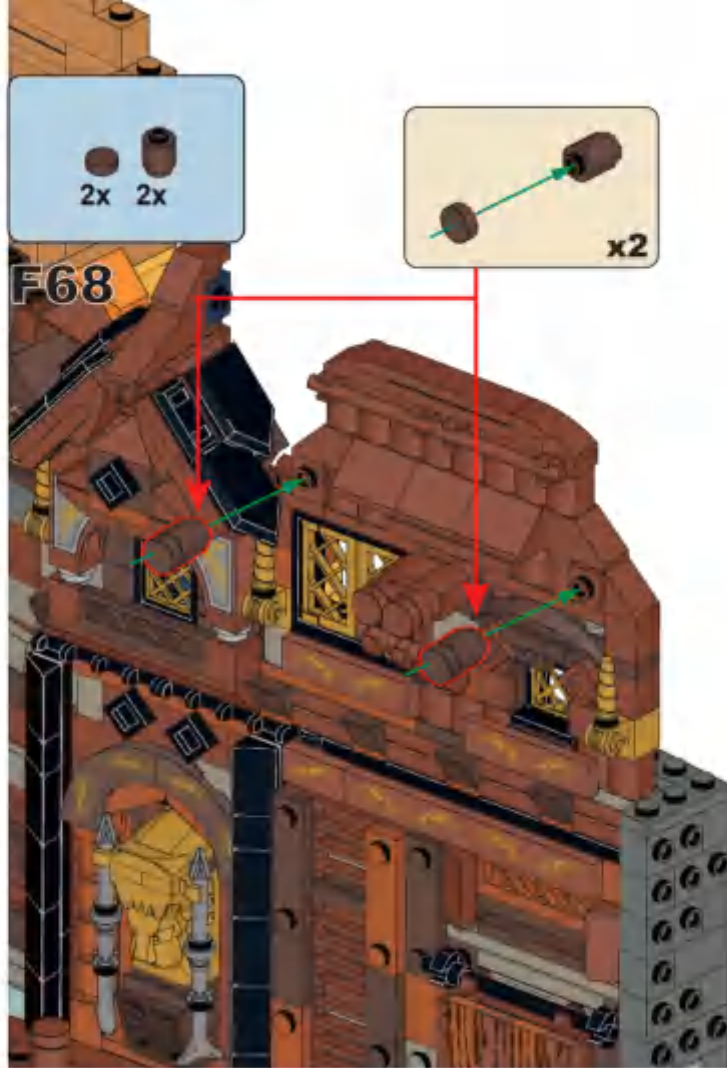

**F69**



**x4**



**F70**



**x4**



**F71**



**x4**



**F72**



**x4**

**F73**

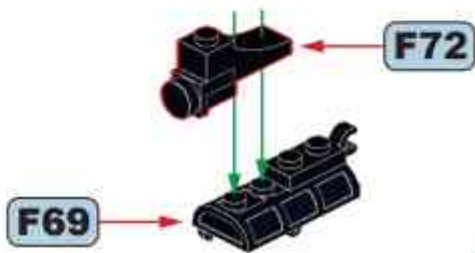

**x4**



**F74**

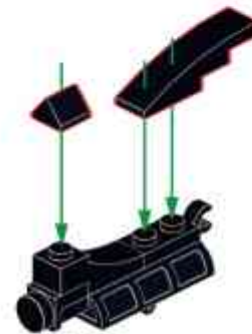

**x4**

**F75**

**F68**

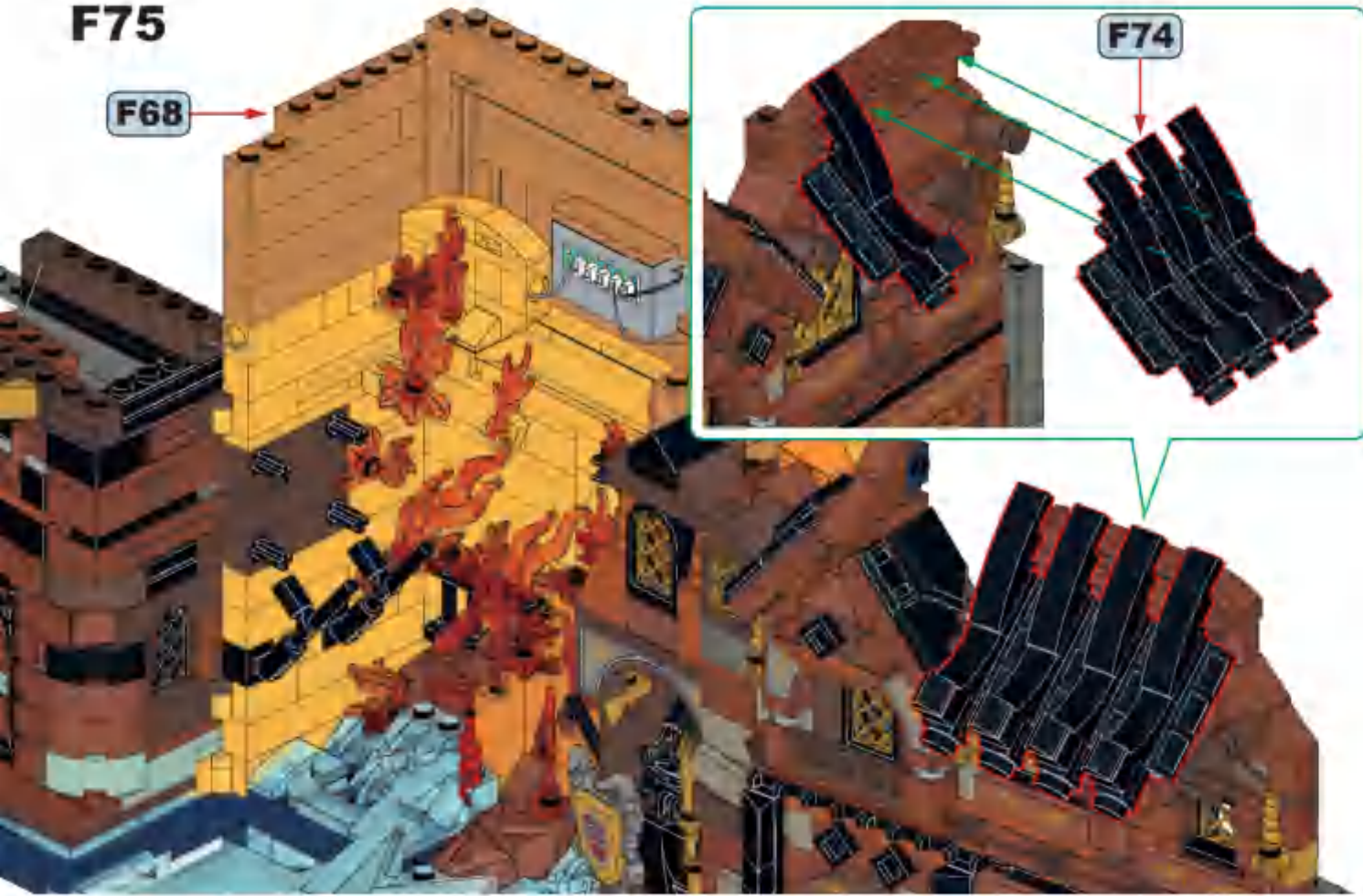
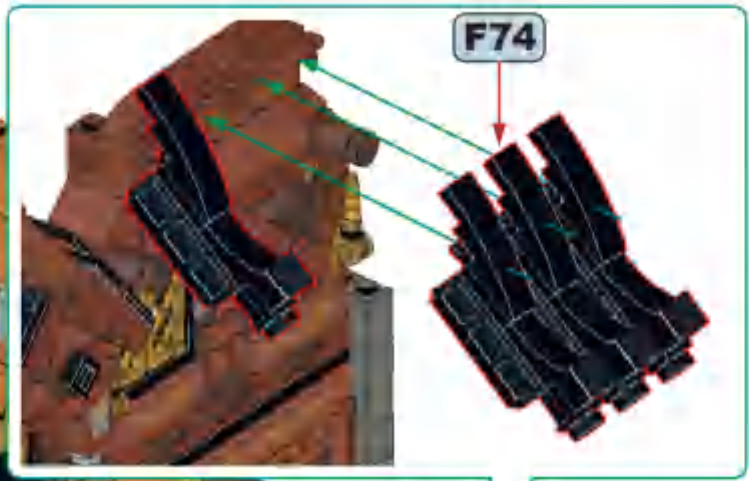

**F76**

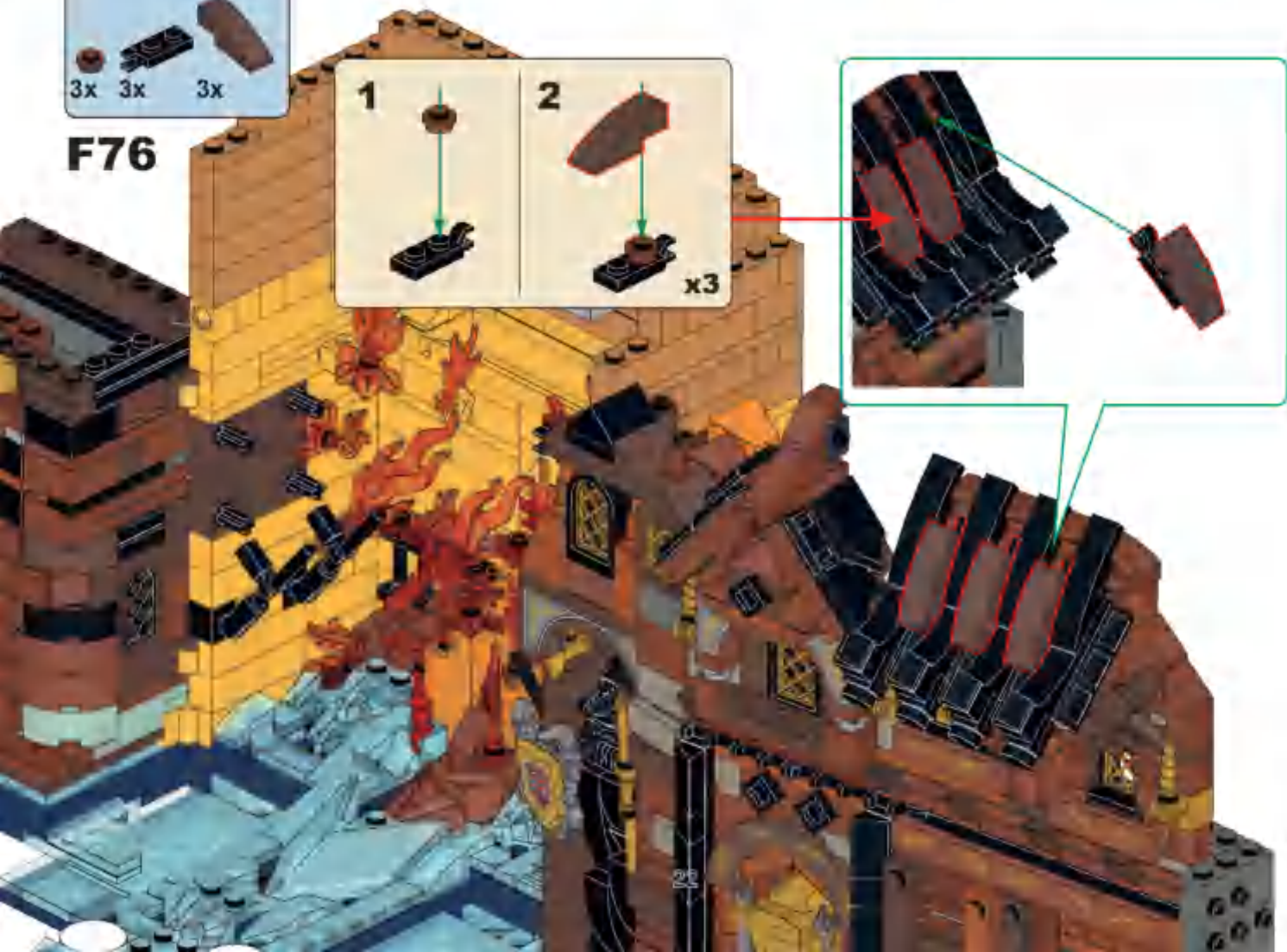
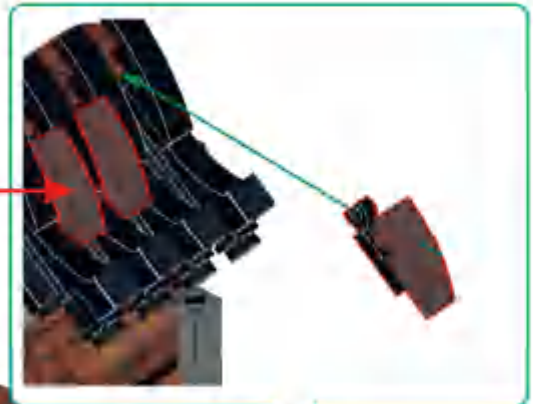



F77

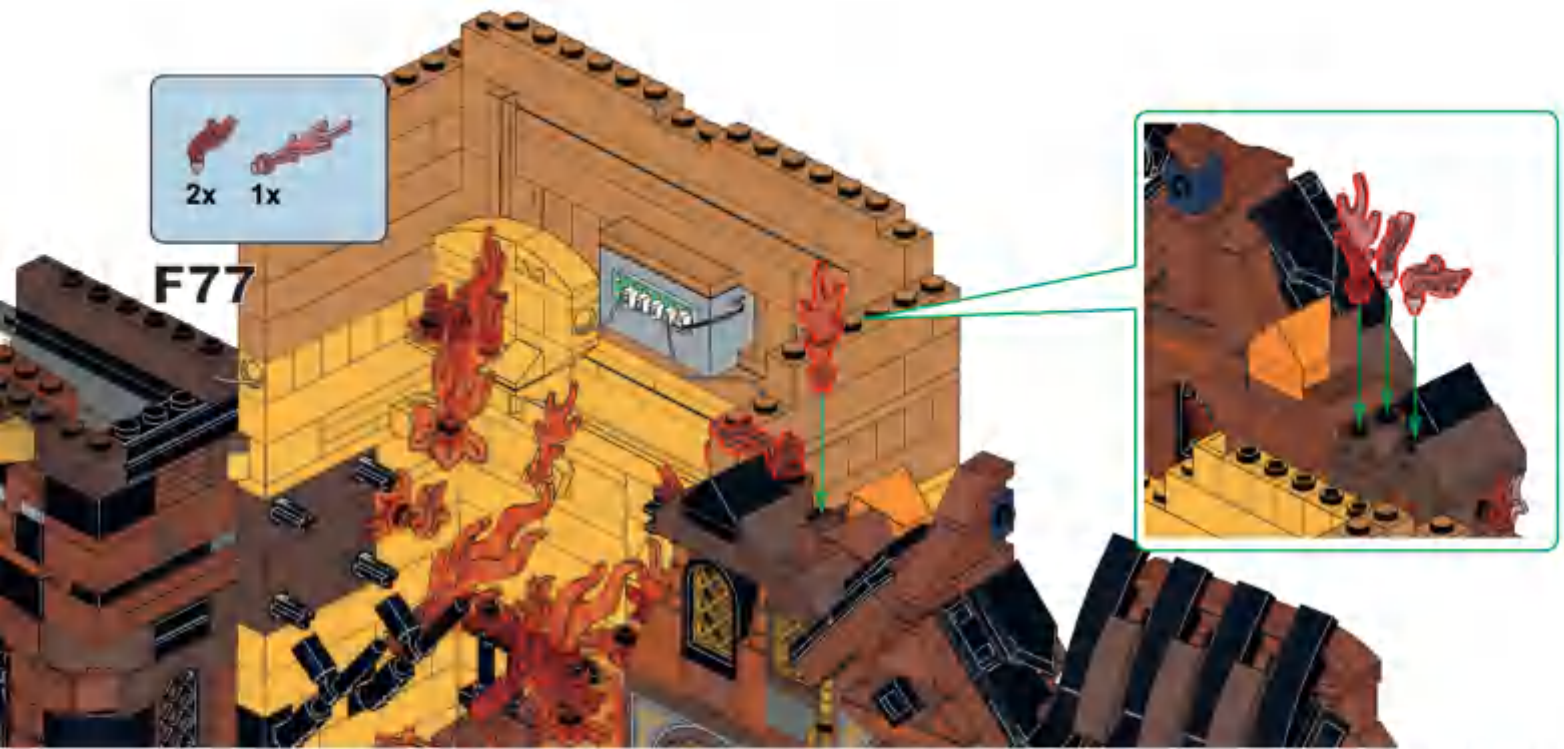

F78

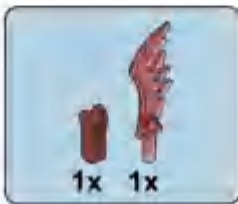
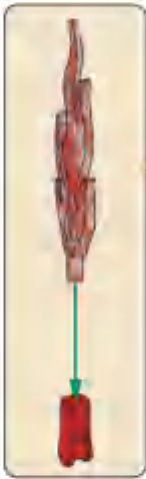

F79

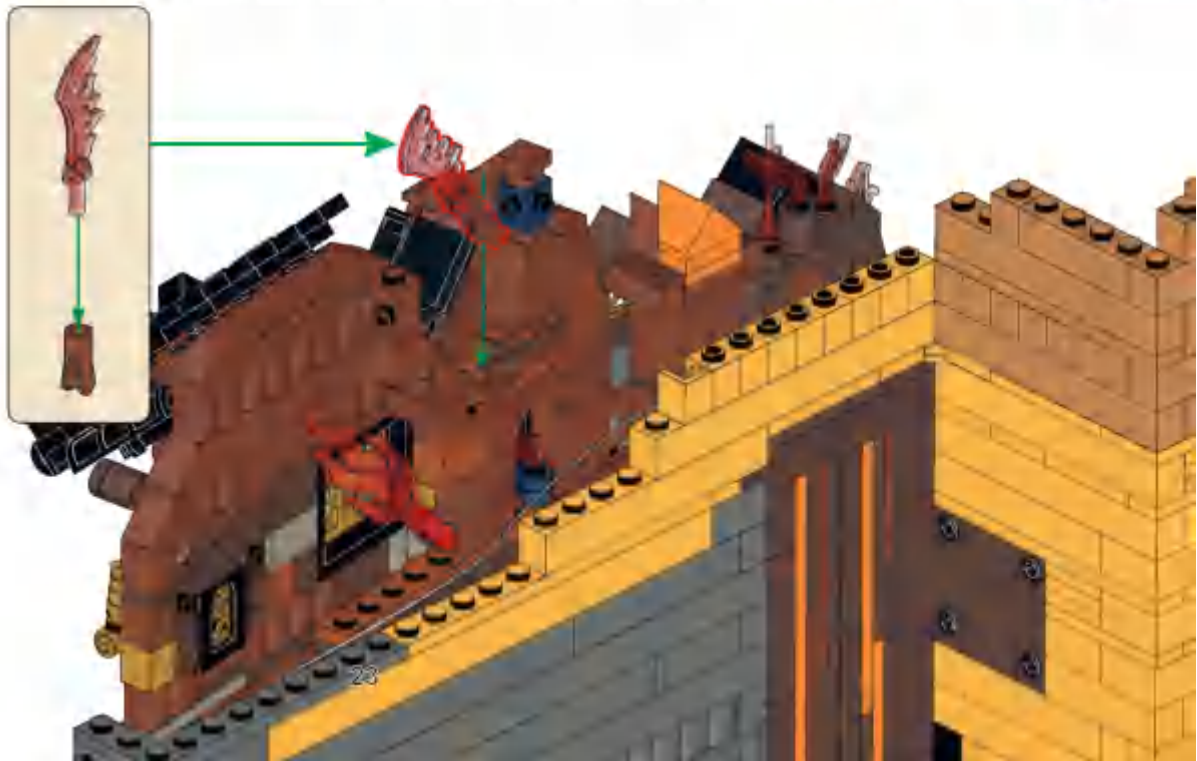



**F80**



**F81**



**F82**

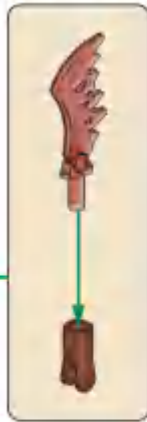
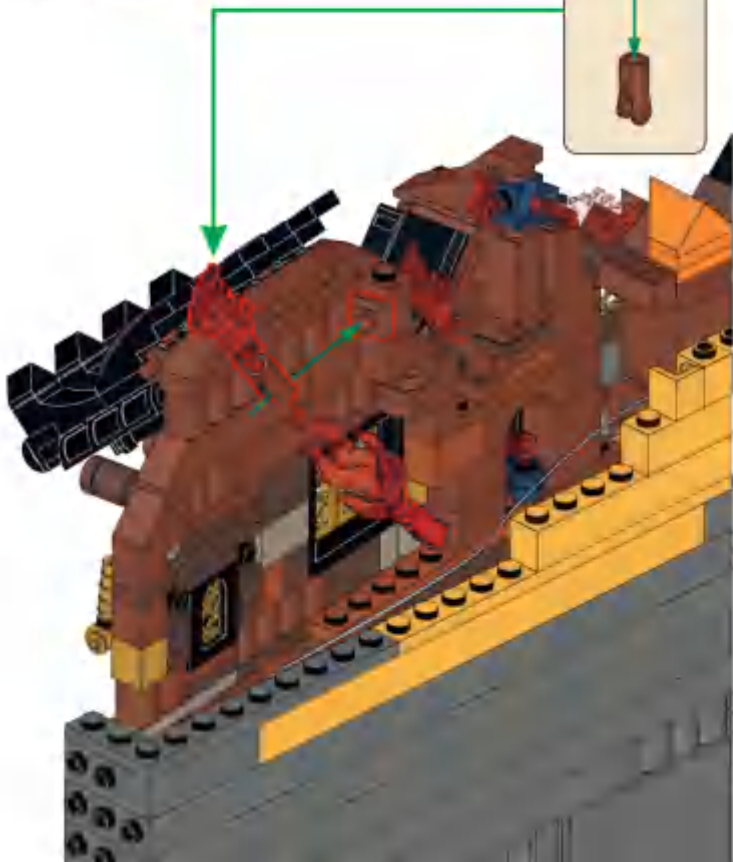

**F83**





**F84**

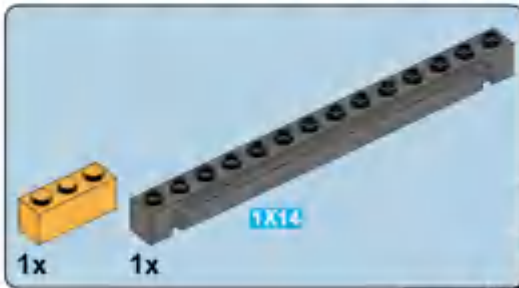

**F85**



**F86**



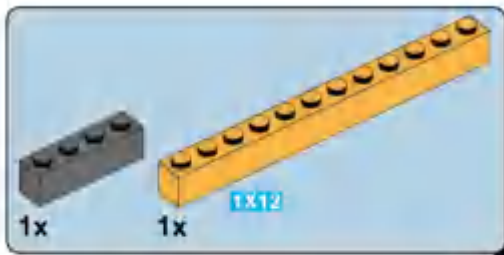

**F87**

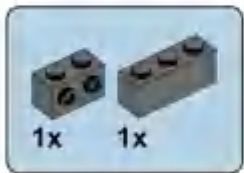
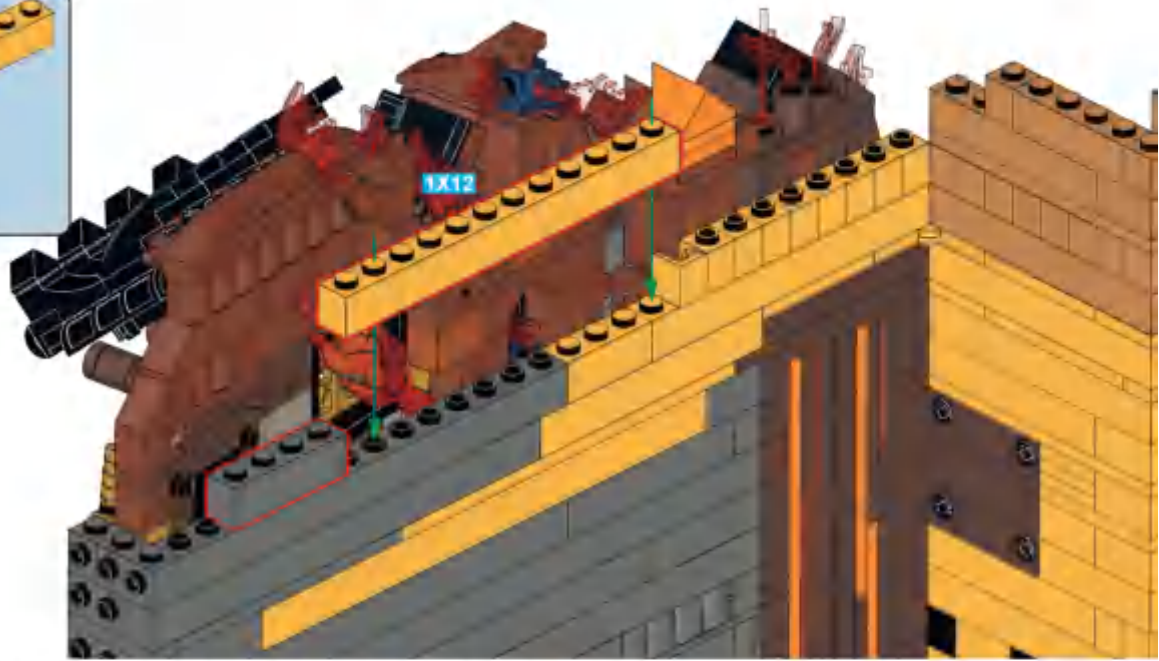

**F88**

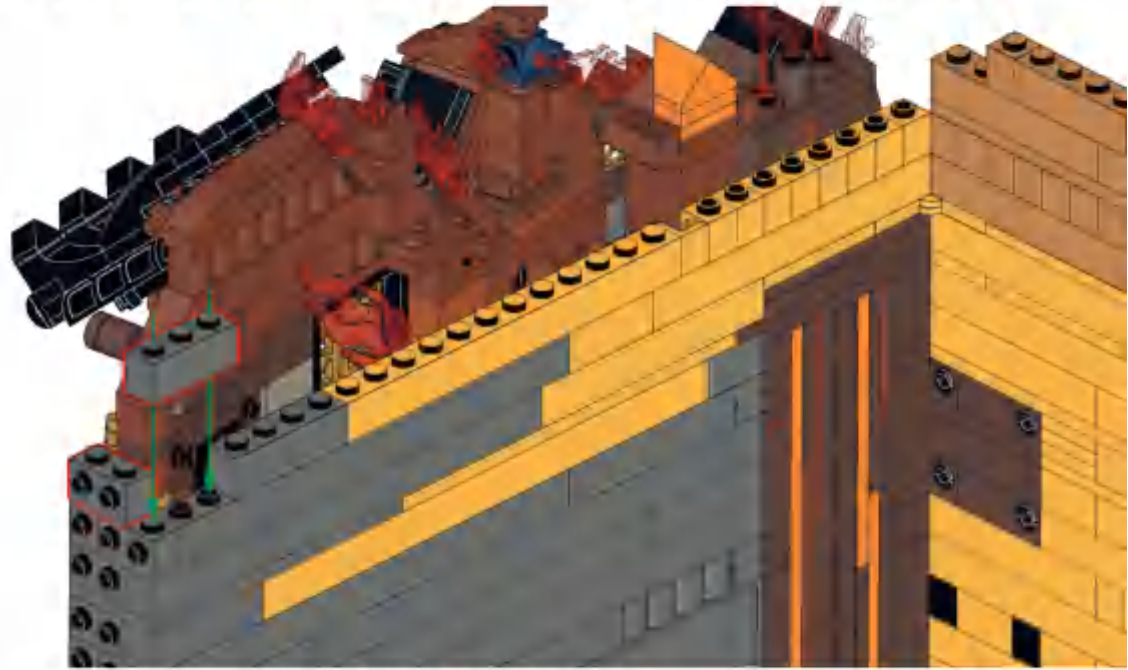

**F89**

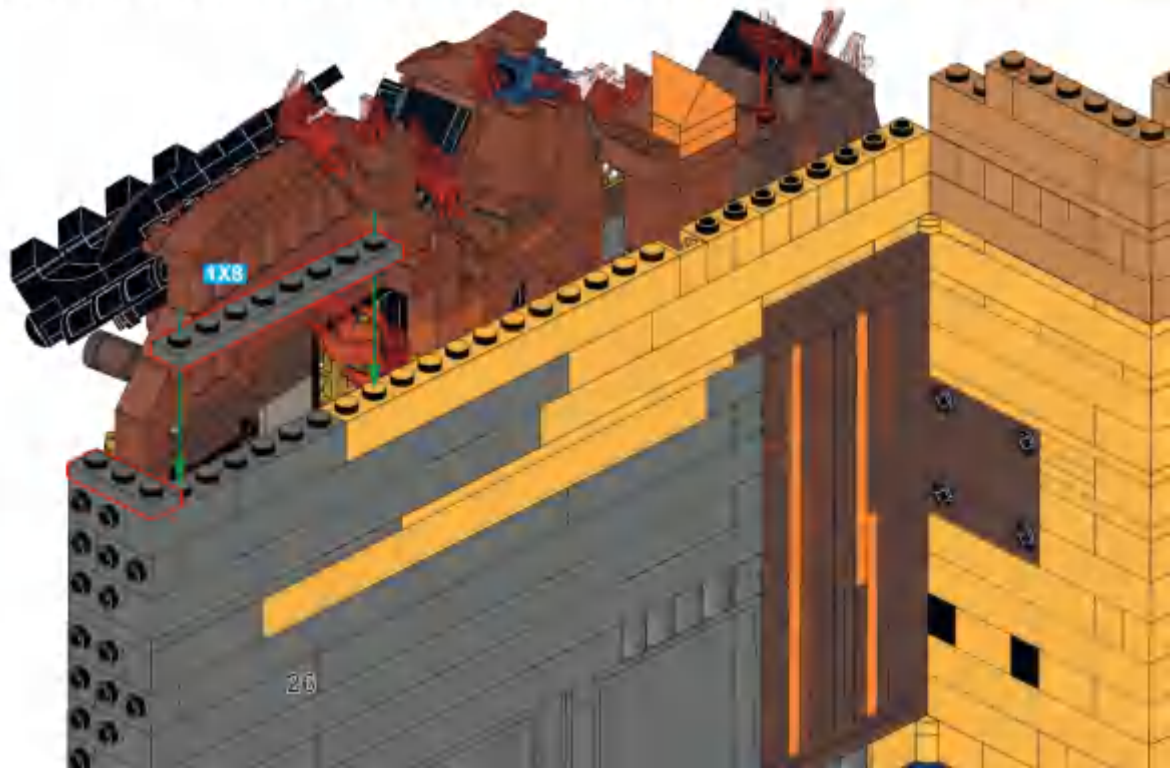

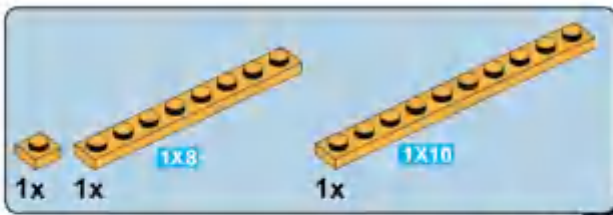

### F90

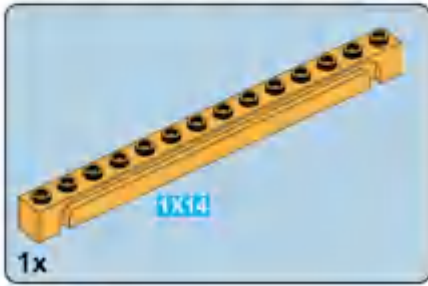
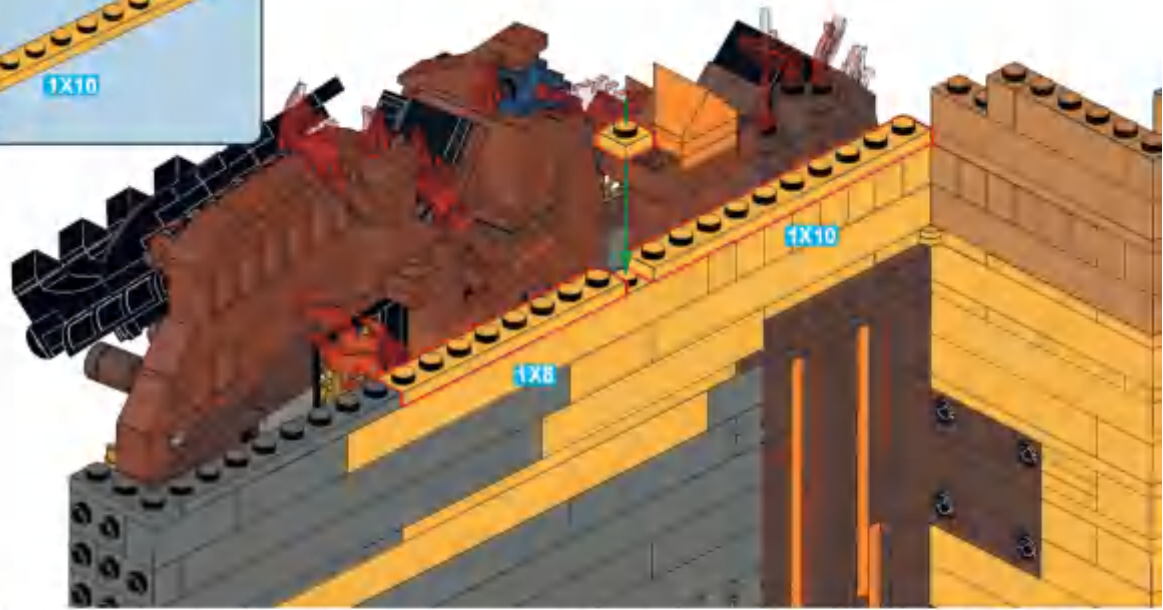

### F91

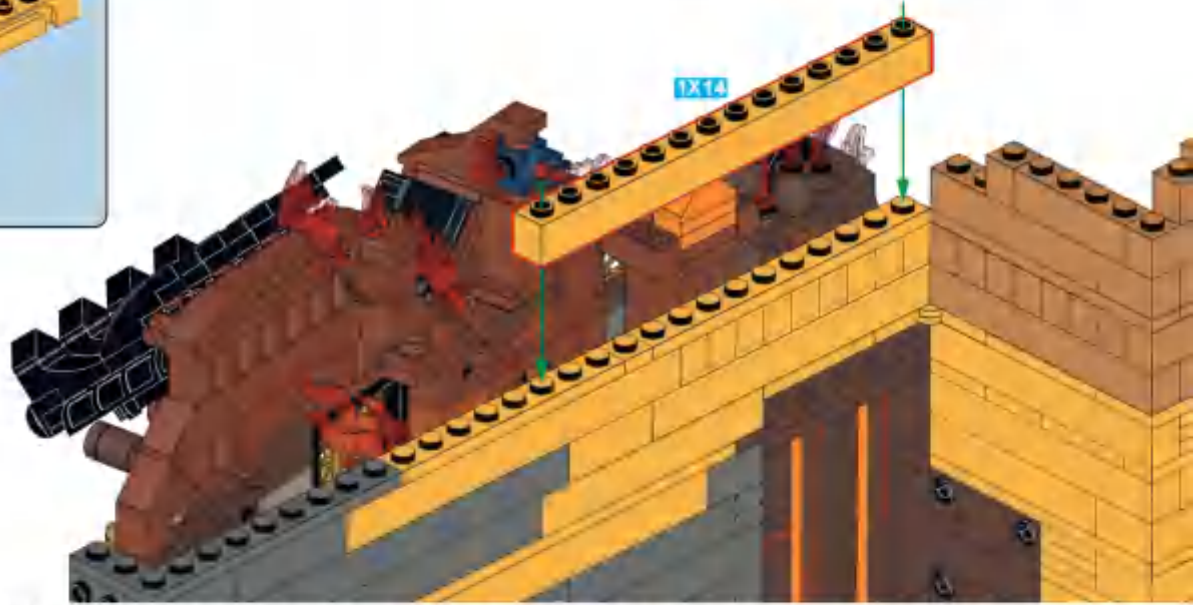

### F92

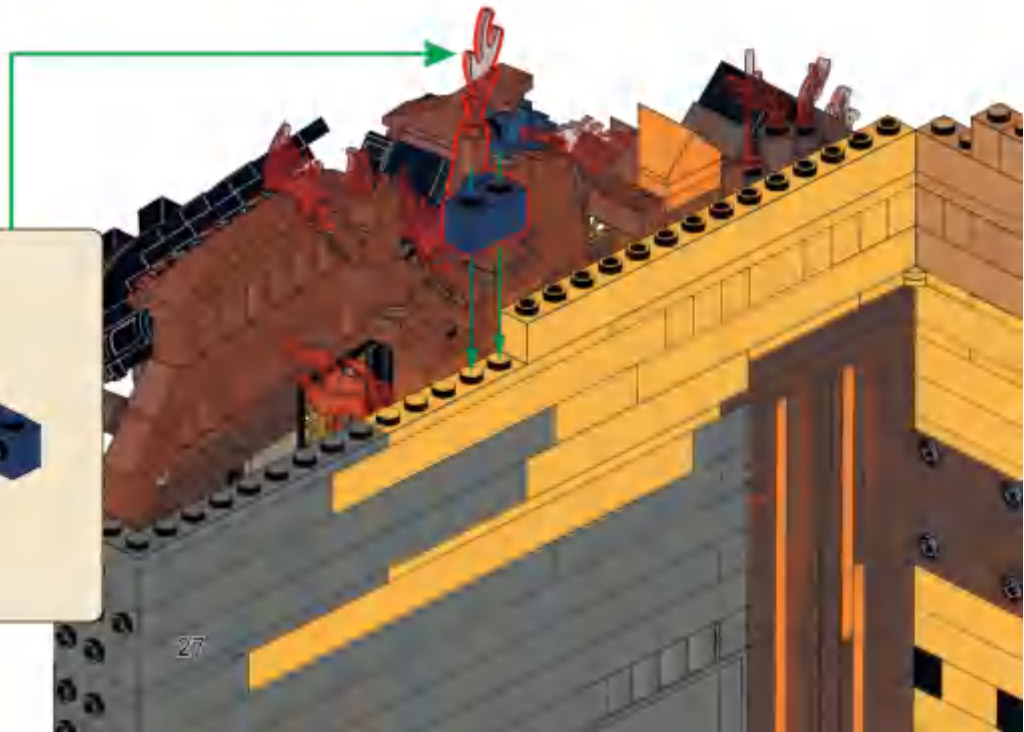
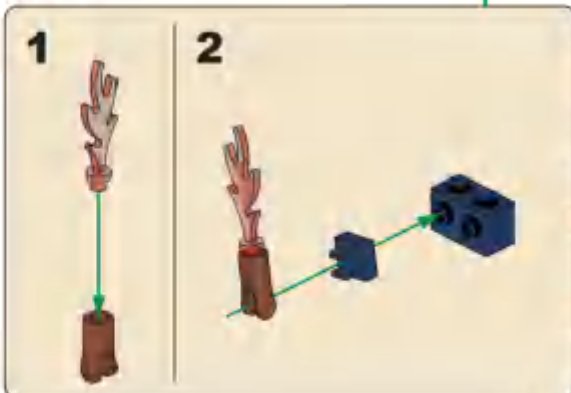

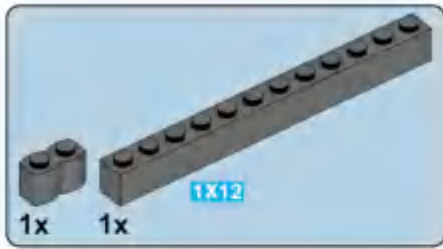

**F93**



**F94**

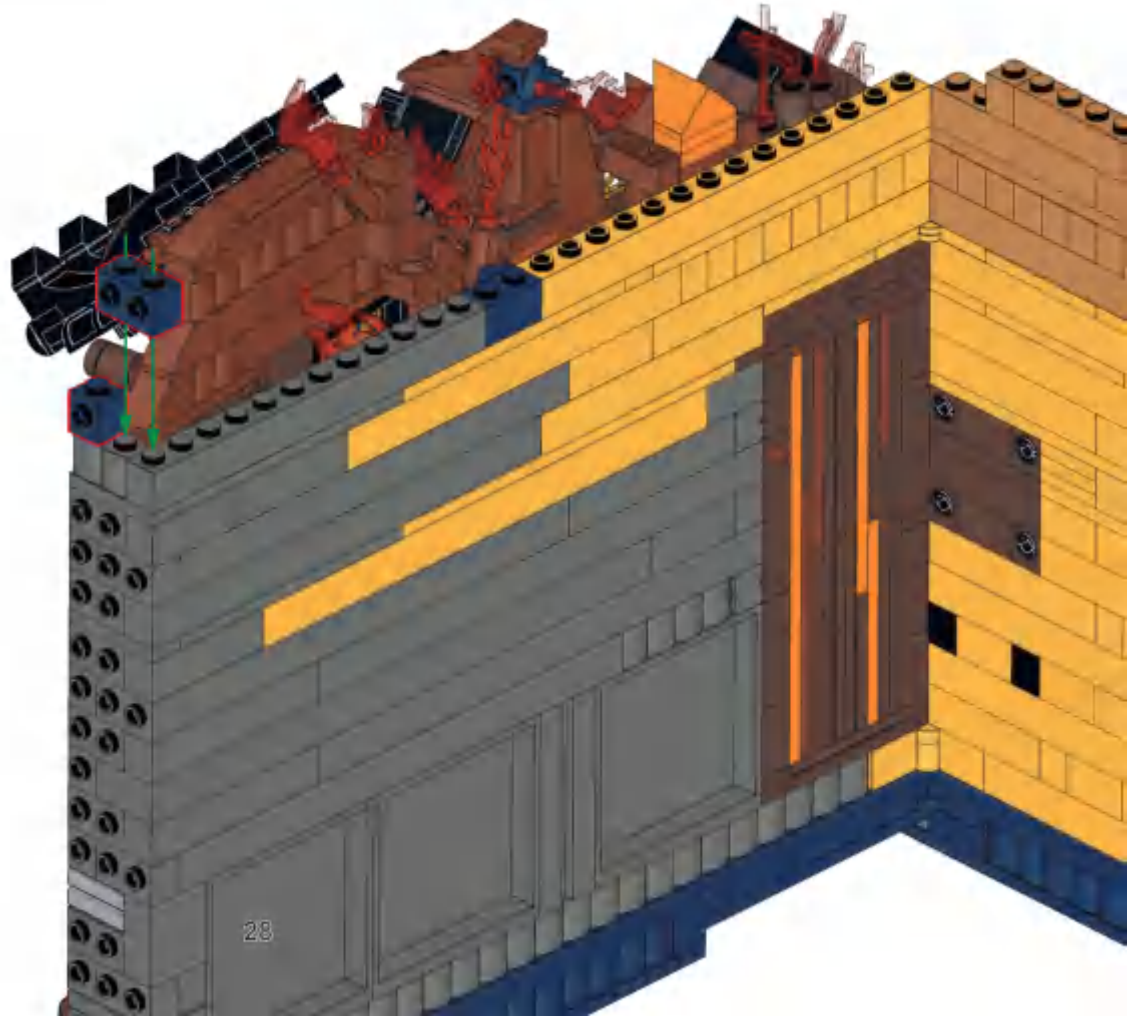

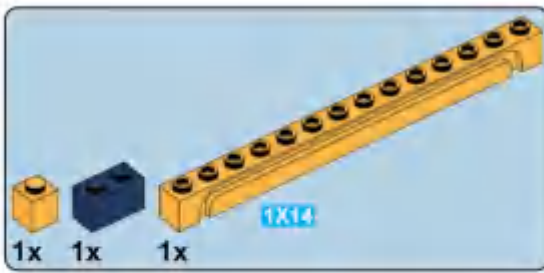

**F95**

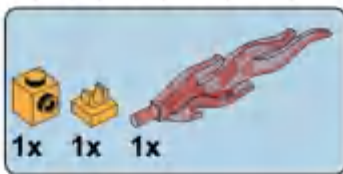

**F96**

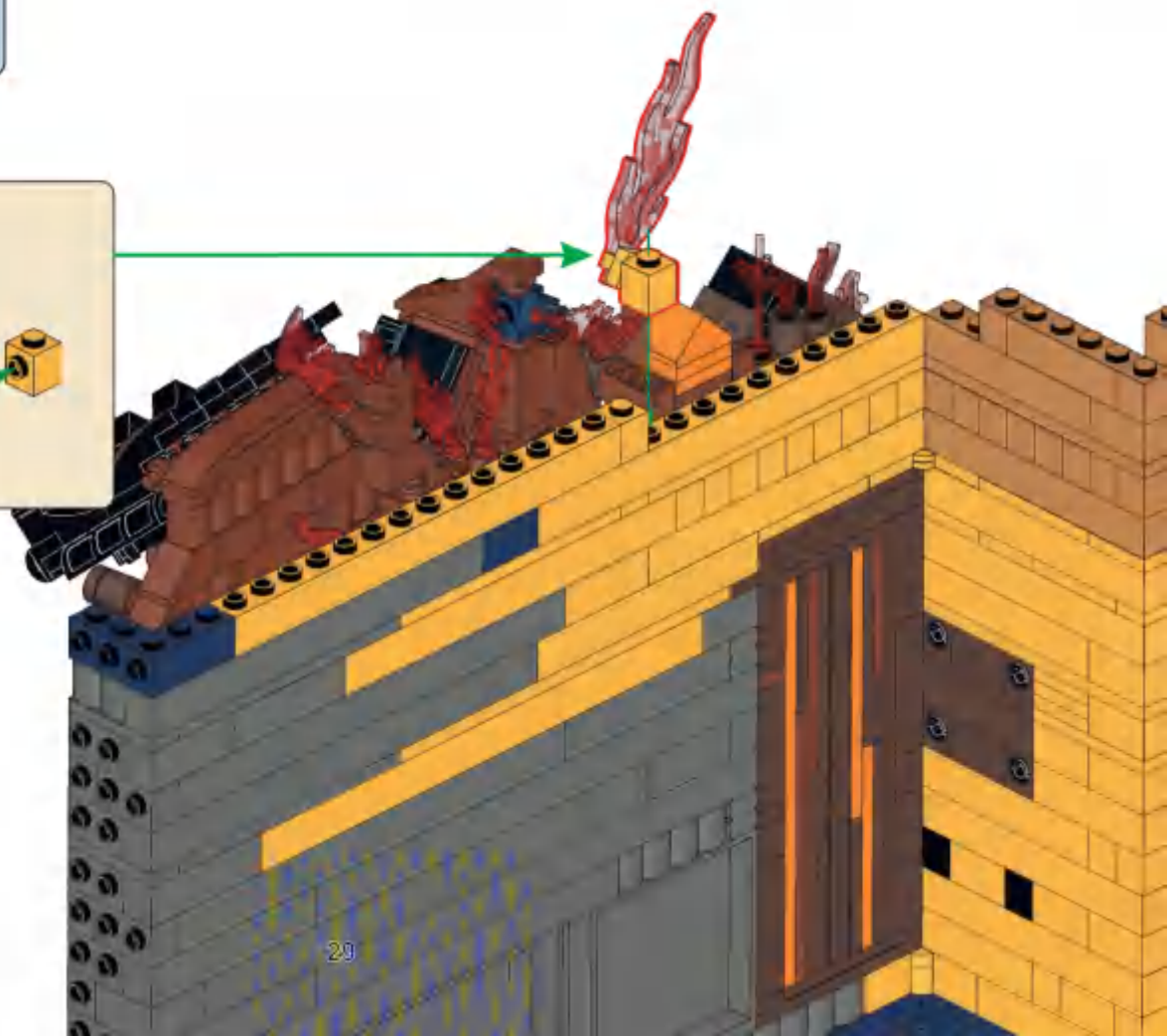
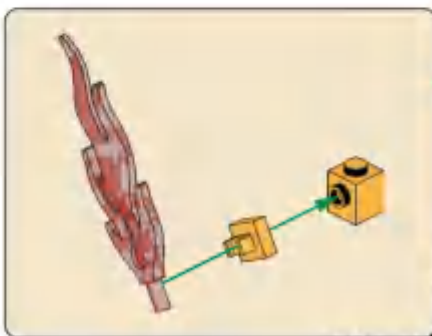

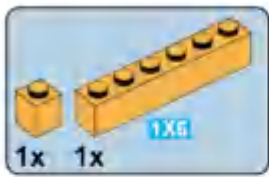

**F97**



**F98**

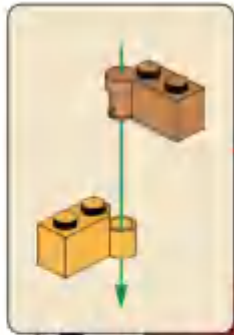

7



G



G1





**G2**

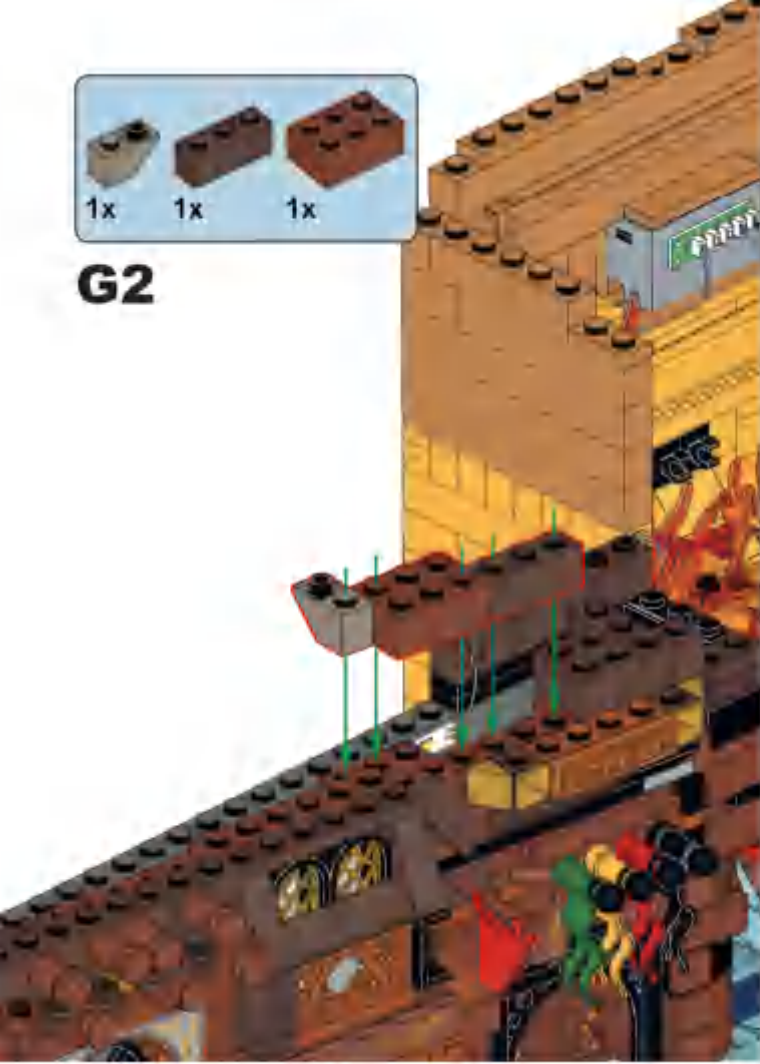

**G3**

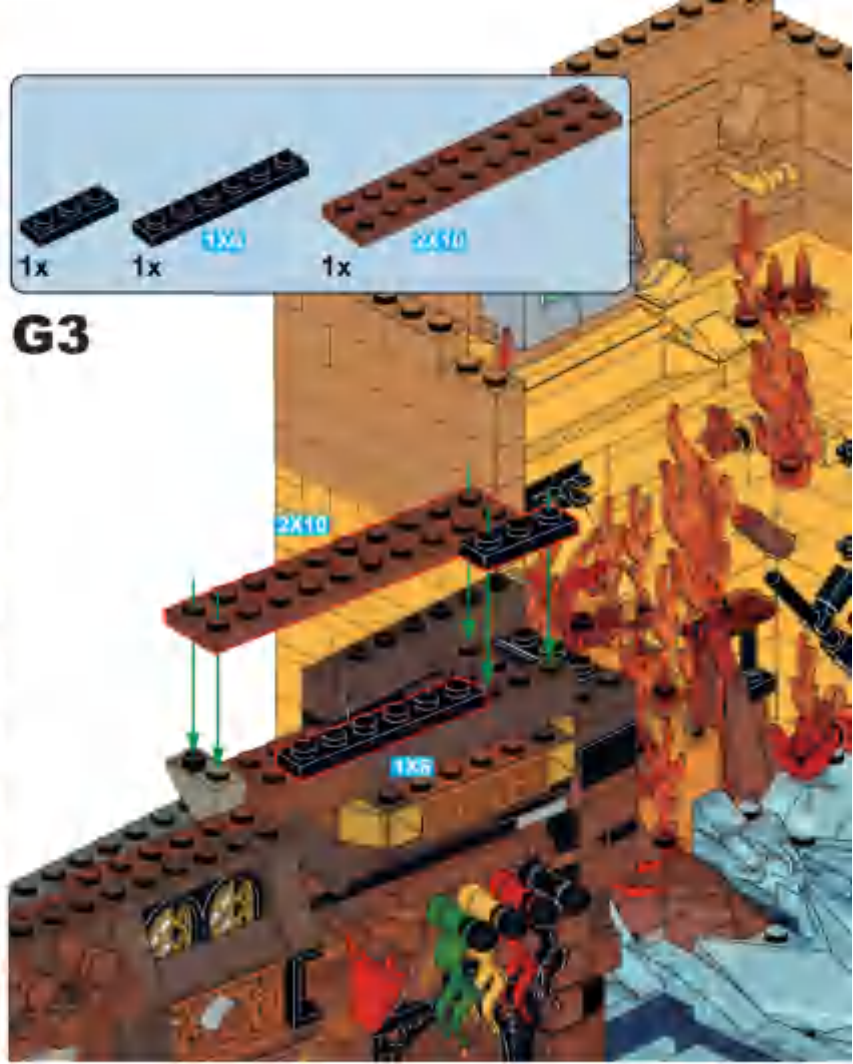

**G4**



**G5**

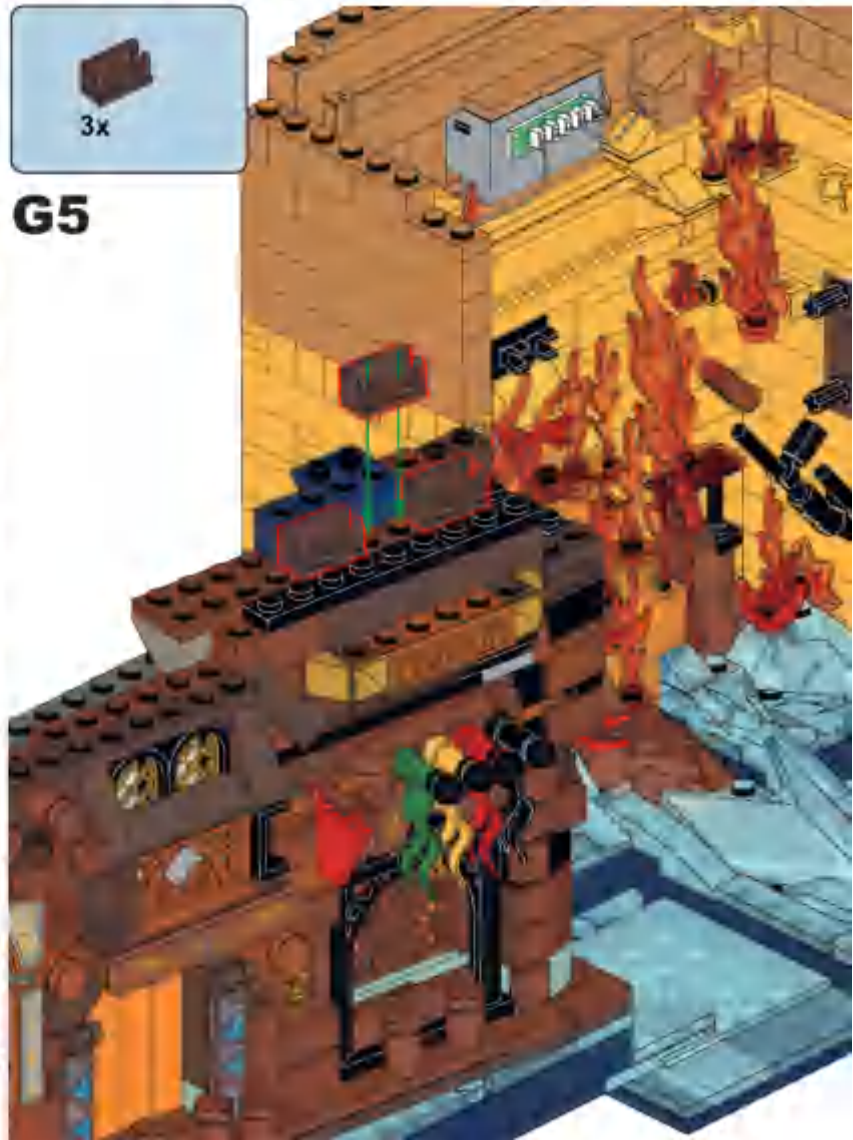



**G6**

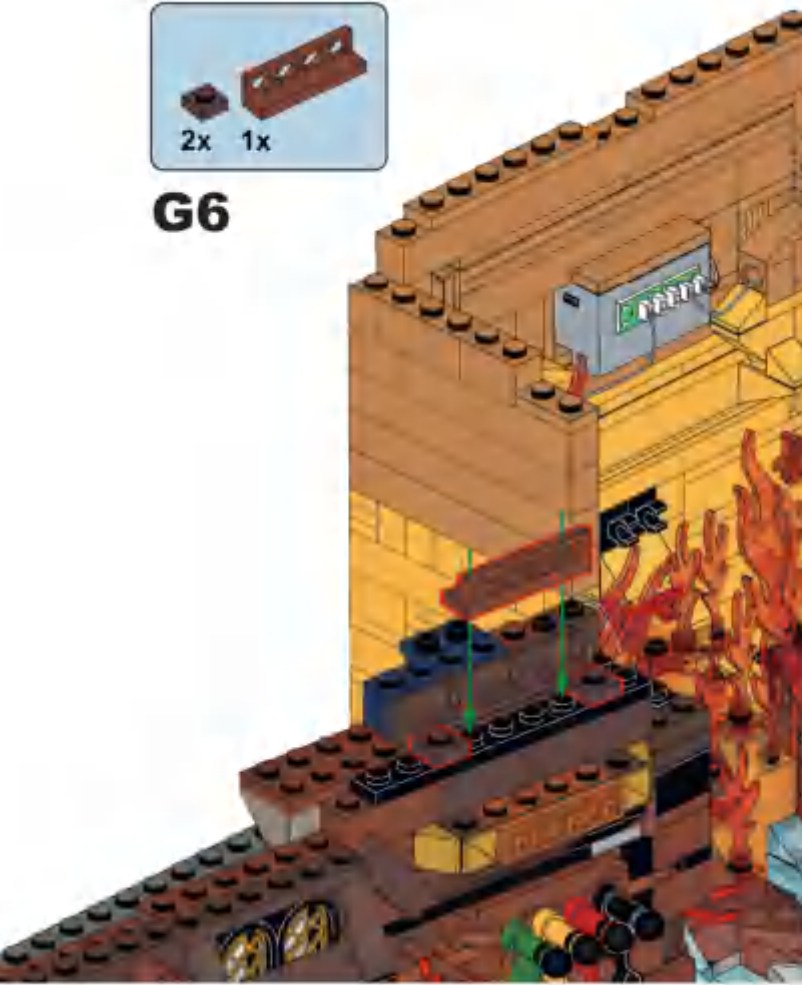

**G7**



**G8**

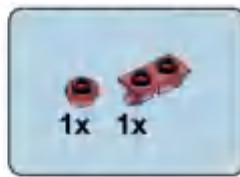

**G9**





**G10**

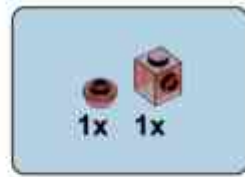

**G11**



**G12**



**G13**



**G14**

**G8**

**G13**

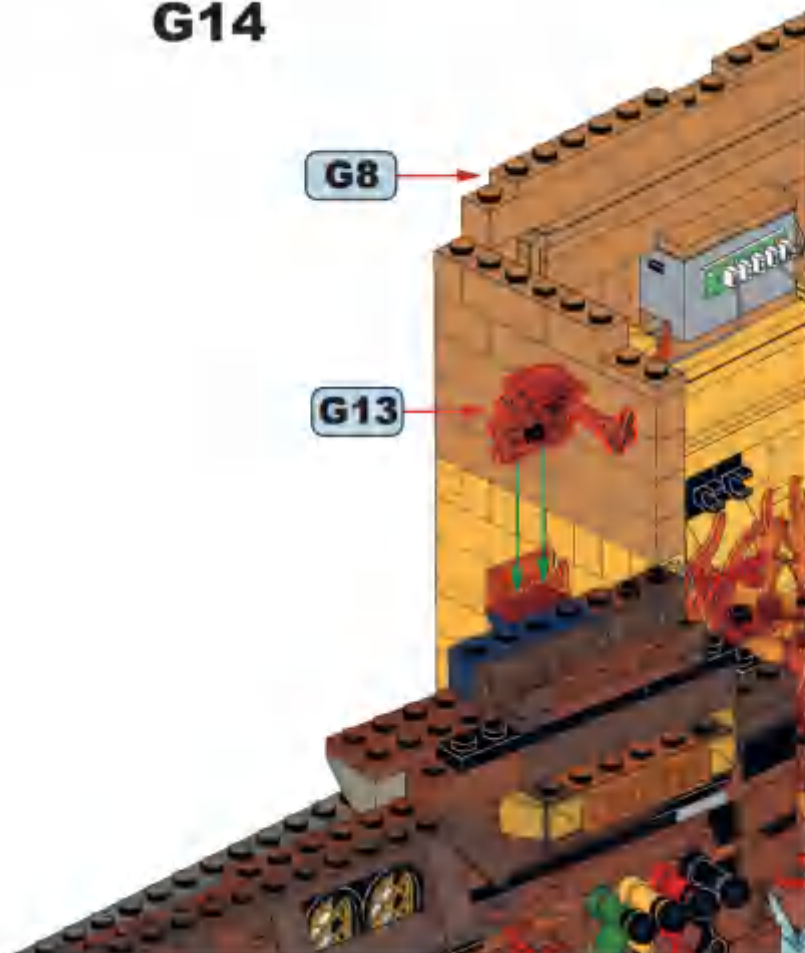

**G15**

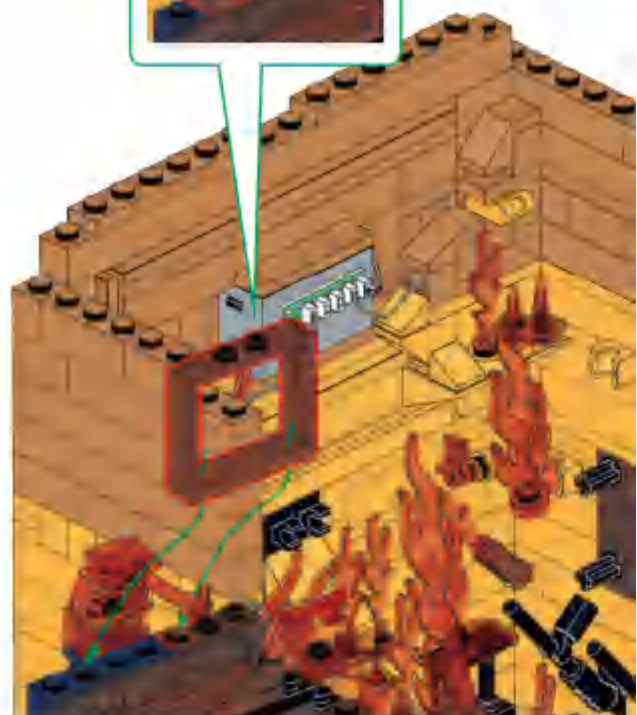

**G16**



**G17**





### G18

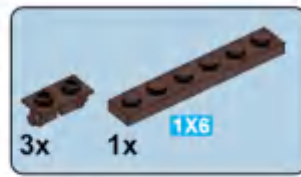

### G19

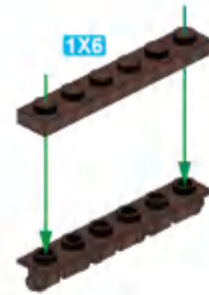

### G20

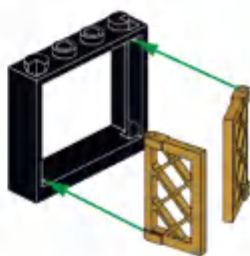

### G21

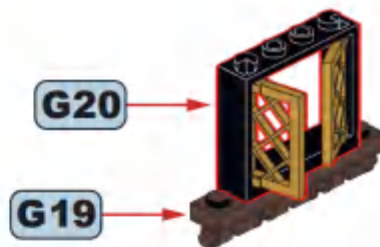



**G22**



**G23**



**G24**



**G25**

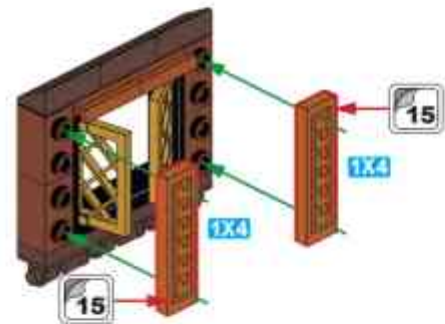

**G26**



**G27**





**G28**

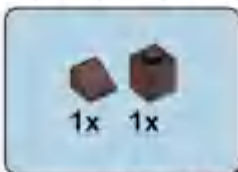

**G29**



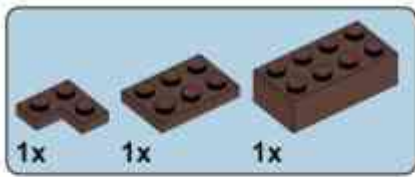

**G30**

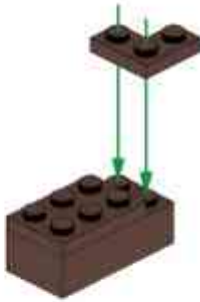

**G31**

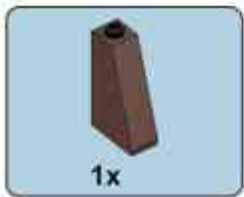
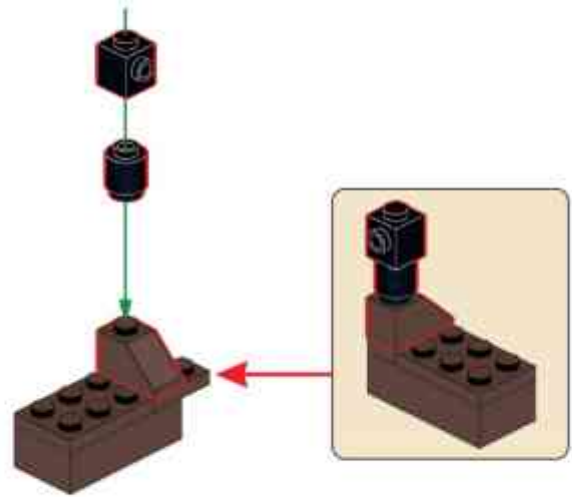

**G32**



**G33**





1x

**G34**



2x

**G35**



**G36**



**G35**

**G29**



**G37**



**G38**



**G39**



**G40**

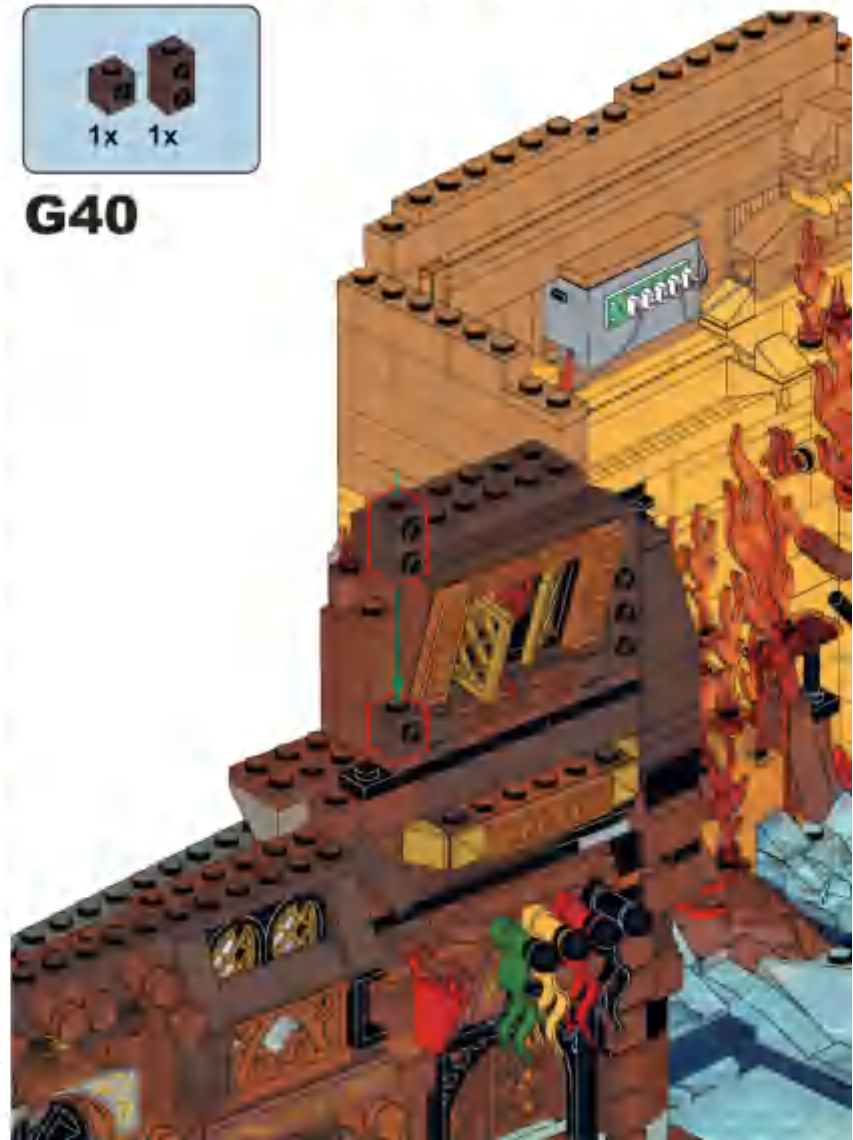



**G41**

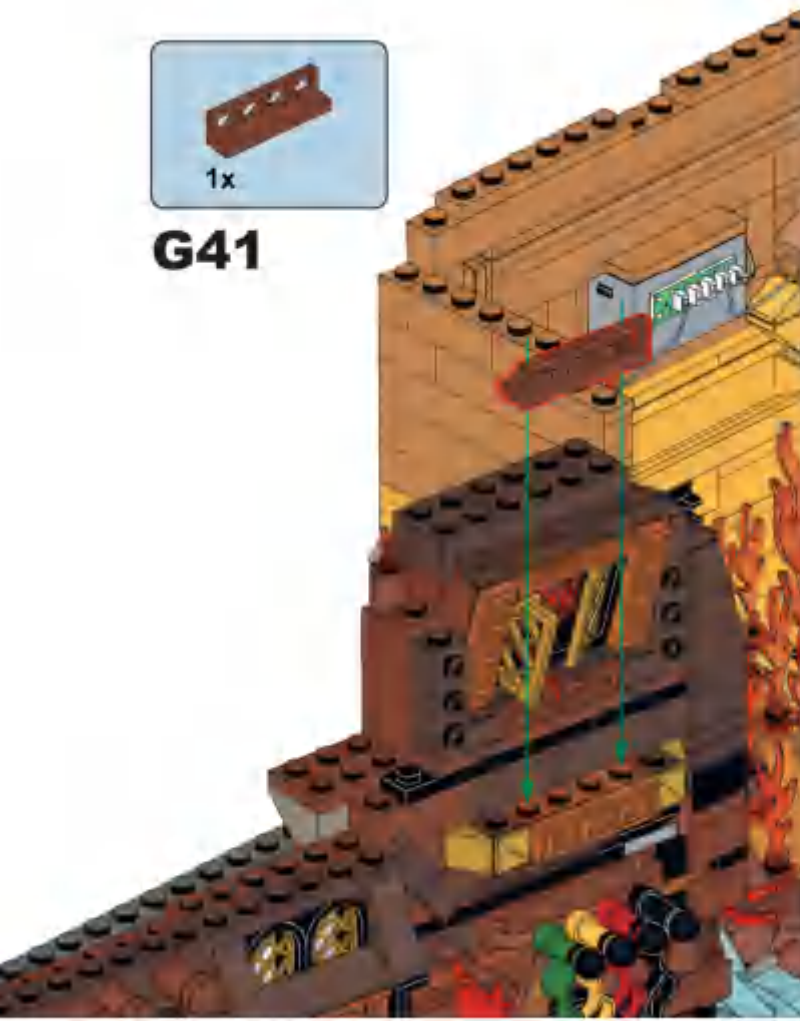

**G42**



**G43**



**G44**





**G45**



**G46**



**G47**



**G48**

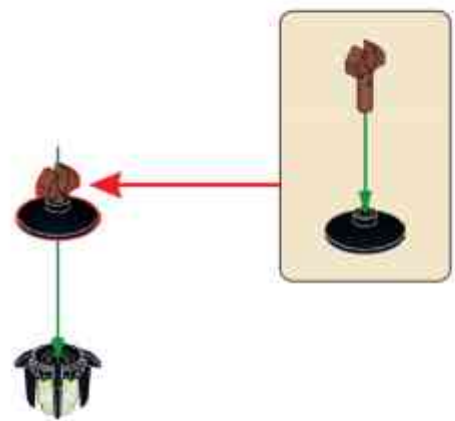

**G49**



**G50**

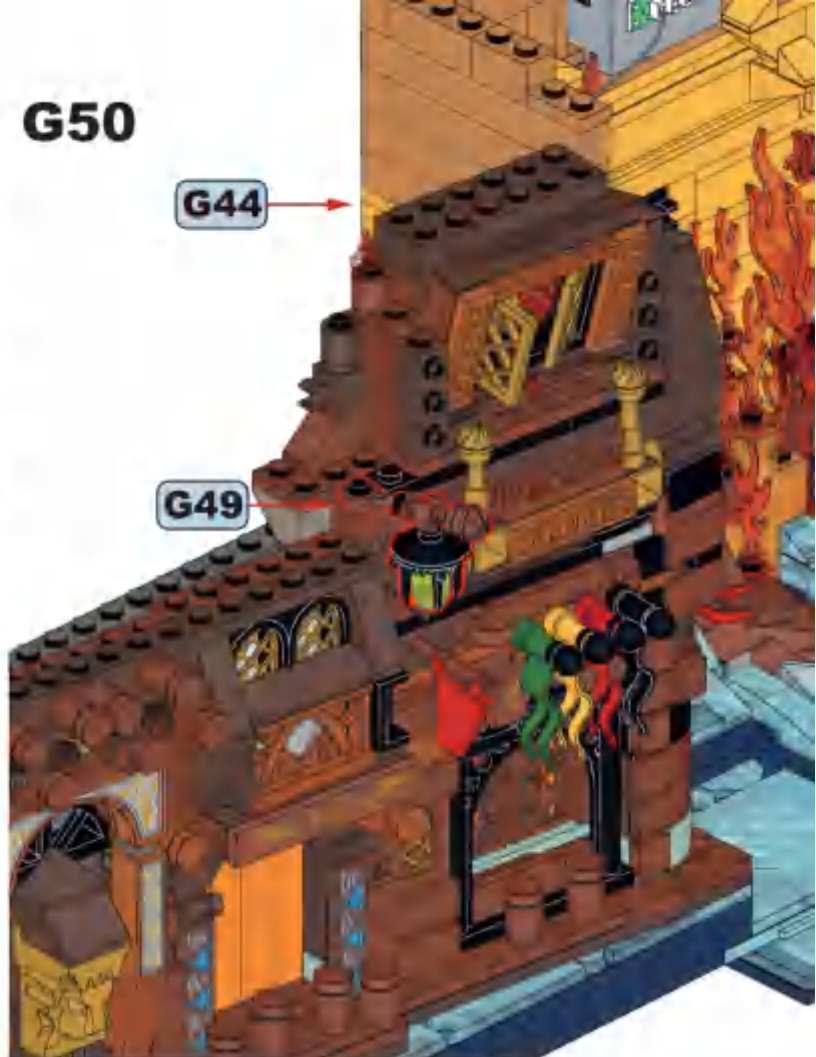

**G51**



**G52**





**G53**



**G54**

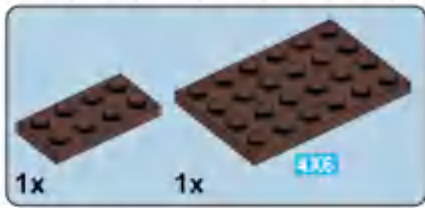

**G55**

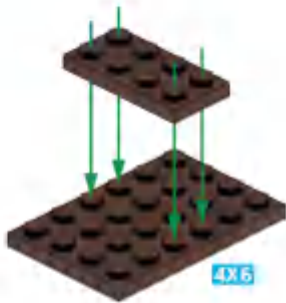

**G56**

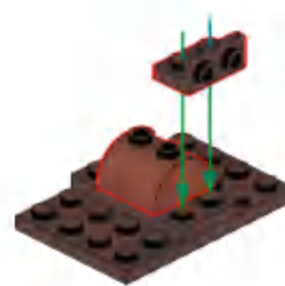



**G57**

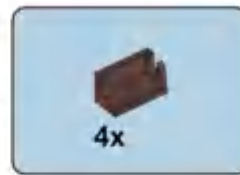
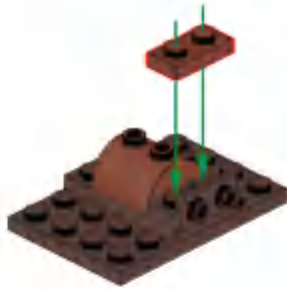

**G58**

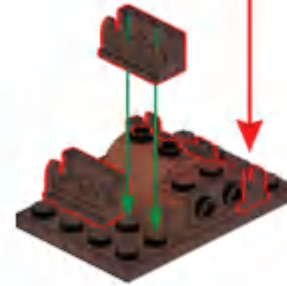
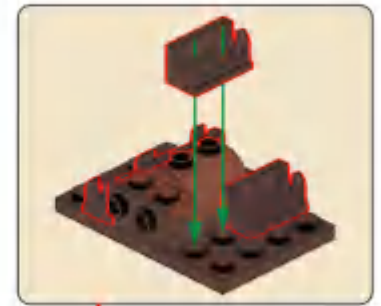

**G59**

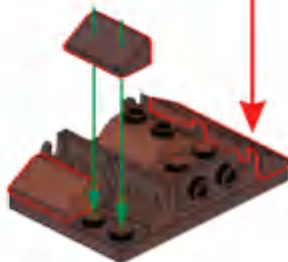

**G60**



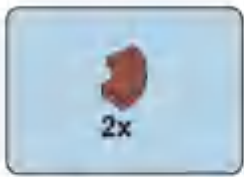

**G61**



**G62**



**G63**



**G64**





**G65**



**G66**



**G67**



**G68**





**G69**



**G70**



**G71**



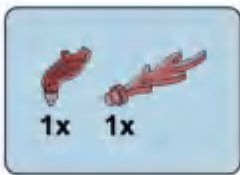

**G72**

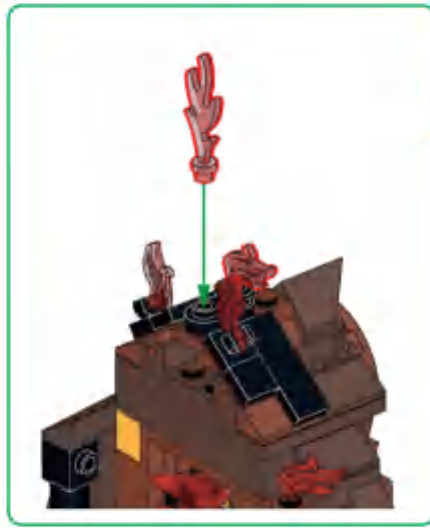

**G73**



**G74**

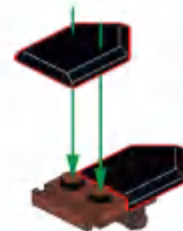



**G75**



**G76**



**G77**



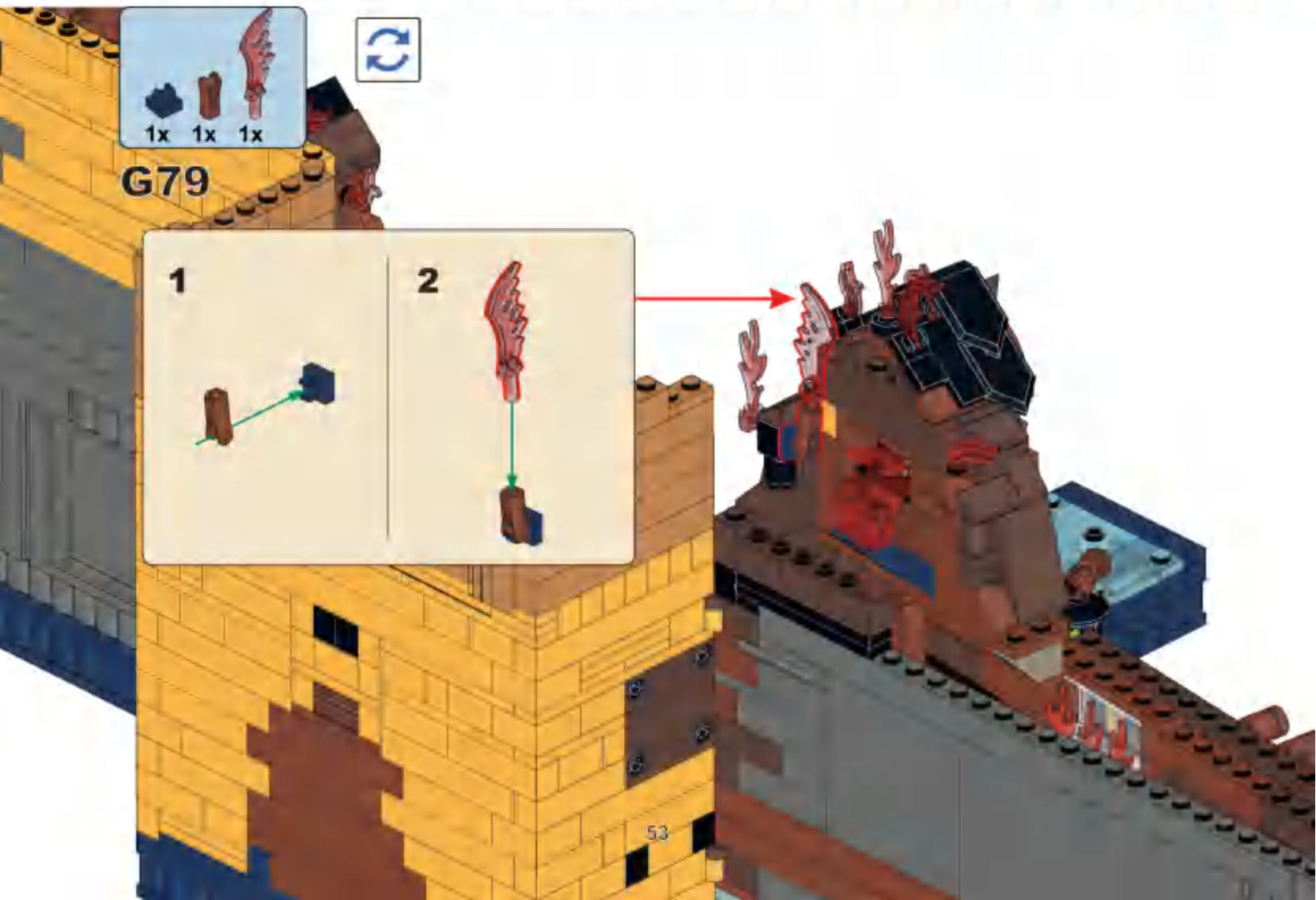

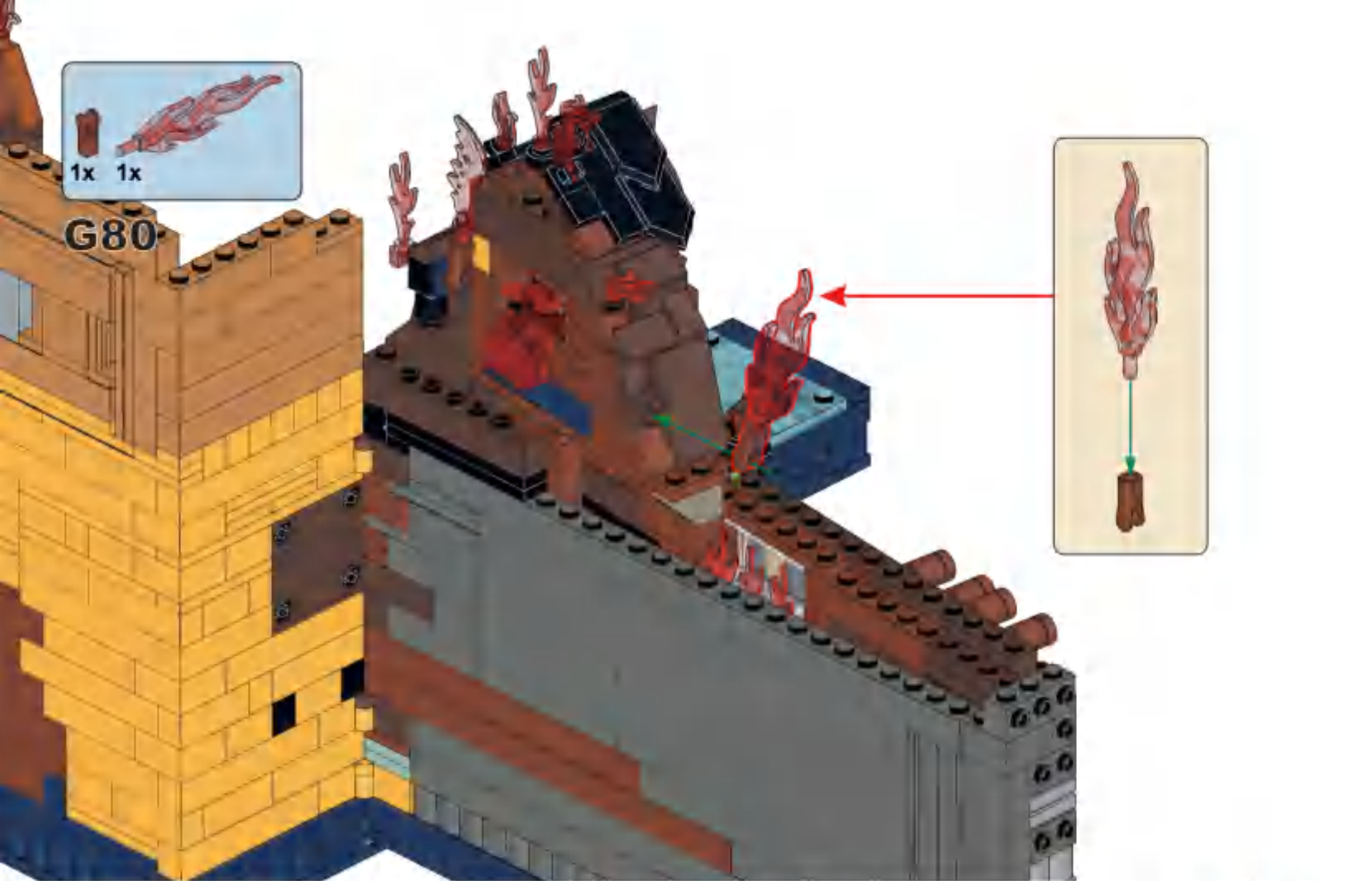



**G83**

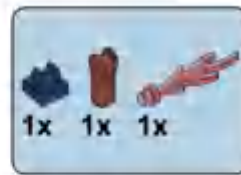

**G84**

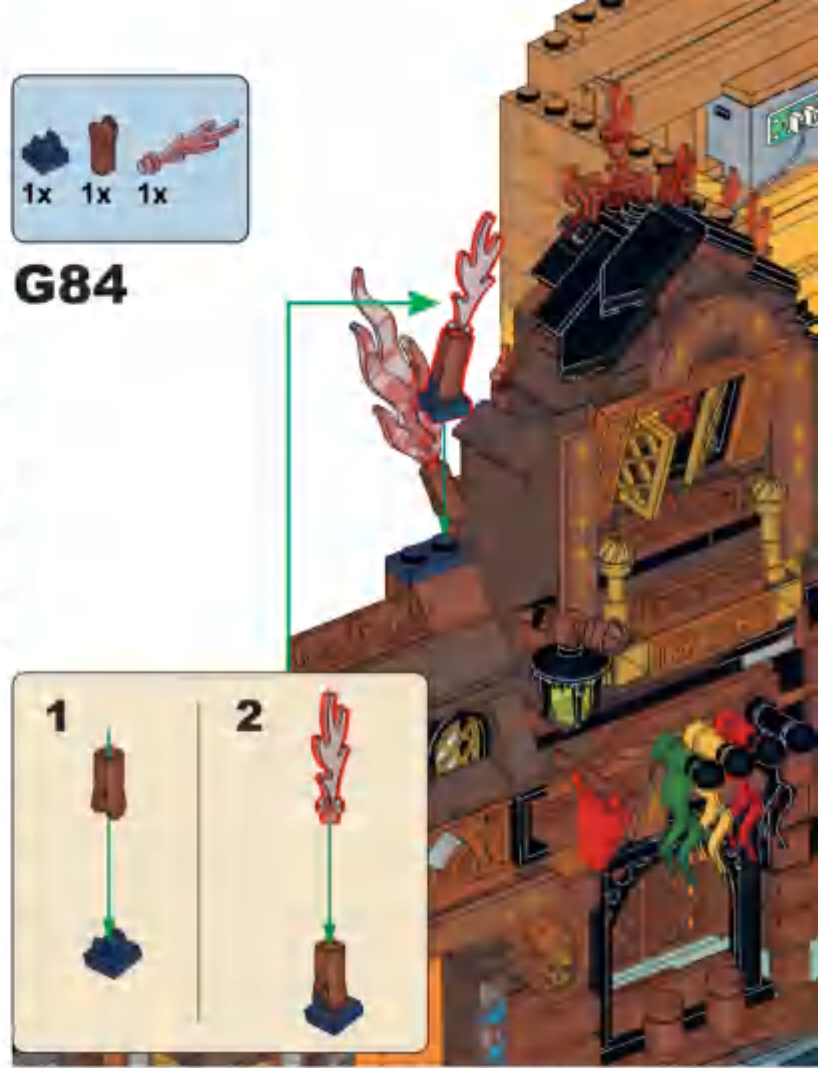

**G85**

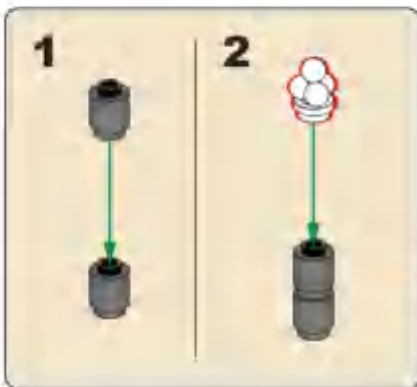

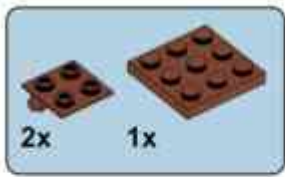

**G86**

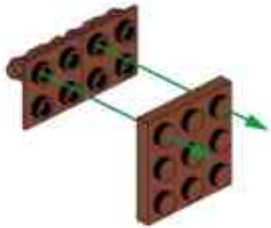

**G87**

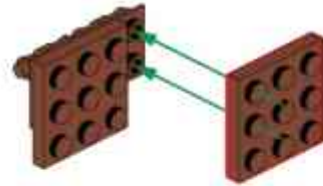

**G88**

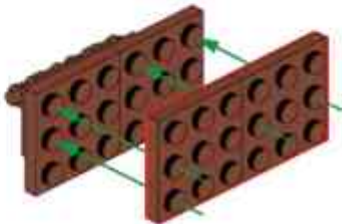

**G89**

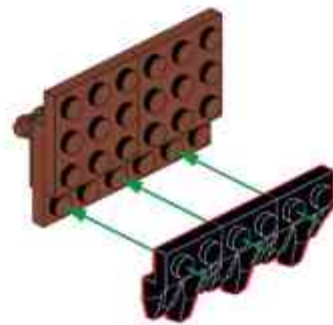

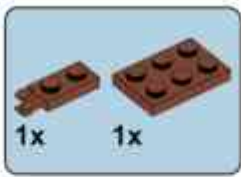

**G90**

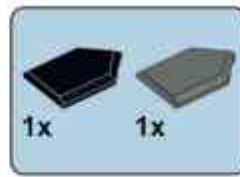
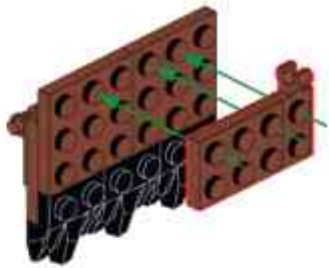

**G91**

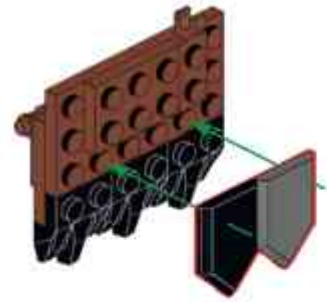

**G92**

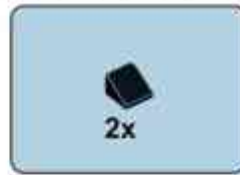
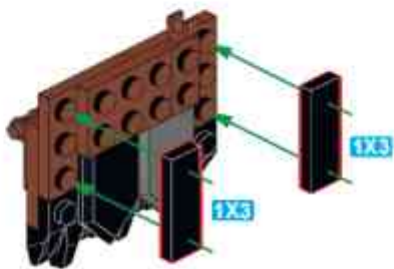

**G93**

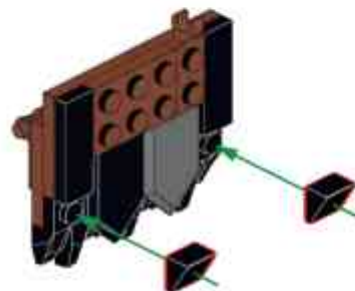

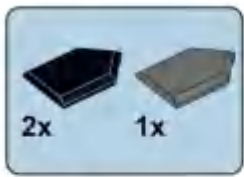

**G94**

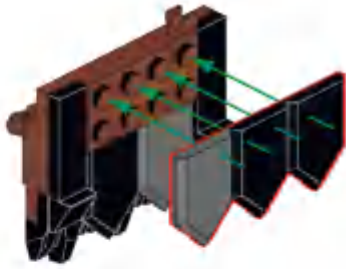

**G95**



**G96**

**G85**

**G95**

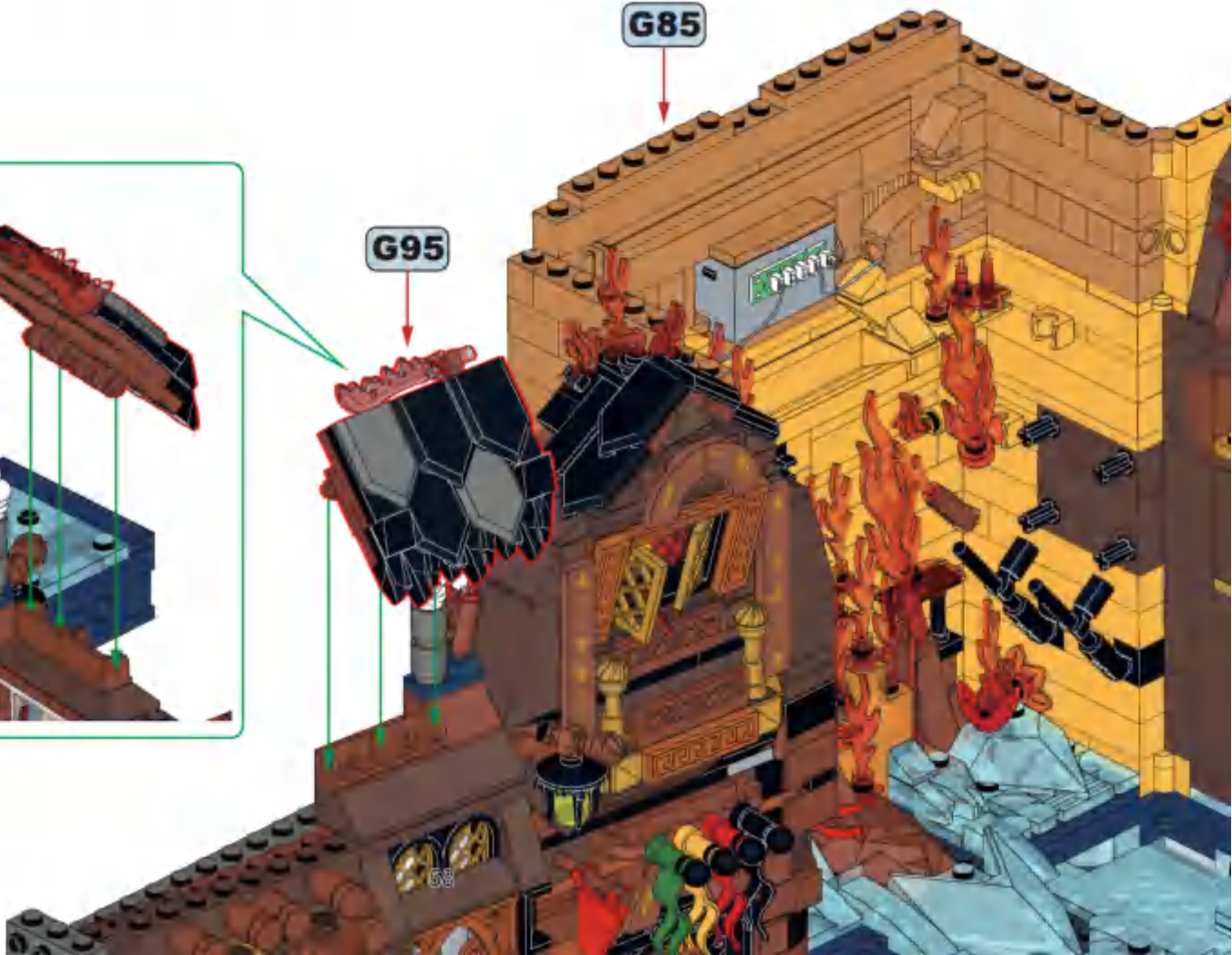
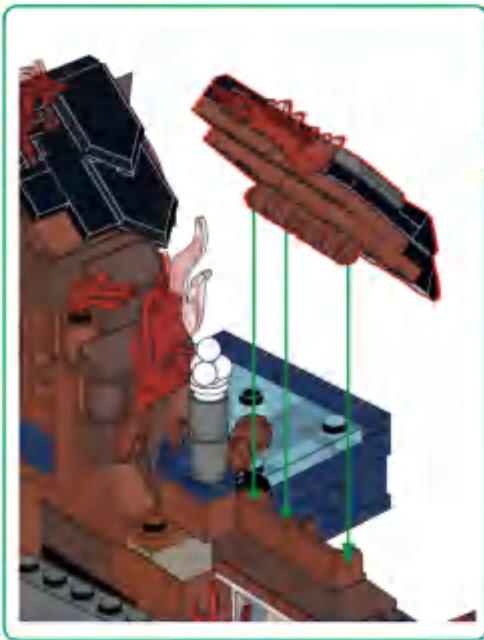

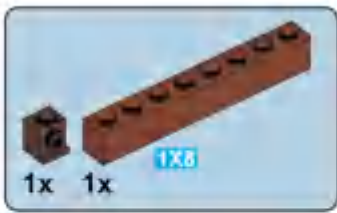

**G97**

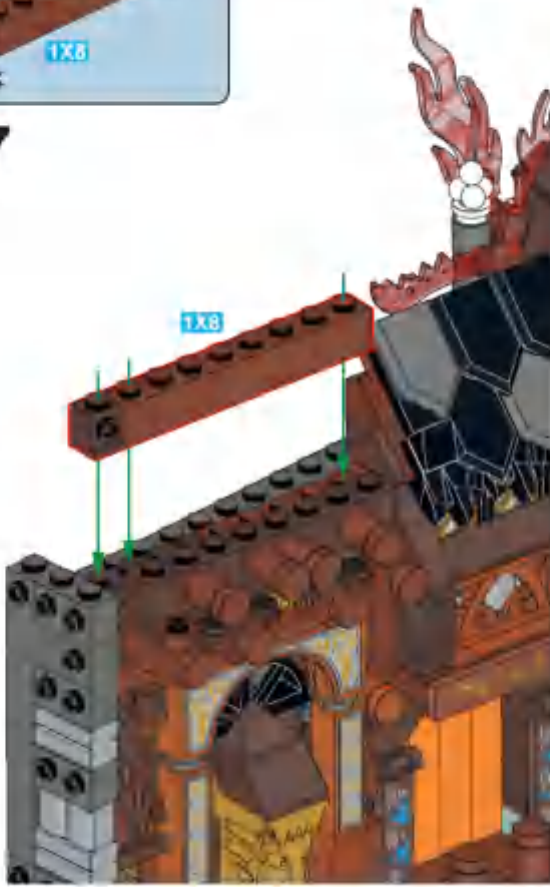

**G98**

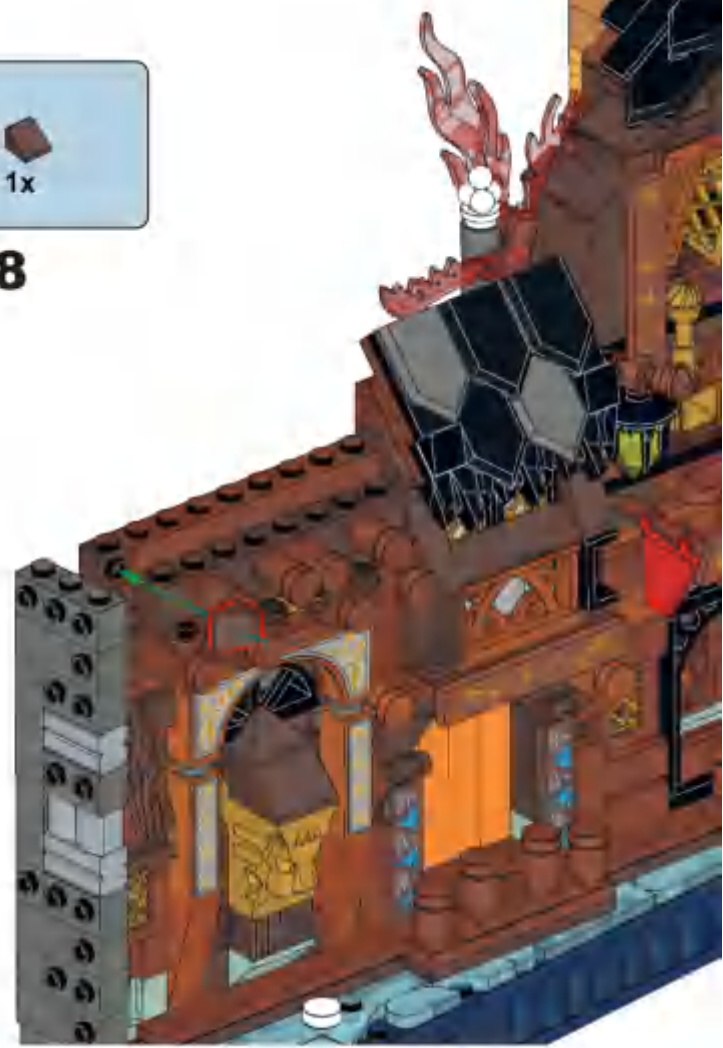

**G99**

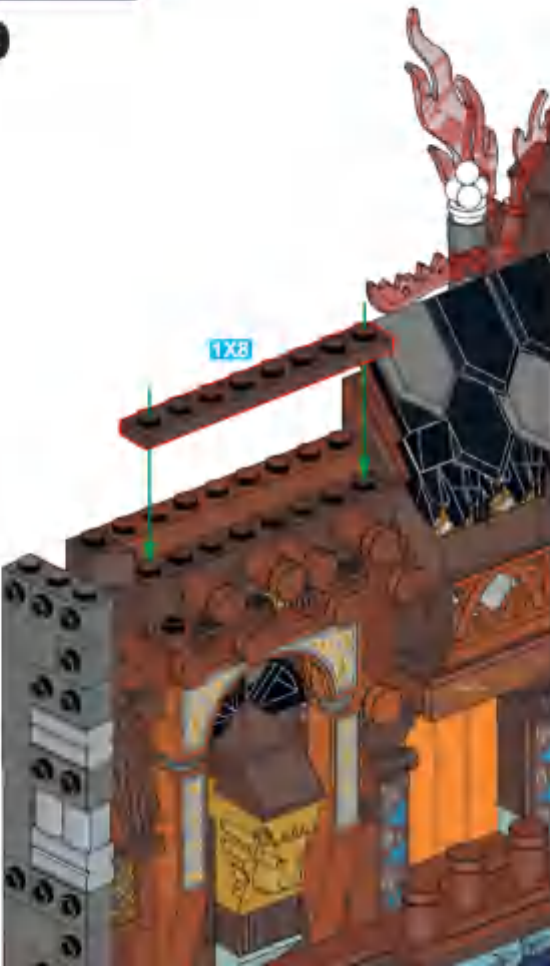

**G100**

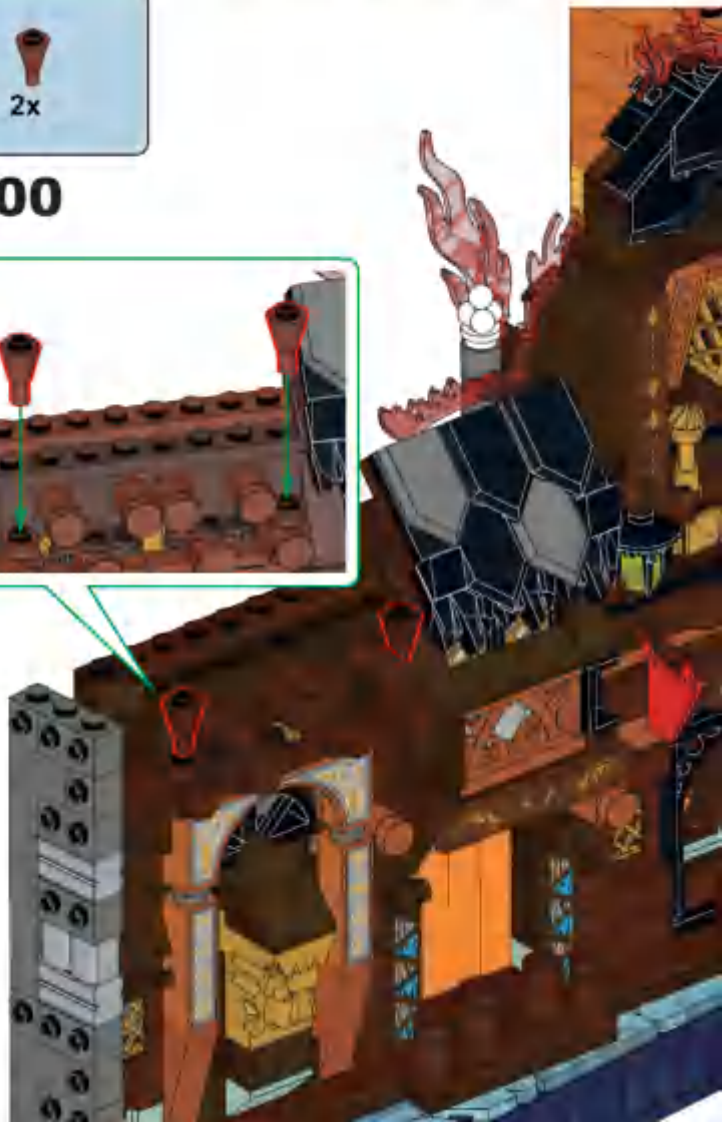
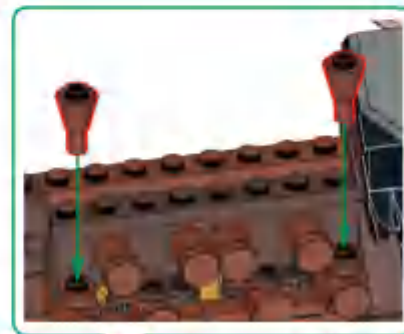



**G101**



**G102**



**G103**

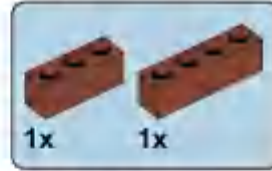
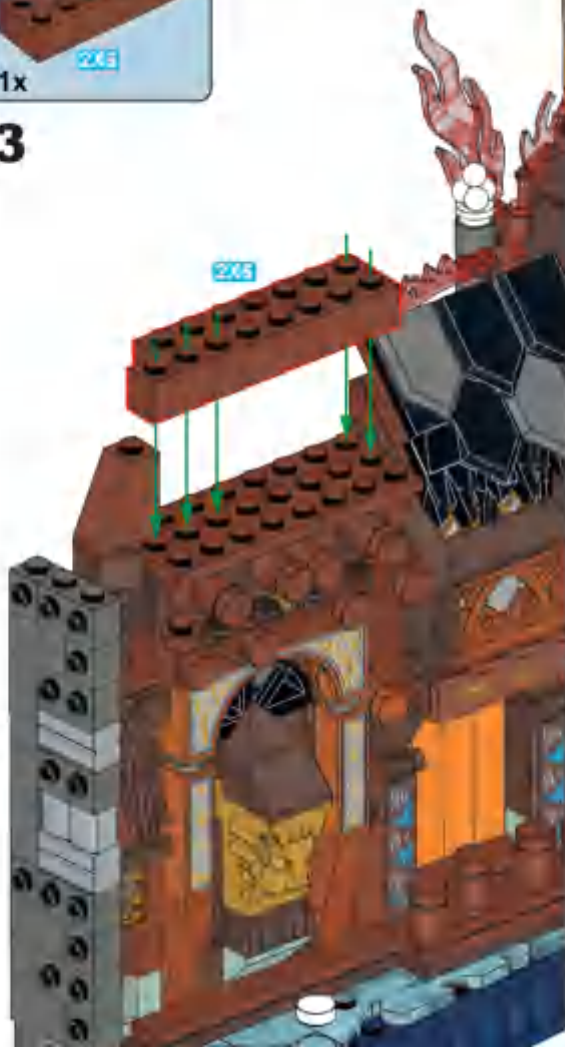

**G104**



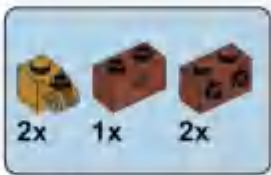

**G105**



**G106**

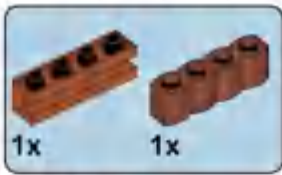

**G107**



**G108**





**G109**



**G110**



**G111**



**G112**

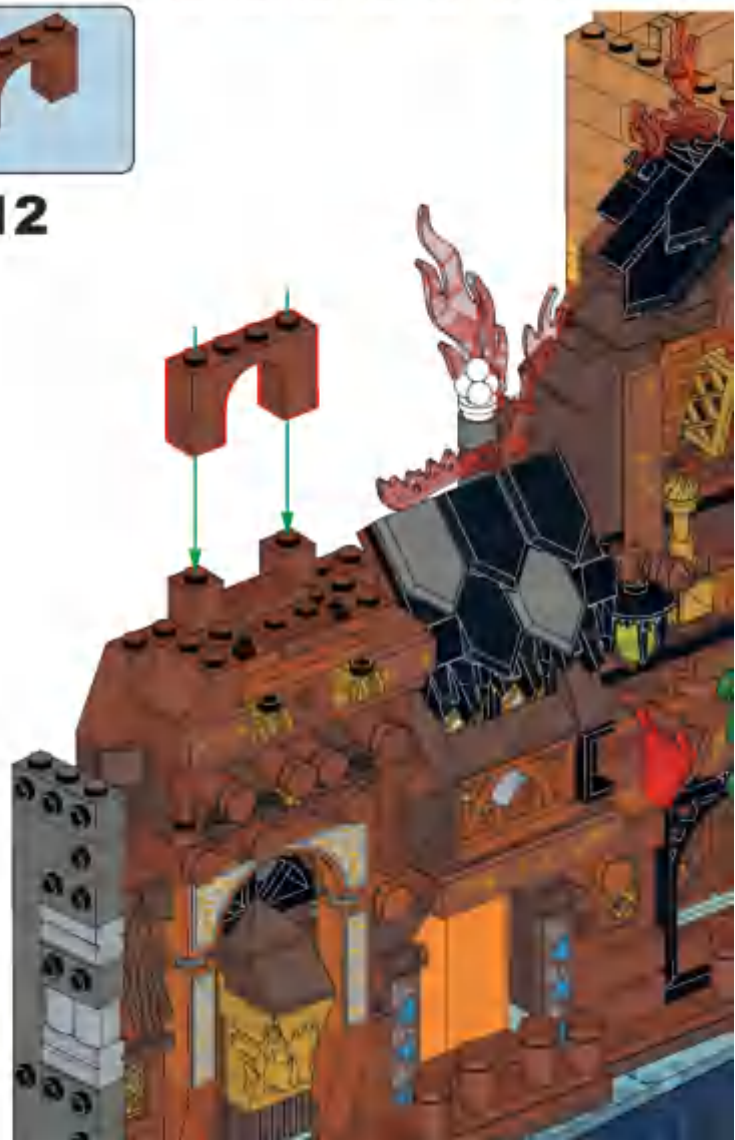



**G113**



**G114**



**G115**



**G116**





**G117**



**G118**



**G119**

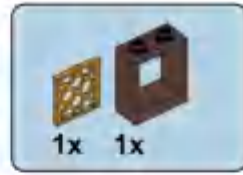

**G120**





**G121**



**G122**

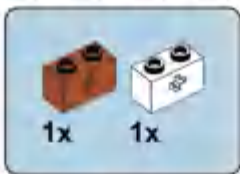

**G123**



**G124**





**G125**



**G126**



**G127**



**G128**





**G129**

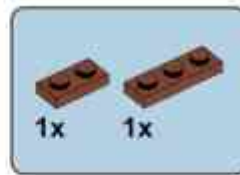

**G130**

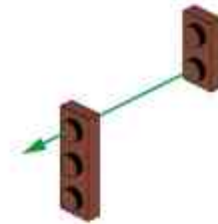

**G131**

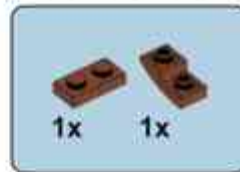
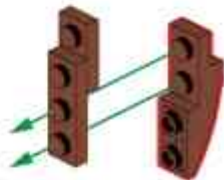

**G132**



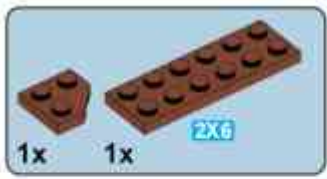

**G133**

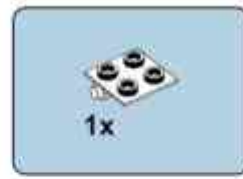
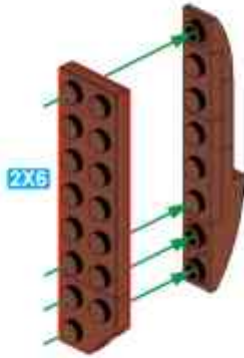

**G134**

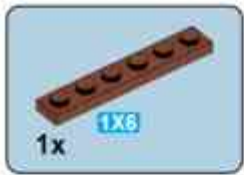
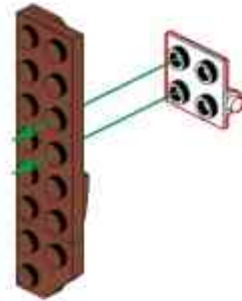

**G135**

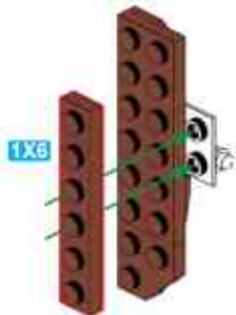

**G136**

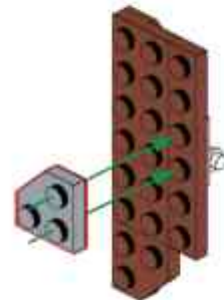

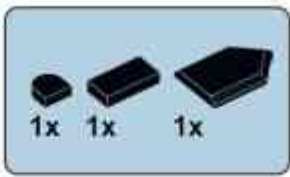

**G137**

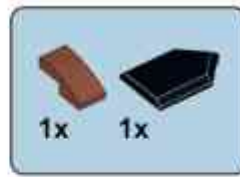
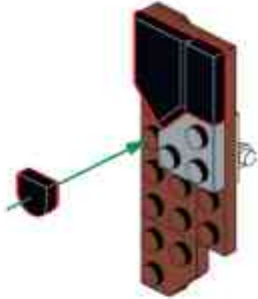

**G138**

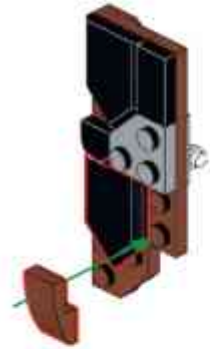

**G139**

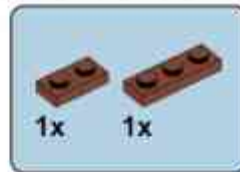
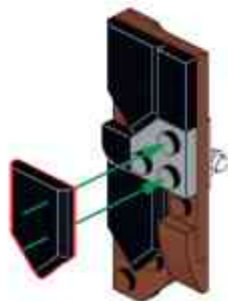

**G140**

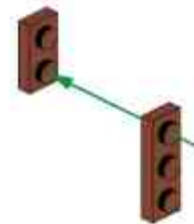



**G141**

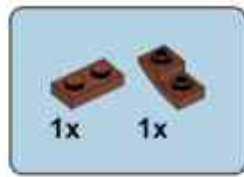
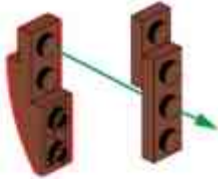

**G142**

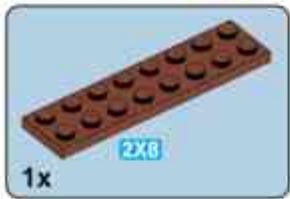

**G143**

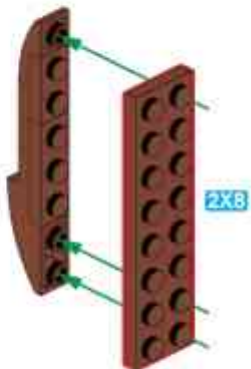

**G144**

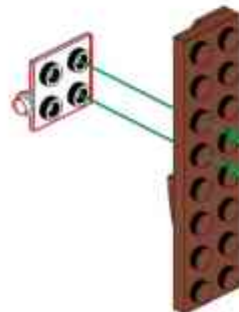

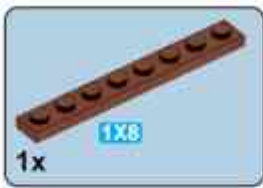

**G145**

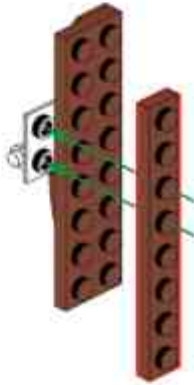

**G146**

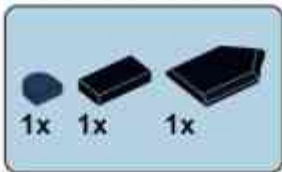
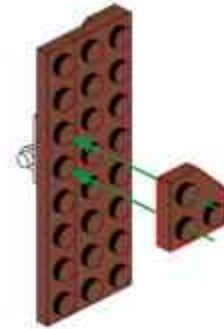

**G147**

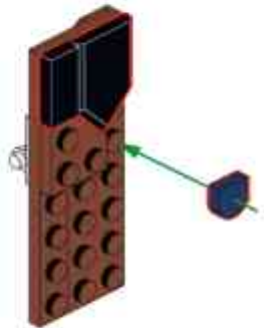

**G148**

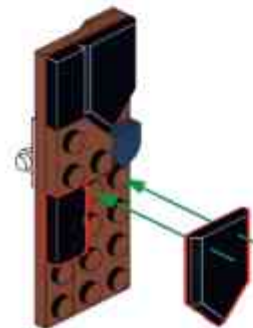

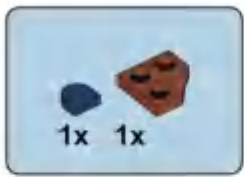

**G149**

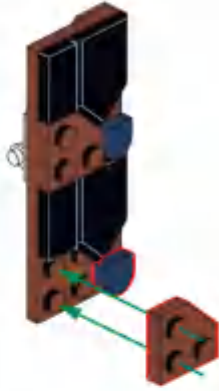

**G150**

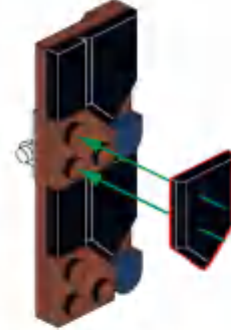

**G151**





**G152**

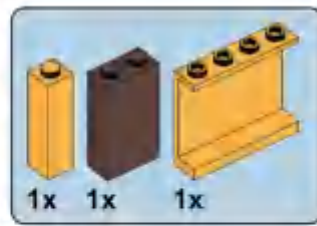

**G153**

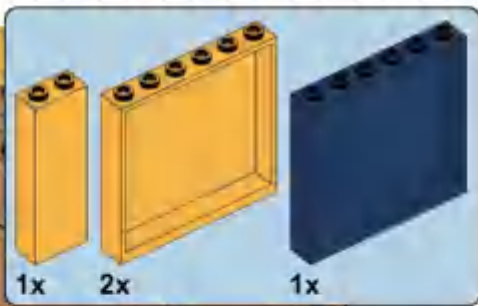

**G154**

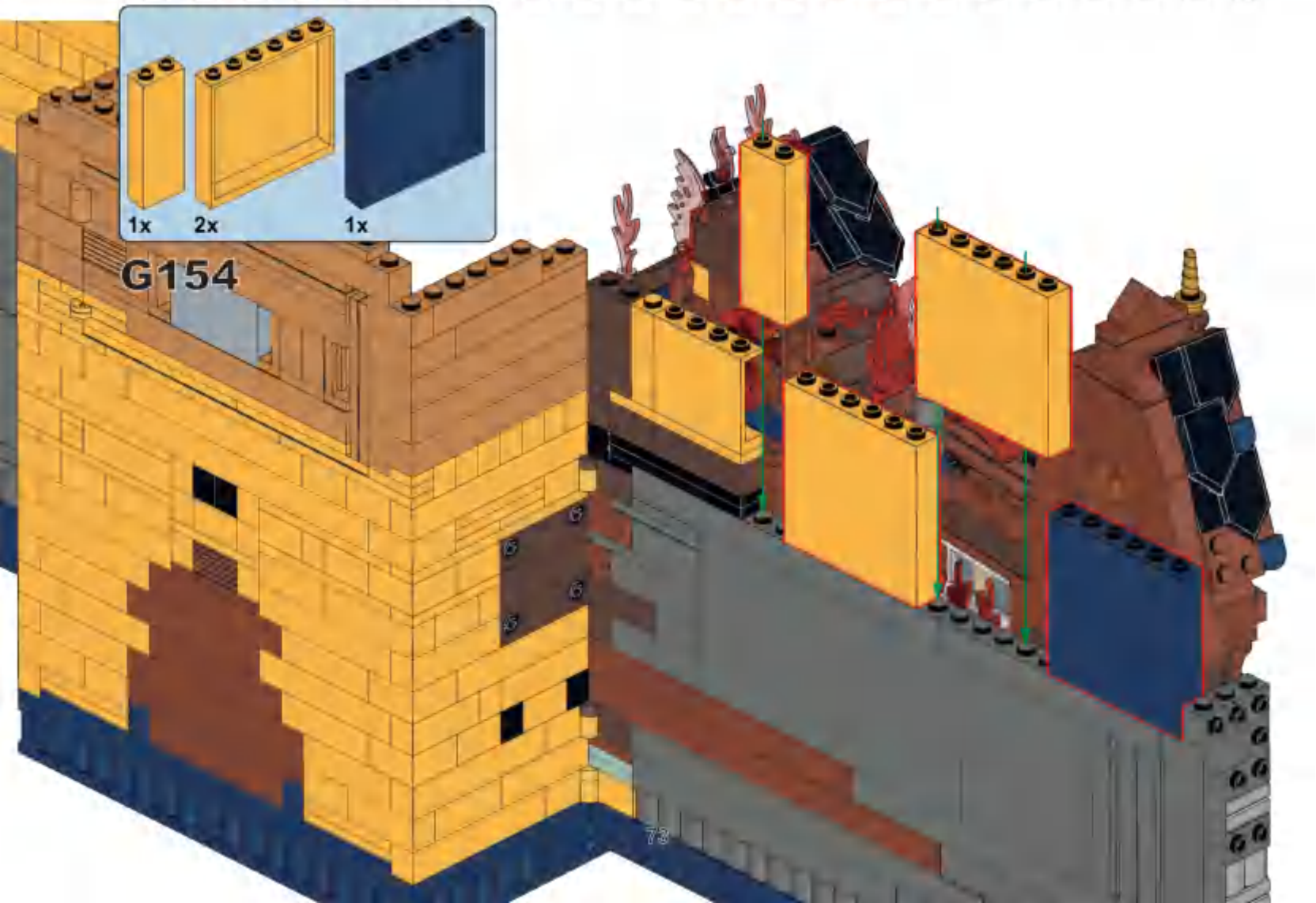

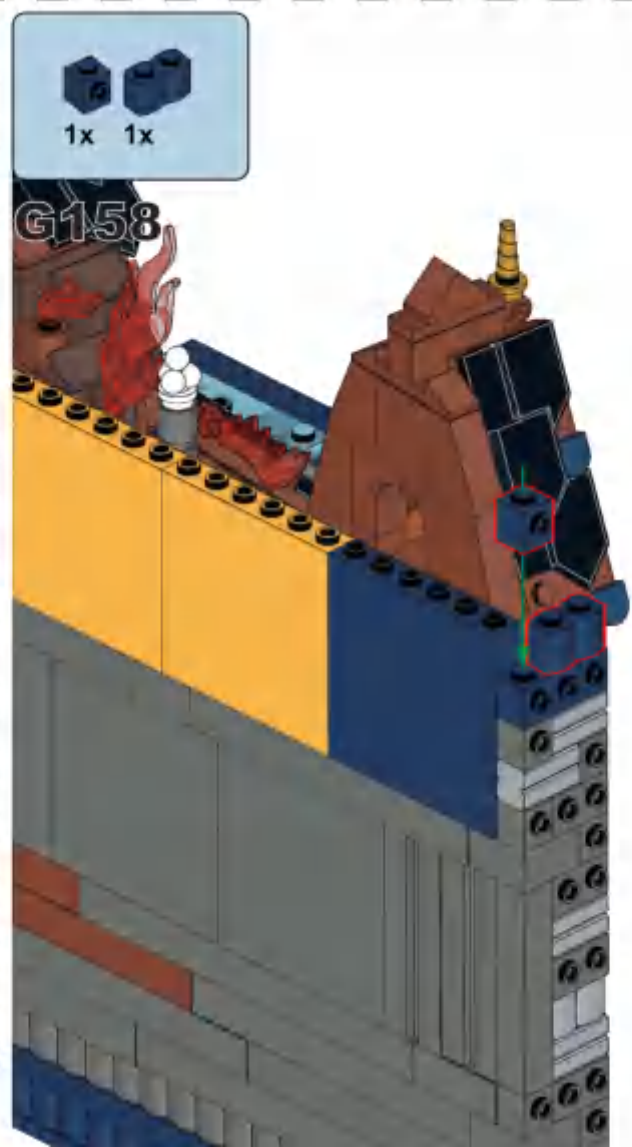
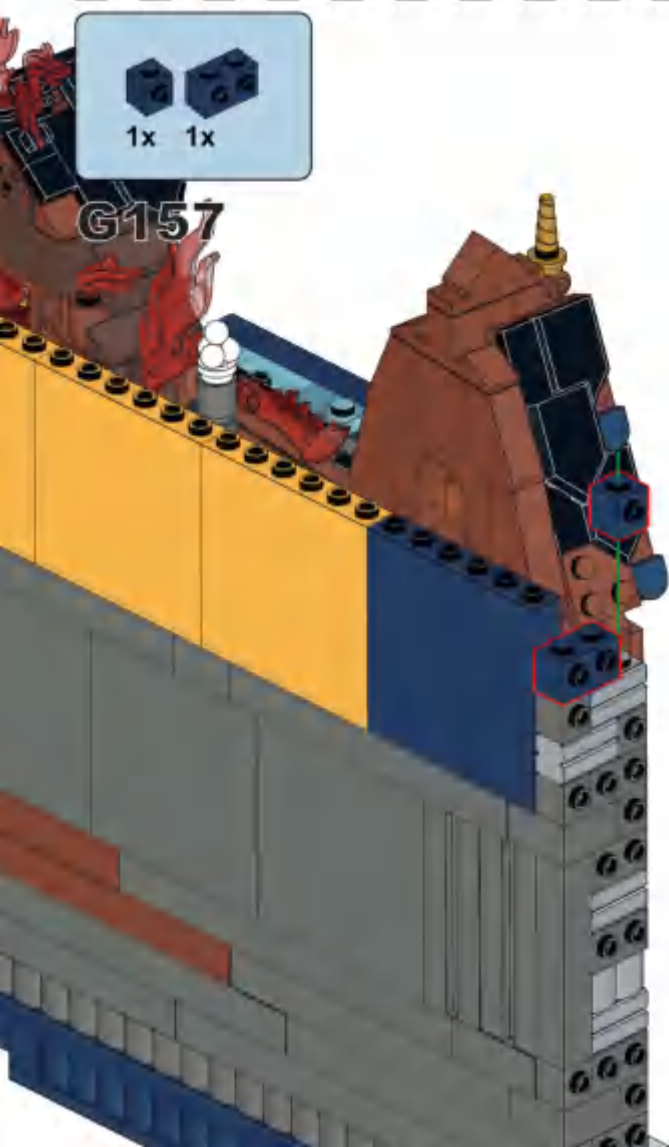
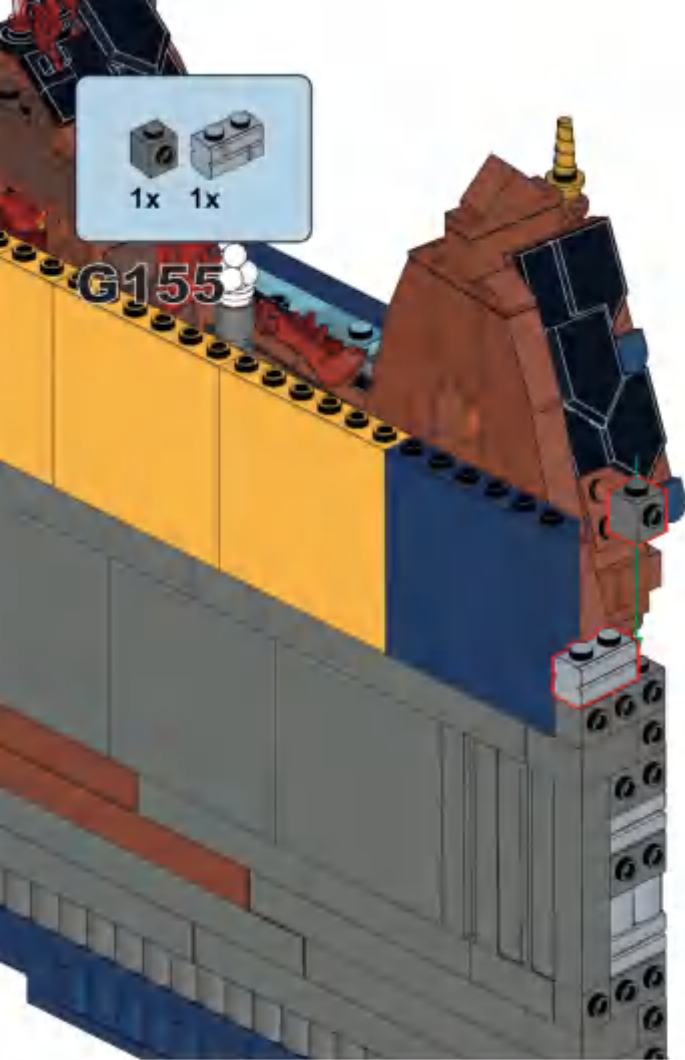

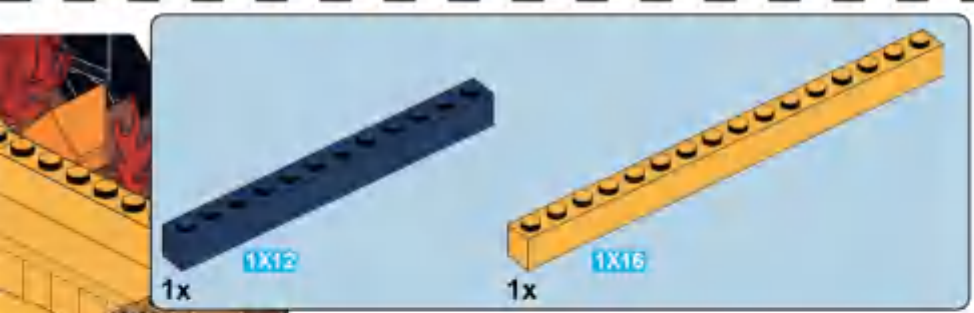



**G161**

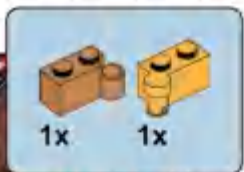

**G162**

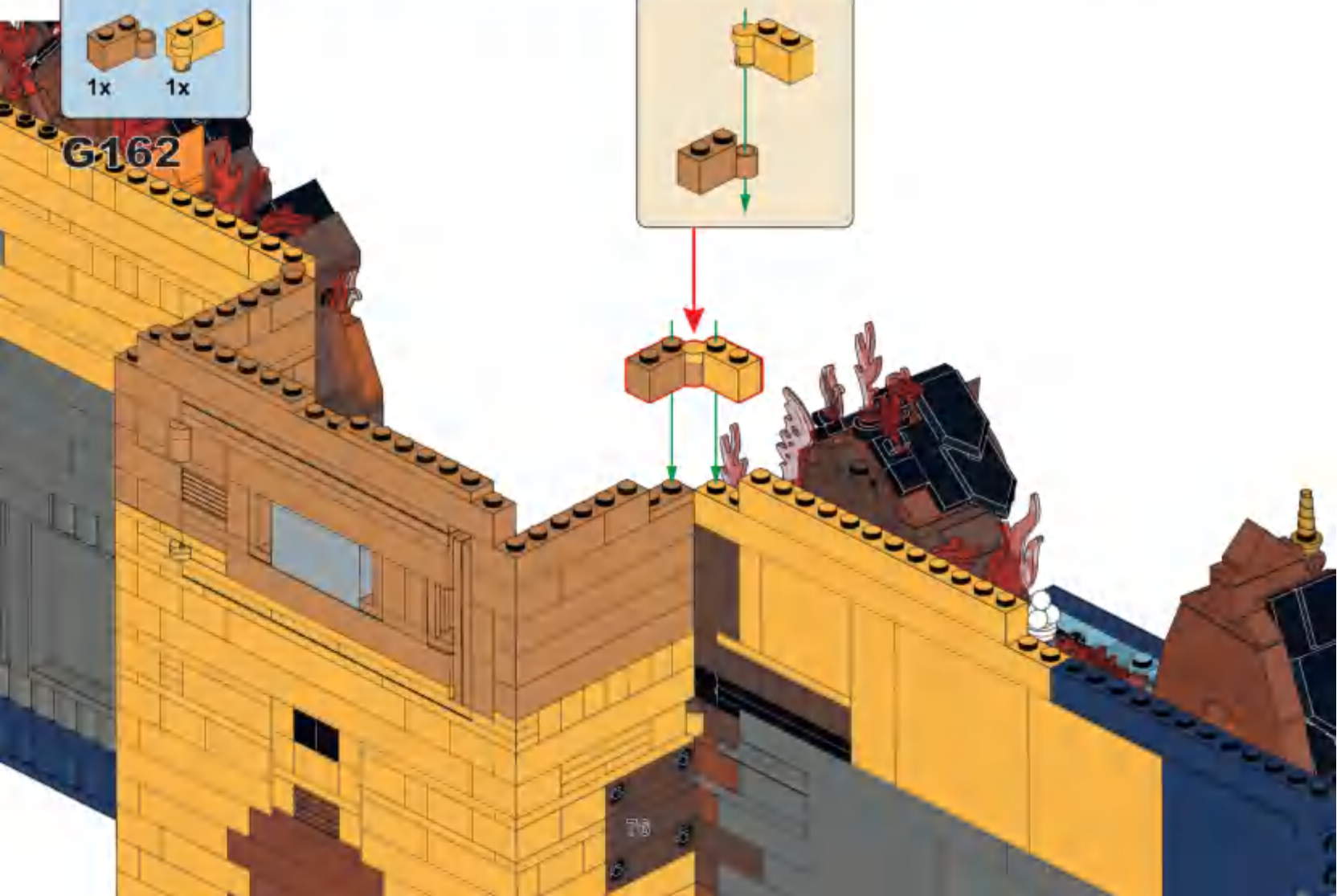
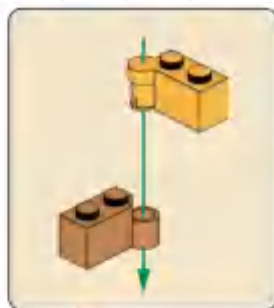

8

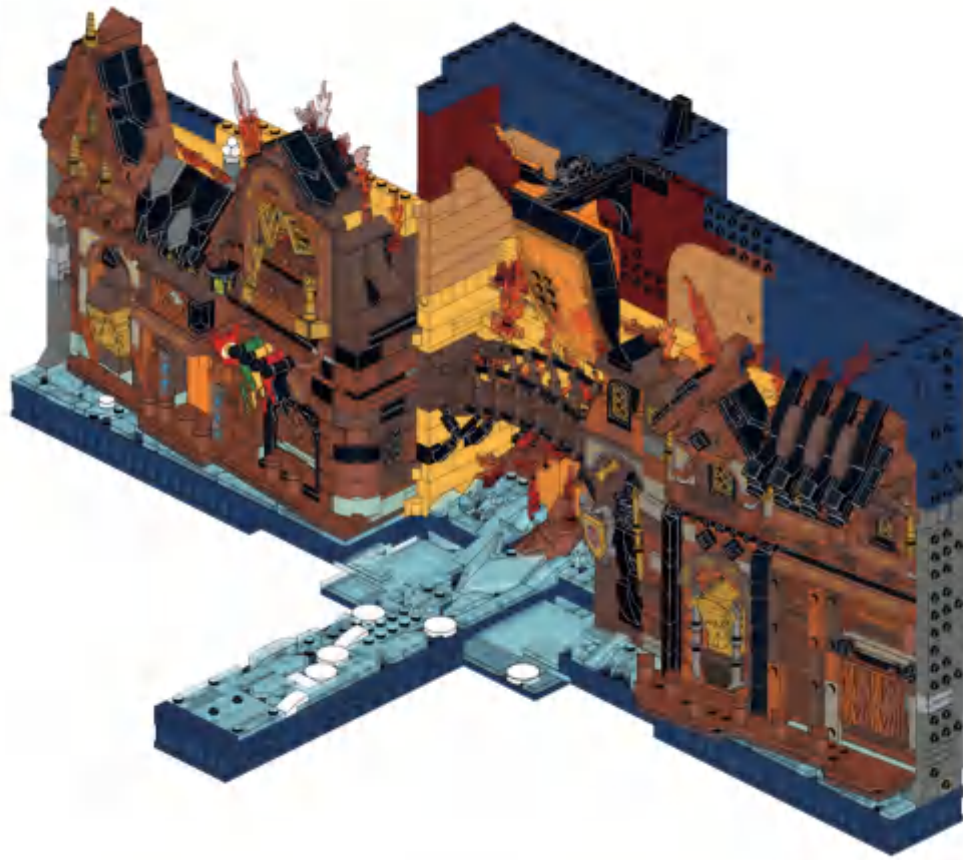

H

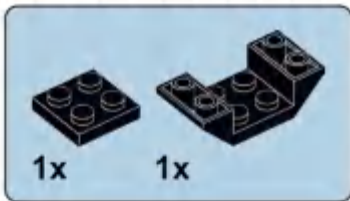

H1

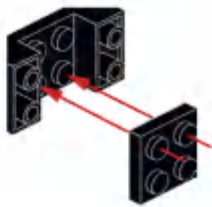

H2

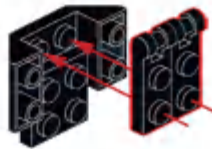

H3

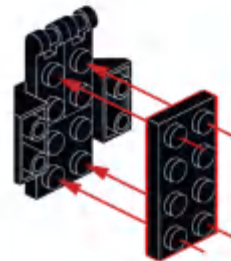

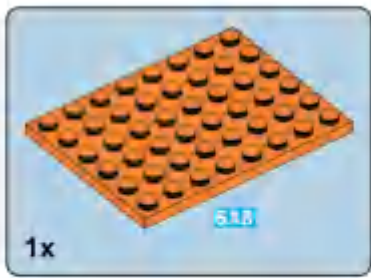

H4

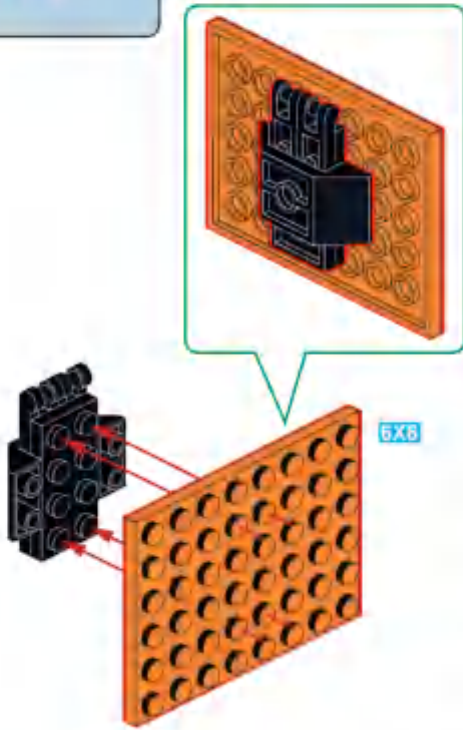

H5

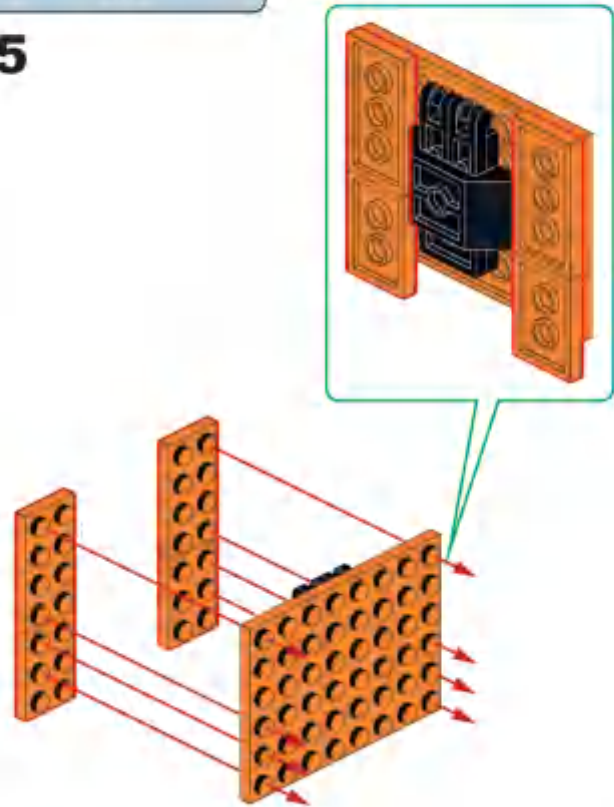

H6

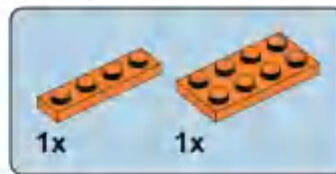
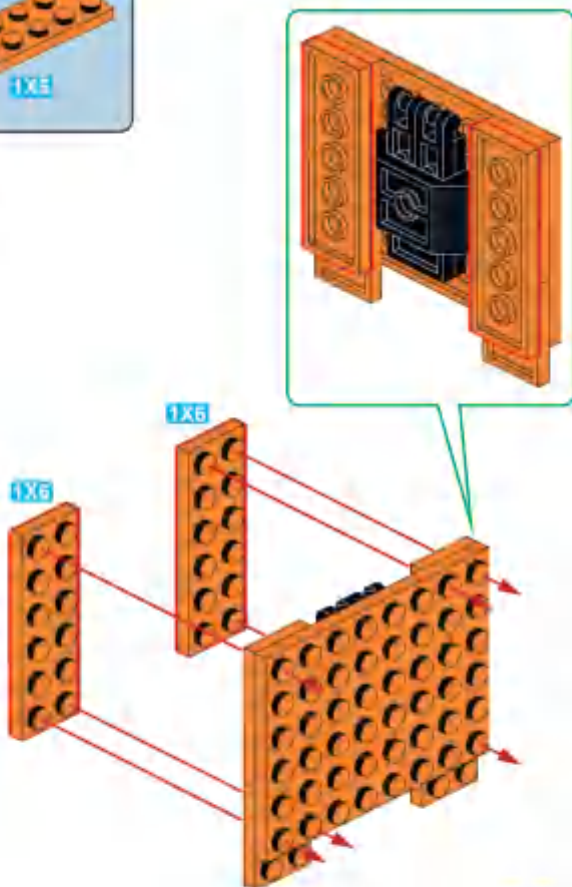

H7

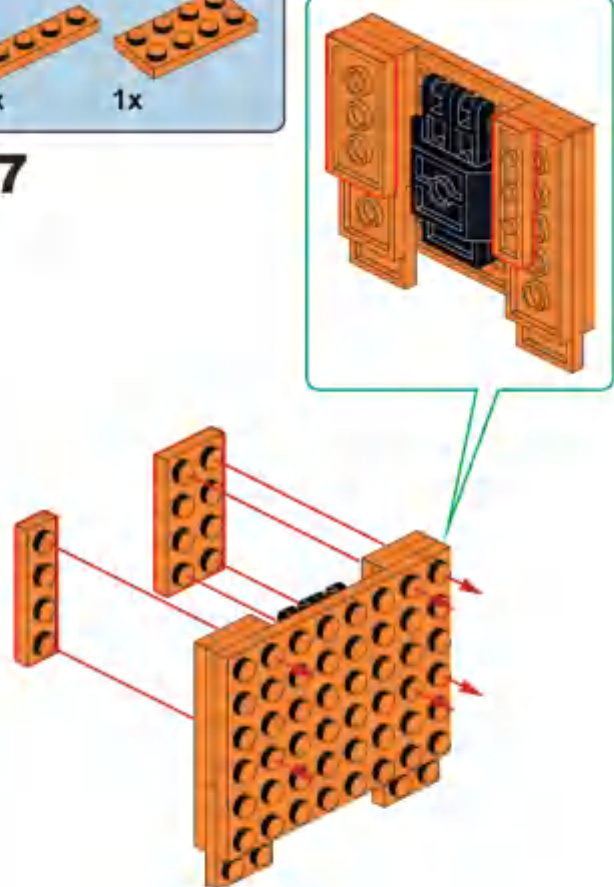

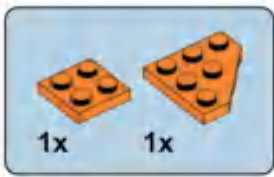

**H8**

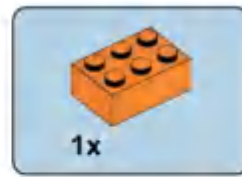
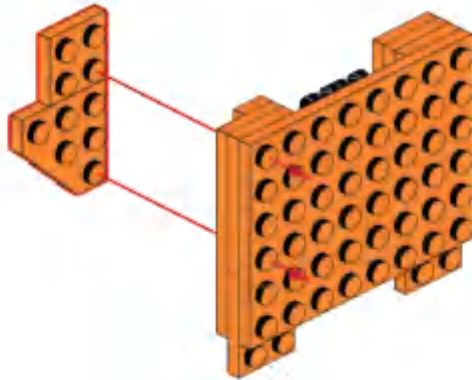

**H9**

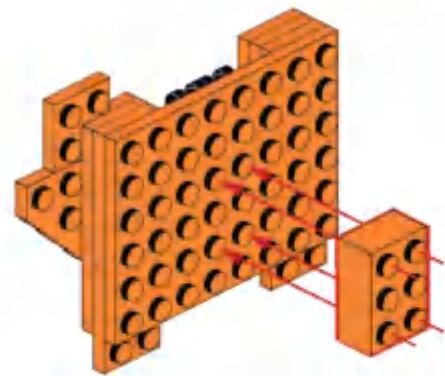

**H10**

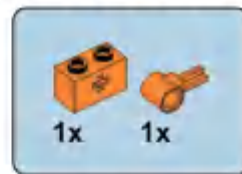
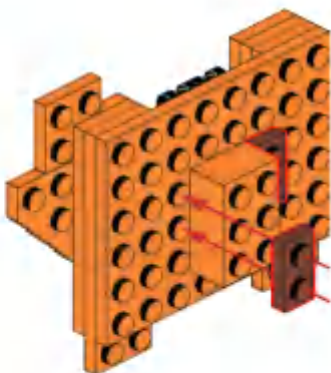
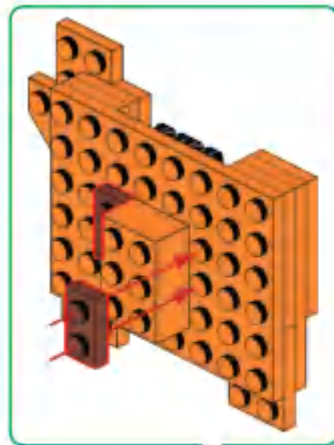

**H11**

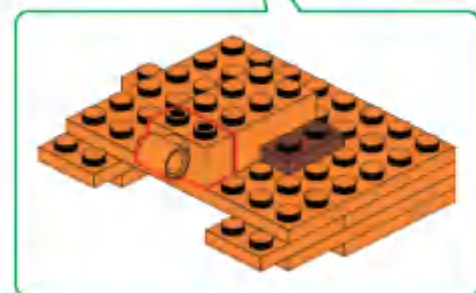
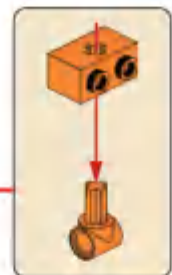
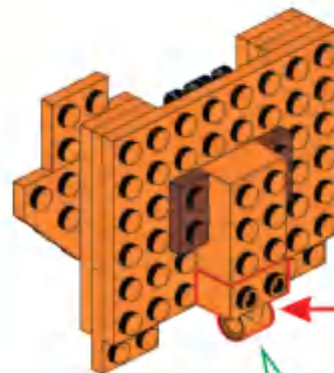

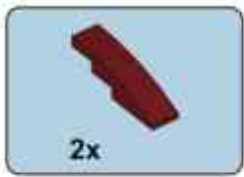

**H12**

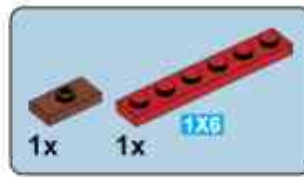
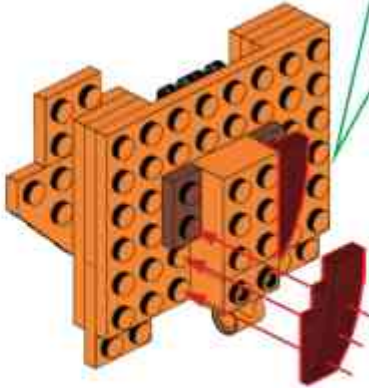
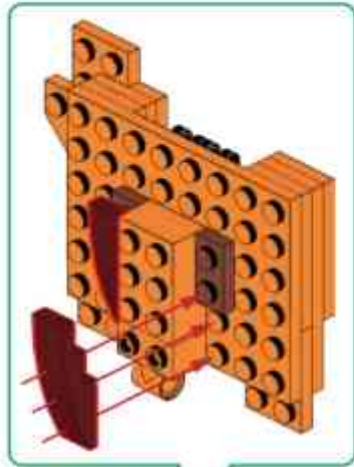

**H13**

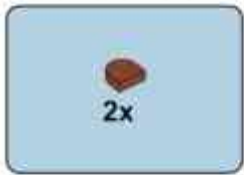
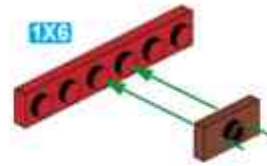

**H14**

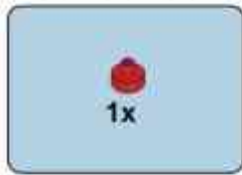
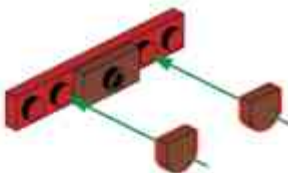

**H15**

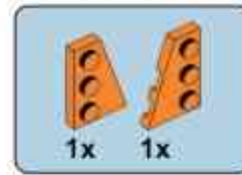

**H16**

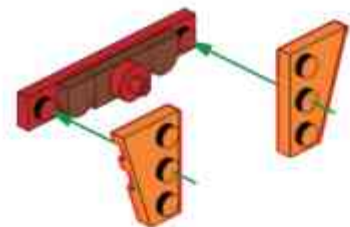



**H17**

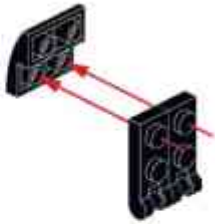

**H18**

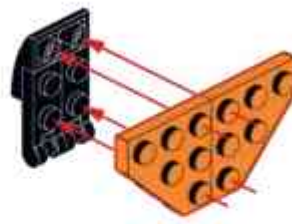

**H19**

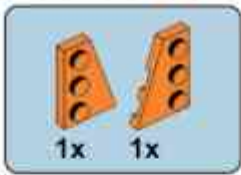
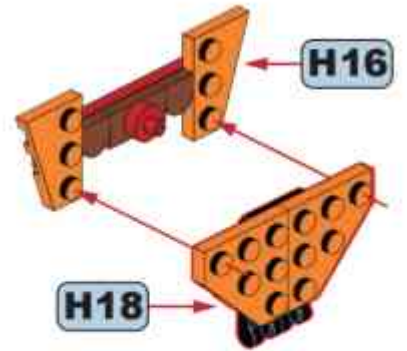

**H20**

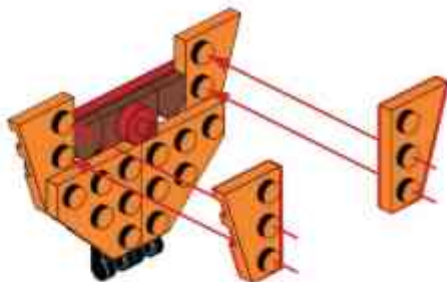

**H21**

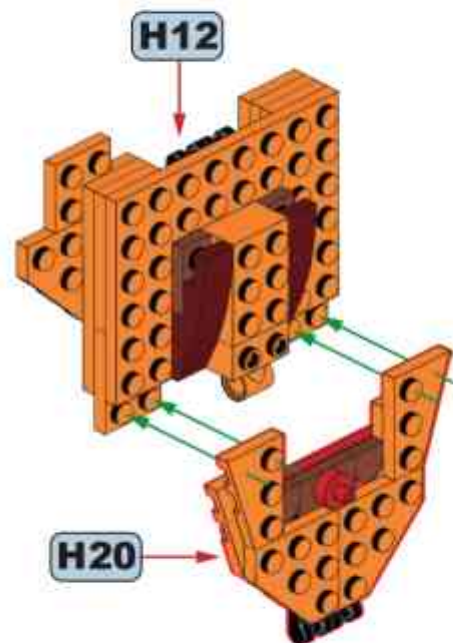



## H22

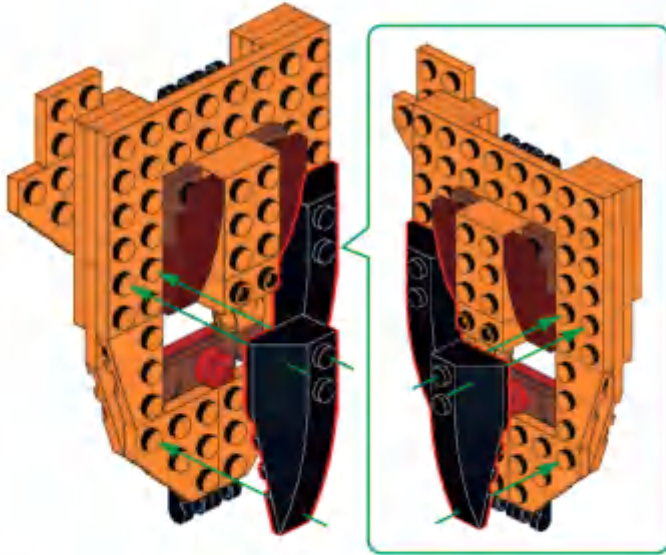

## H23

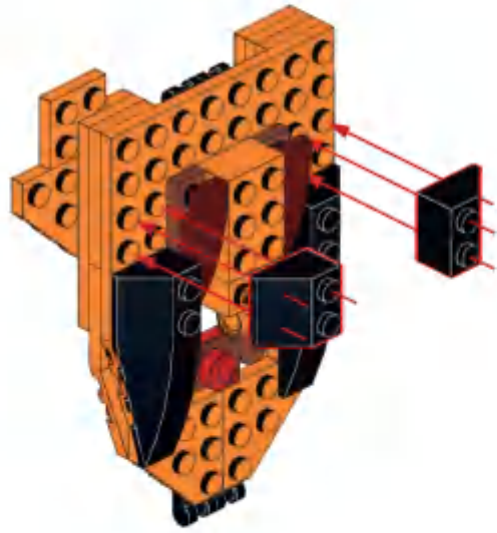

## H24

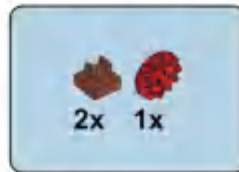
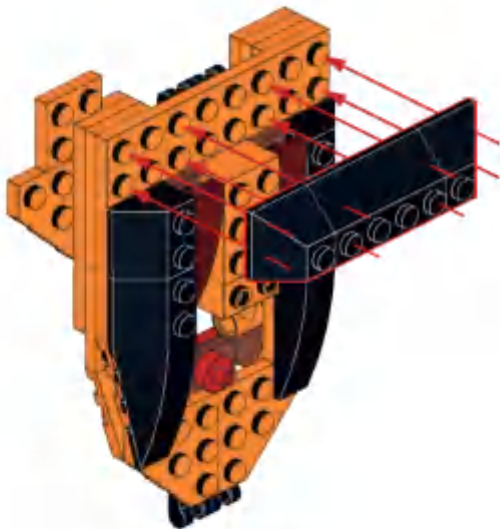

## H25

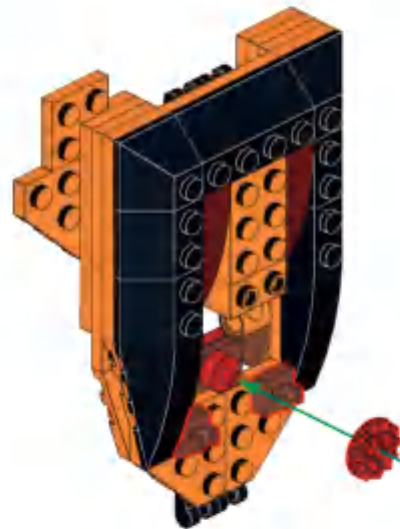

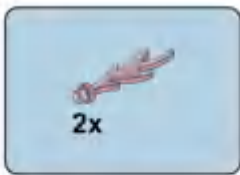

**H26**

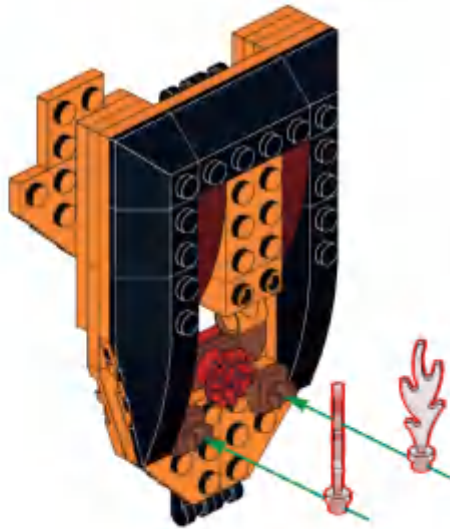

**H27**

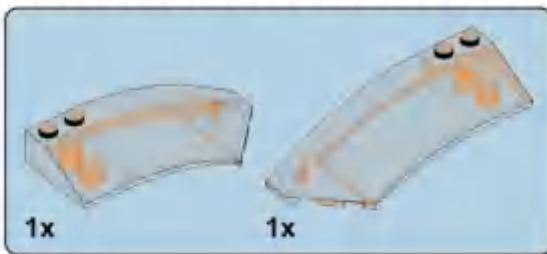
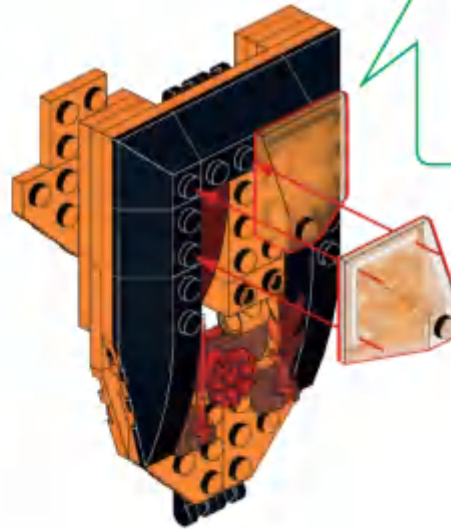

**H28**

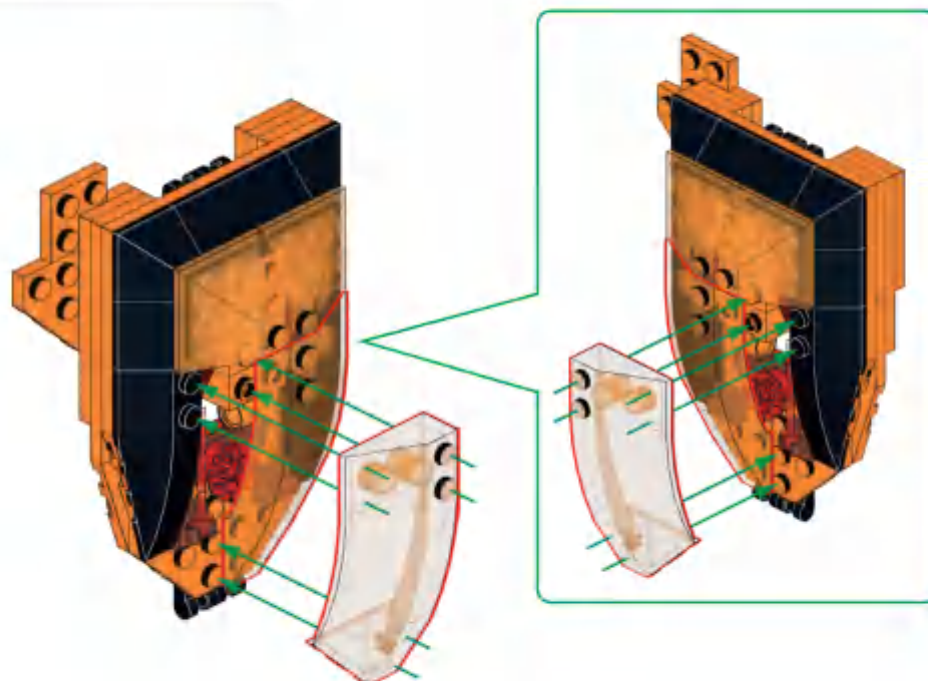



**H29**

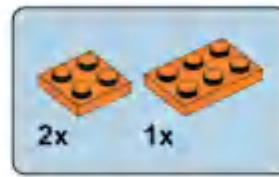
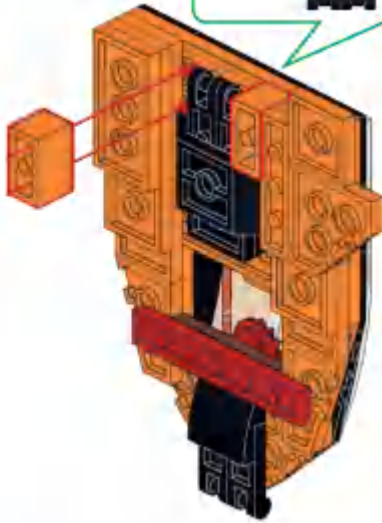
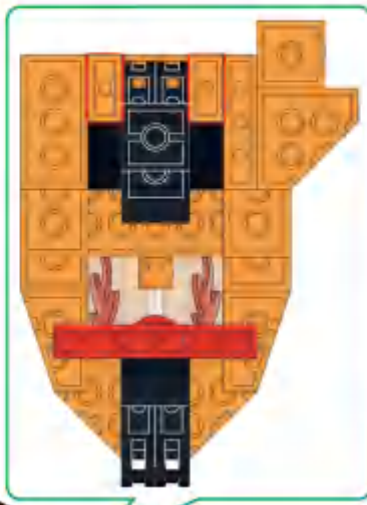

**H30**

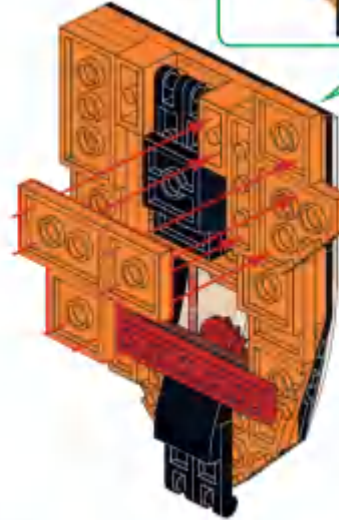
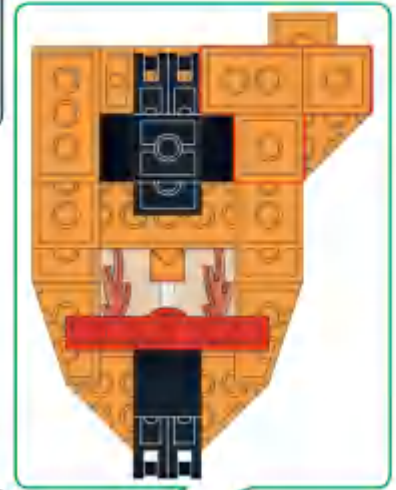

**H31**

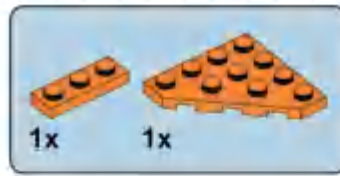
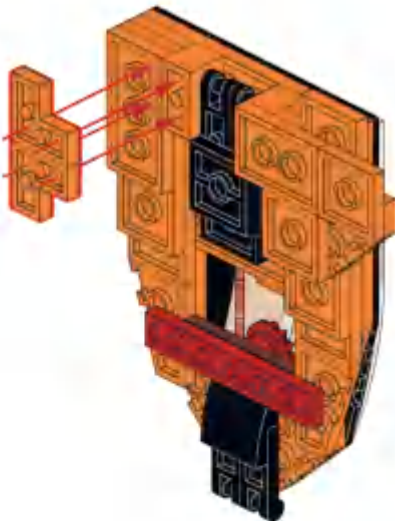

**H32**

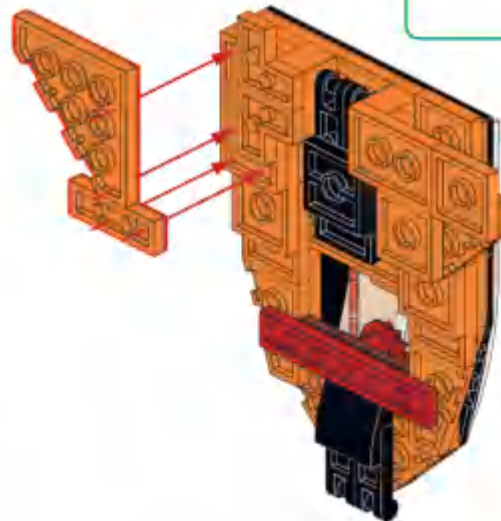
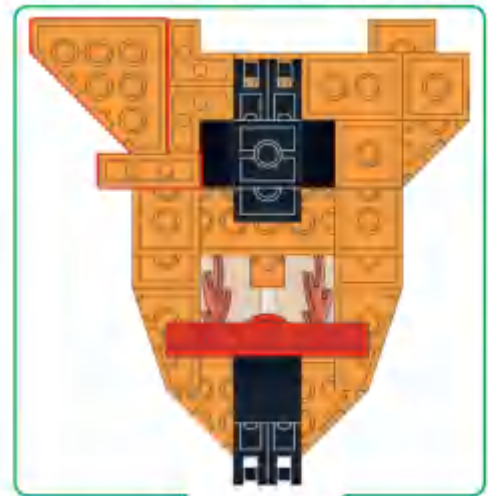



1x

**H33**

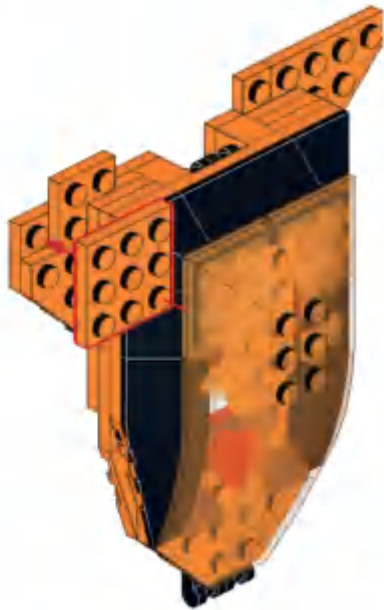

1x

**H34**

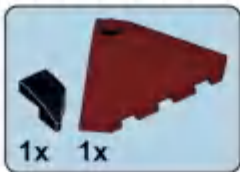
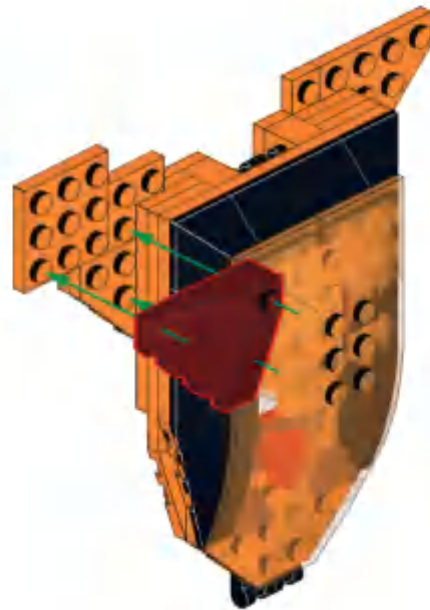

1x 1x

**H35**

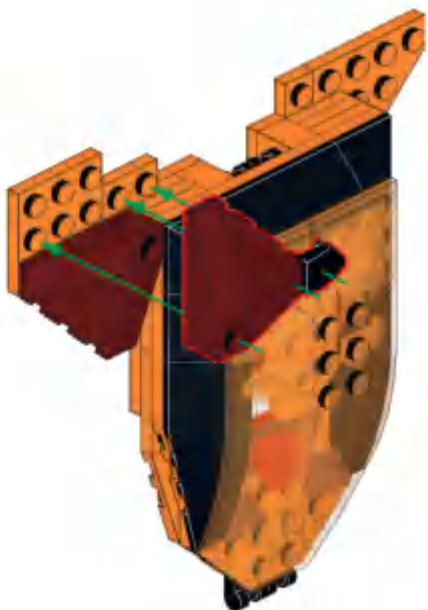

2x

**H36**

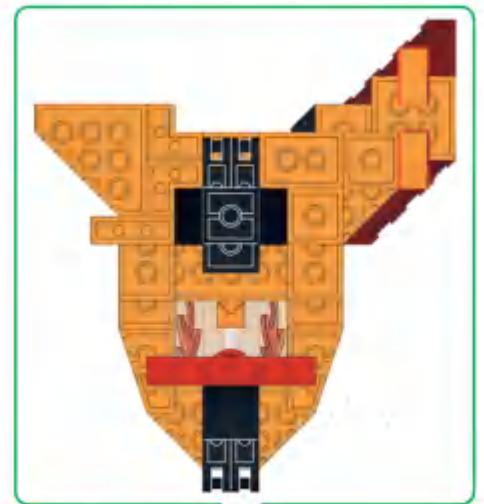



**H37**

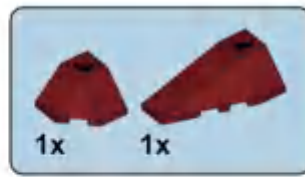
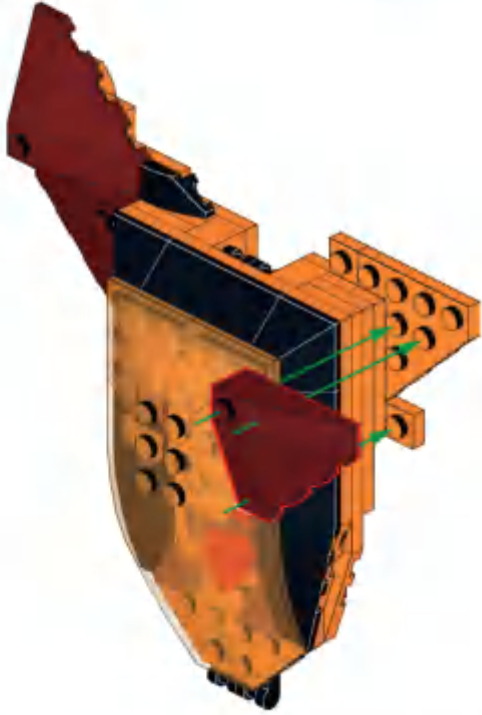

**H38**

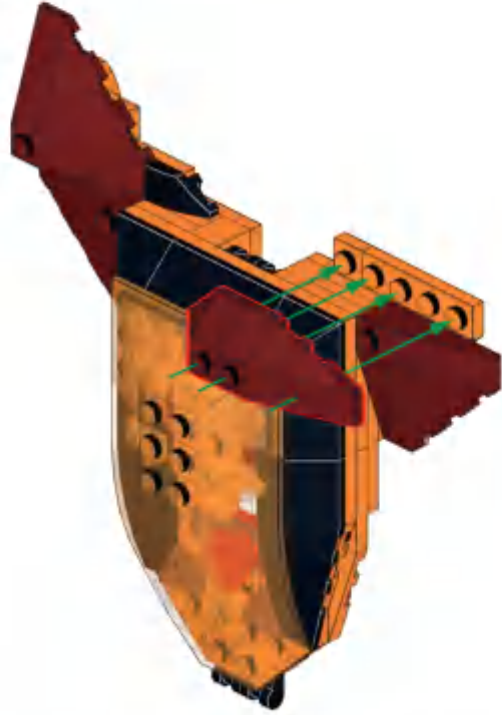

**H39**



**H40**

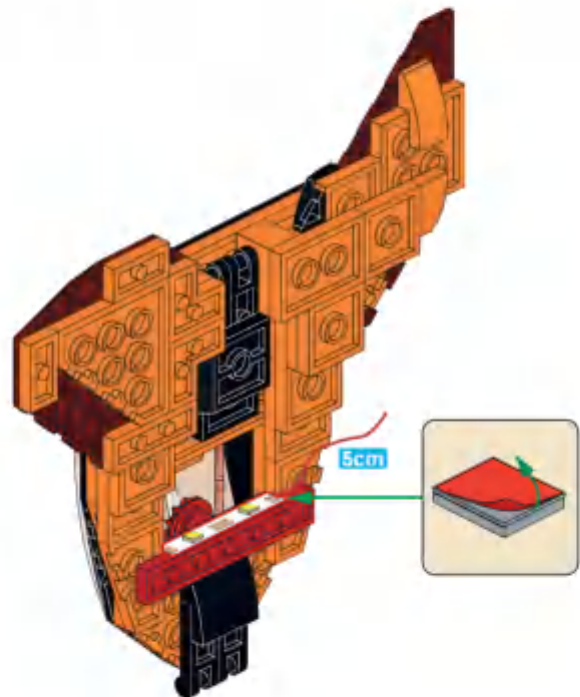



**H41**

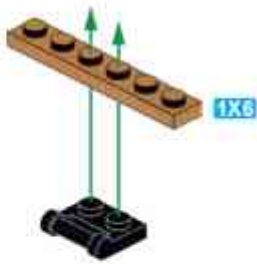

**H42**



**H43**



**H44**

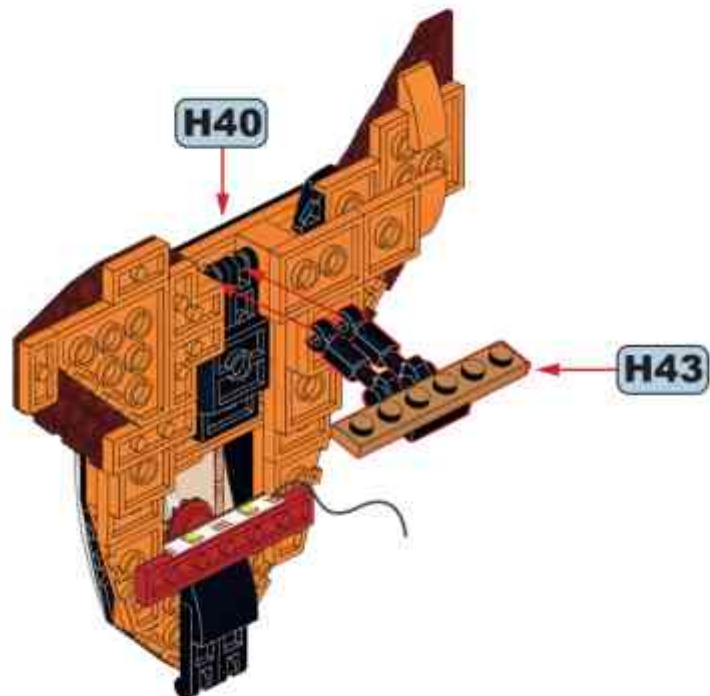

H45



H44

G162

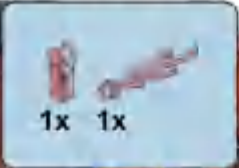

H46





**H47**

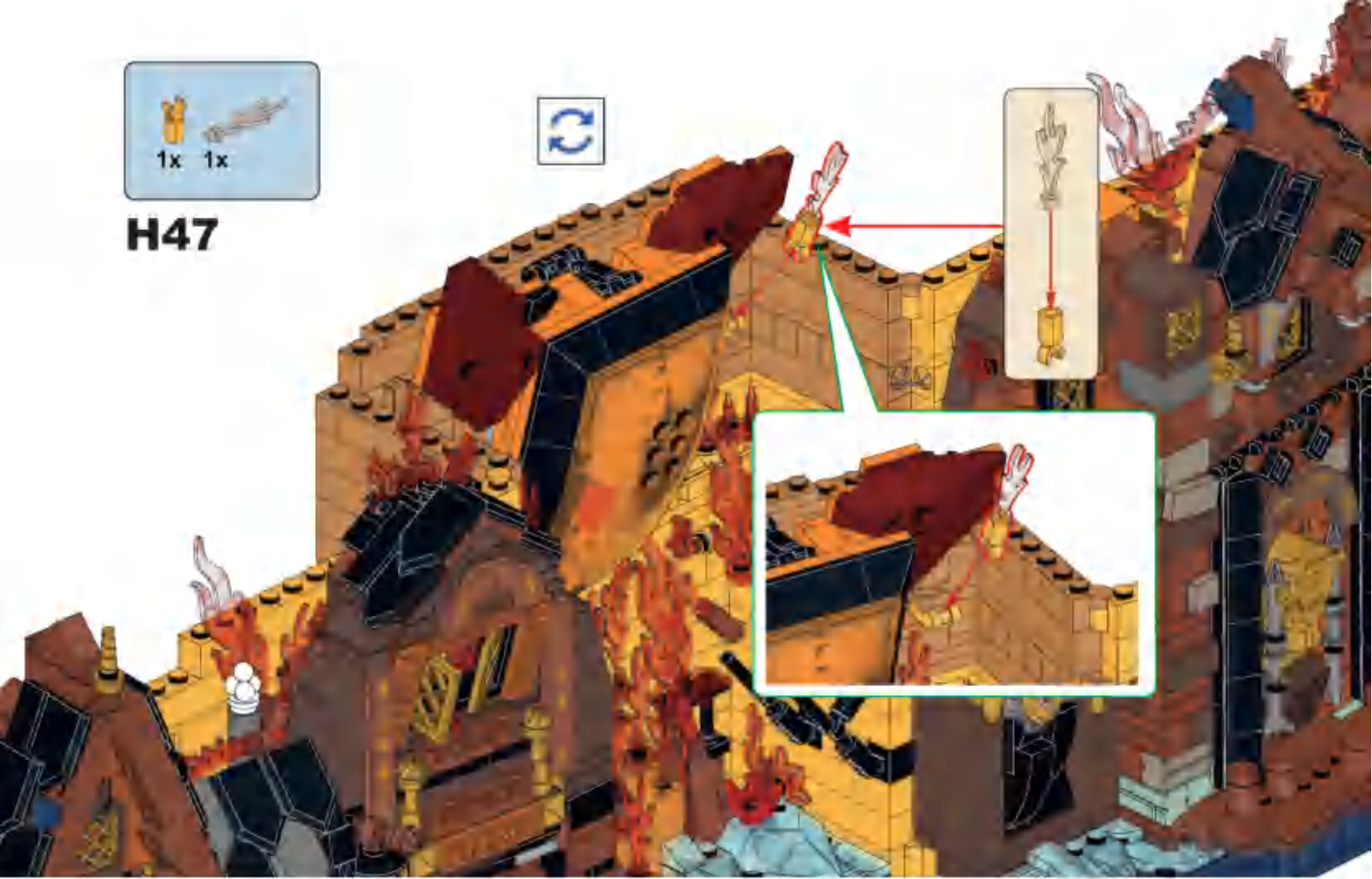

**H48**

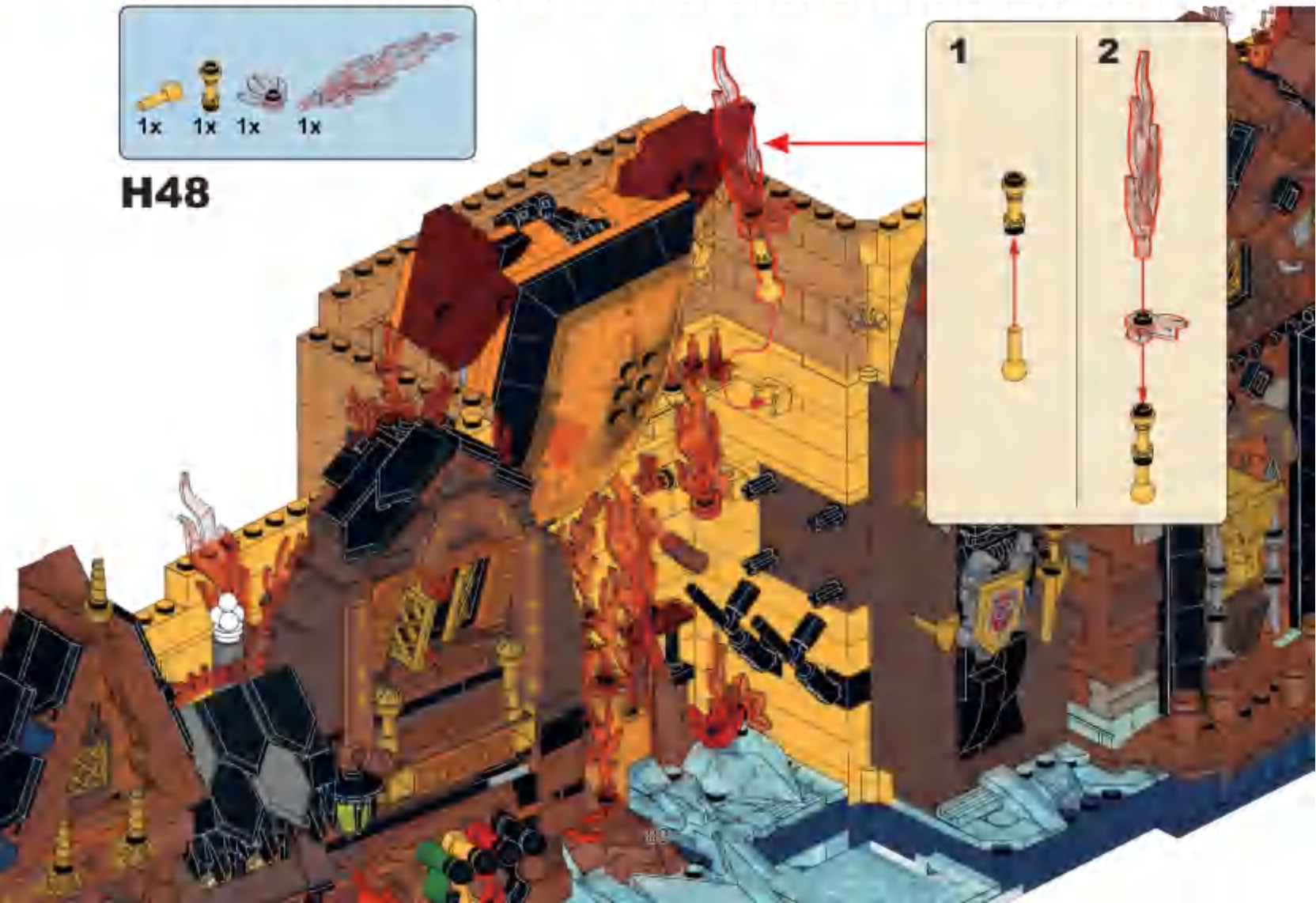



**H49**



**H50**

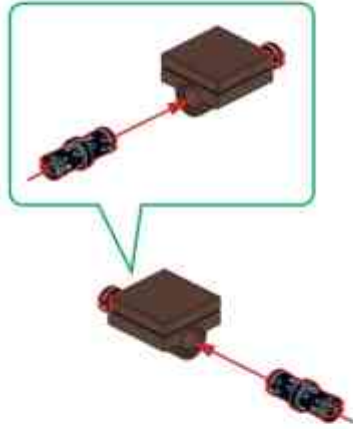

**H51**



**H52**



**H53**

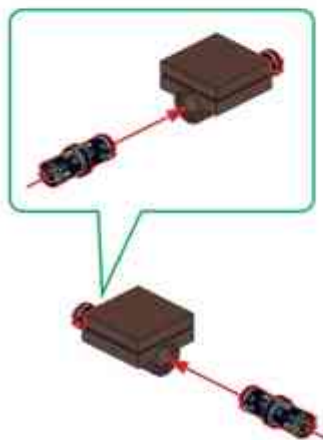

**H54**



**H55**

H48

H54



**H56**





**H57**

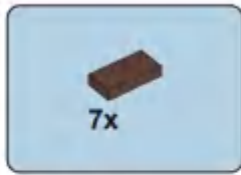

**H58**



**H59**

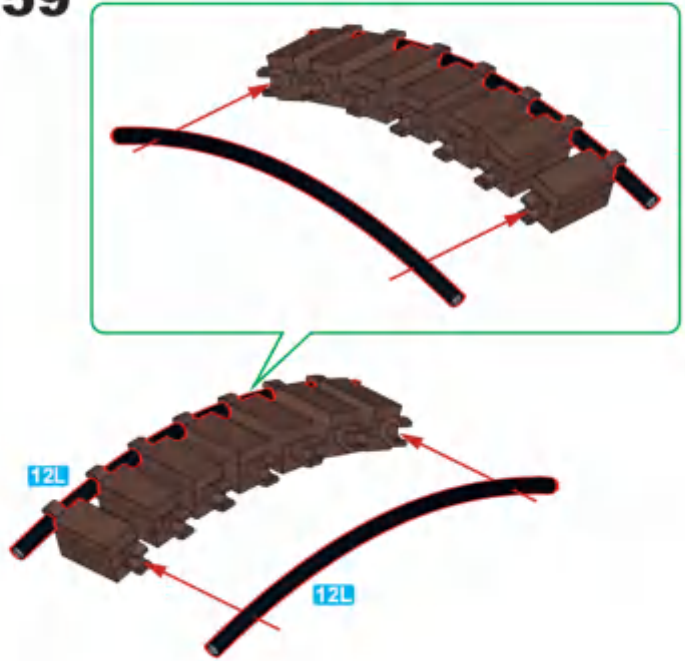

**H60**

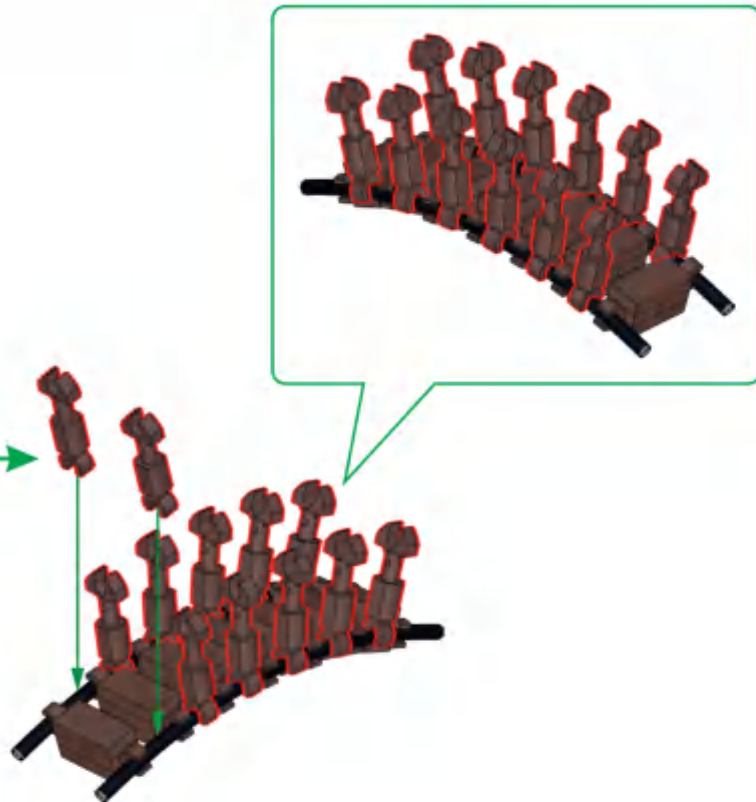
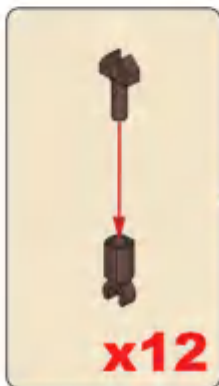



H61

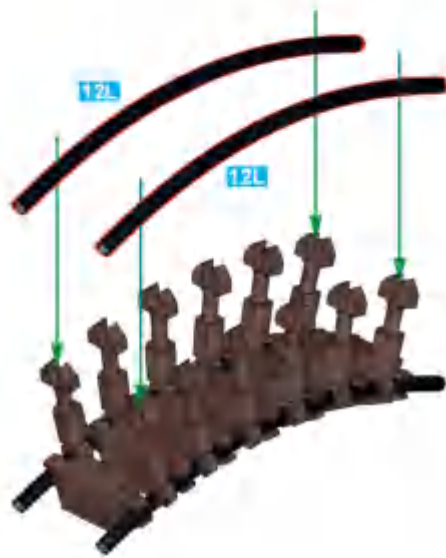

H62

H56

H61

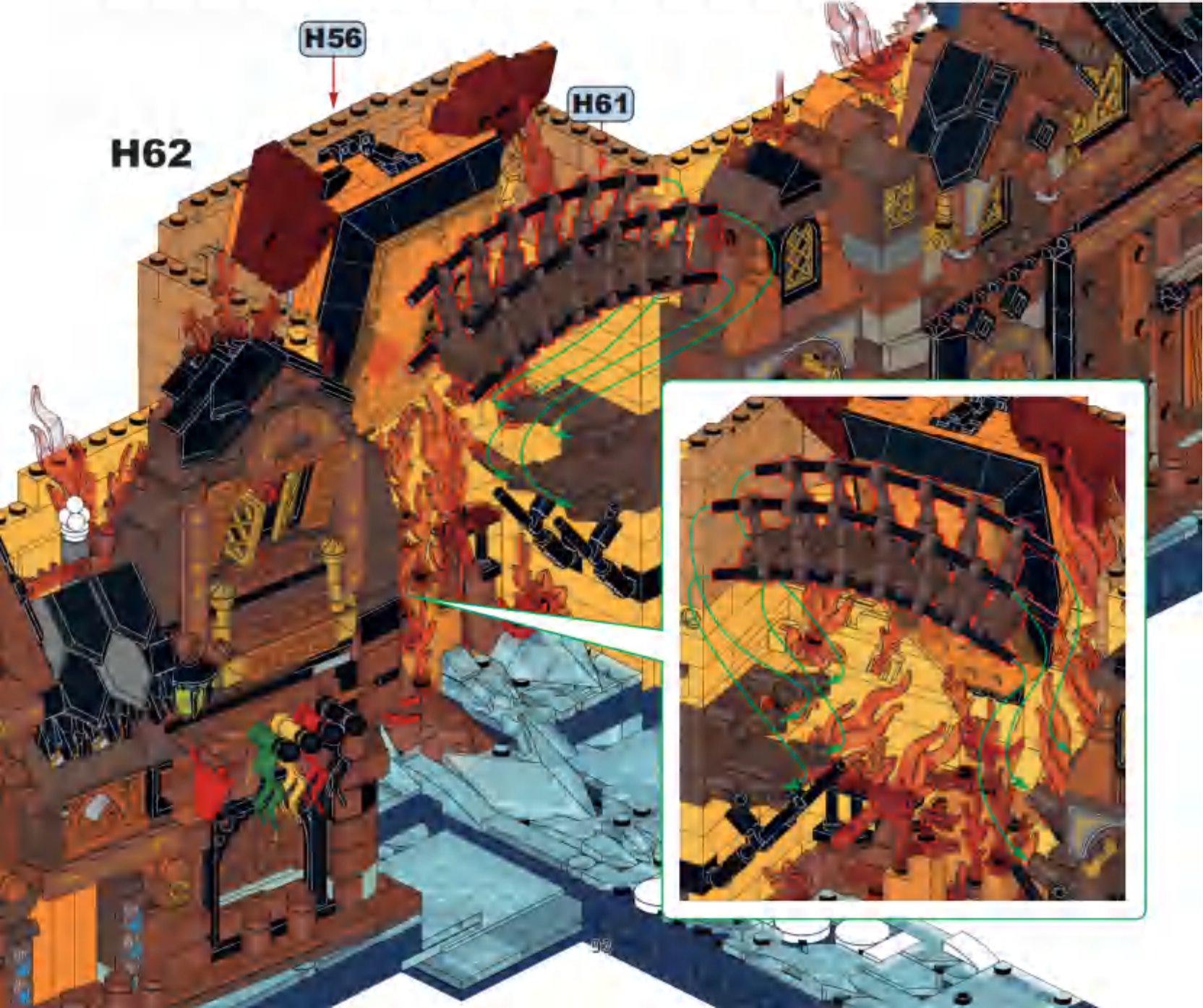



H63



H64

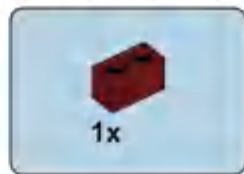
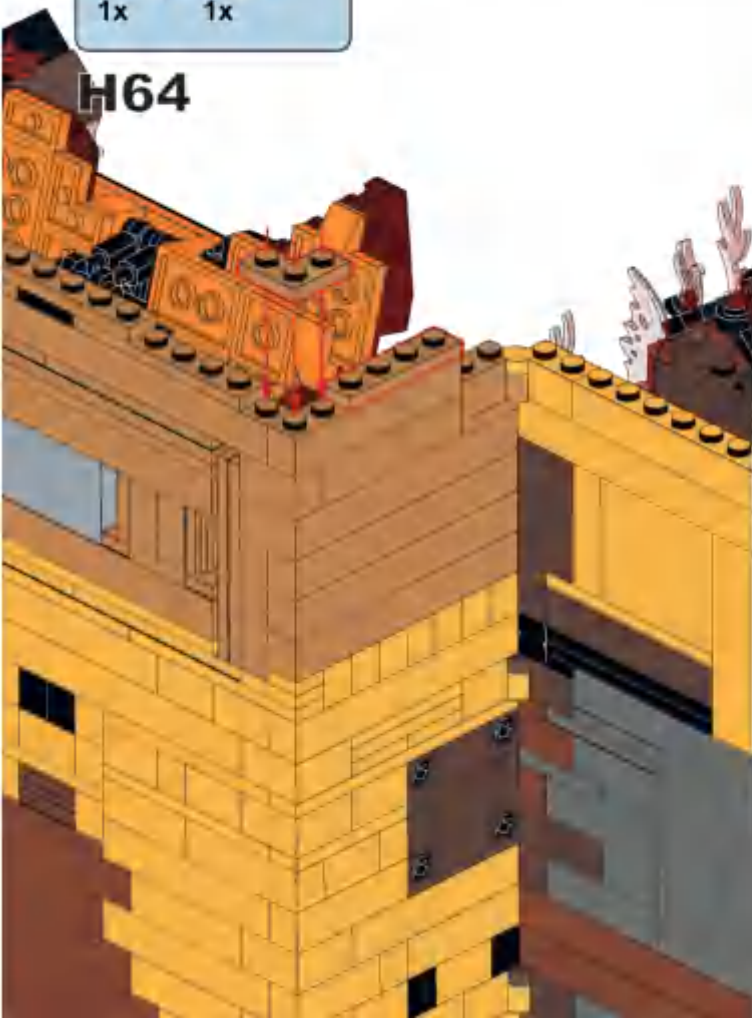

H65





### H66



### H67





## H68

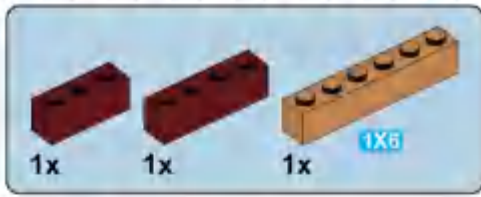
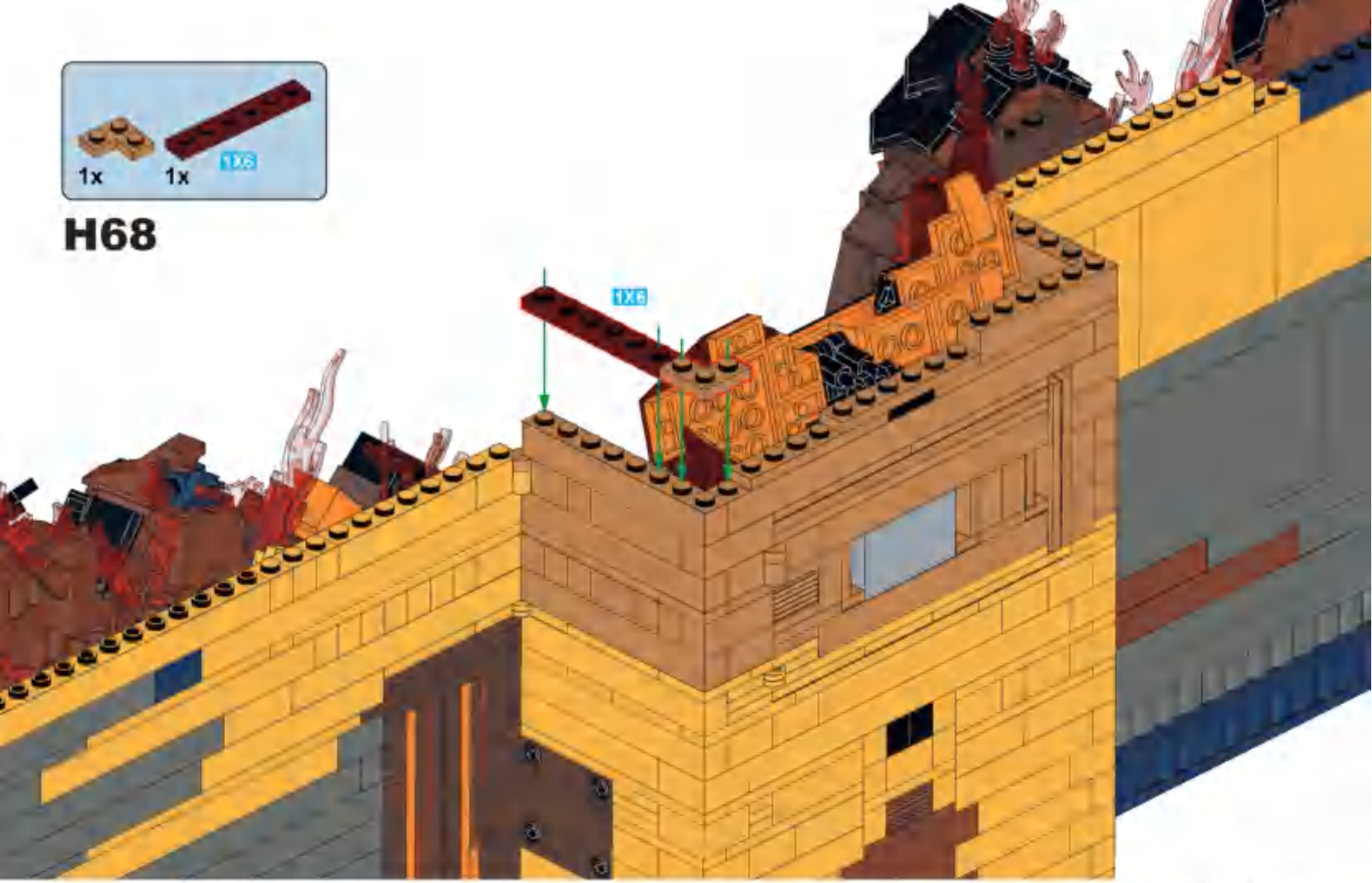

## H69

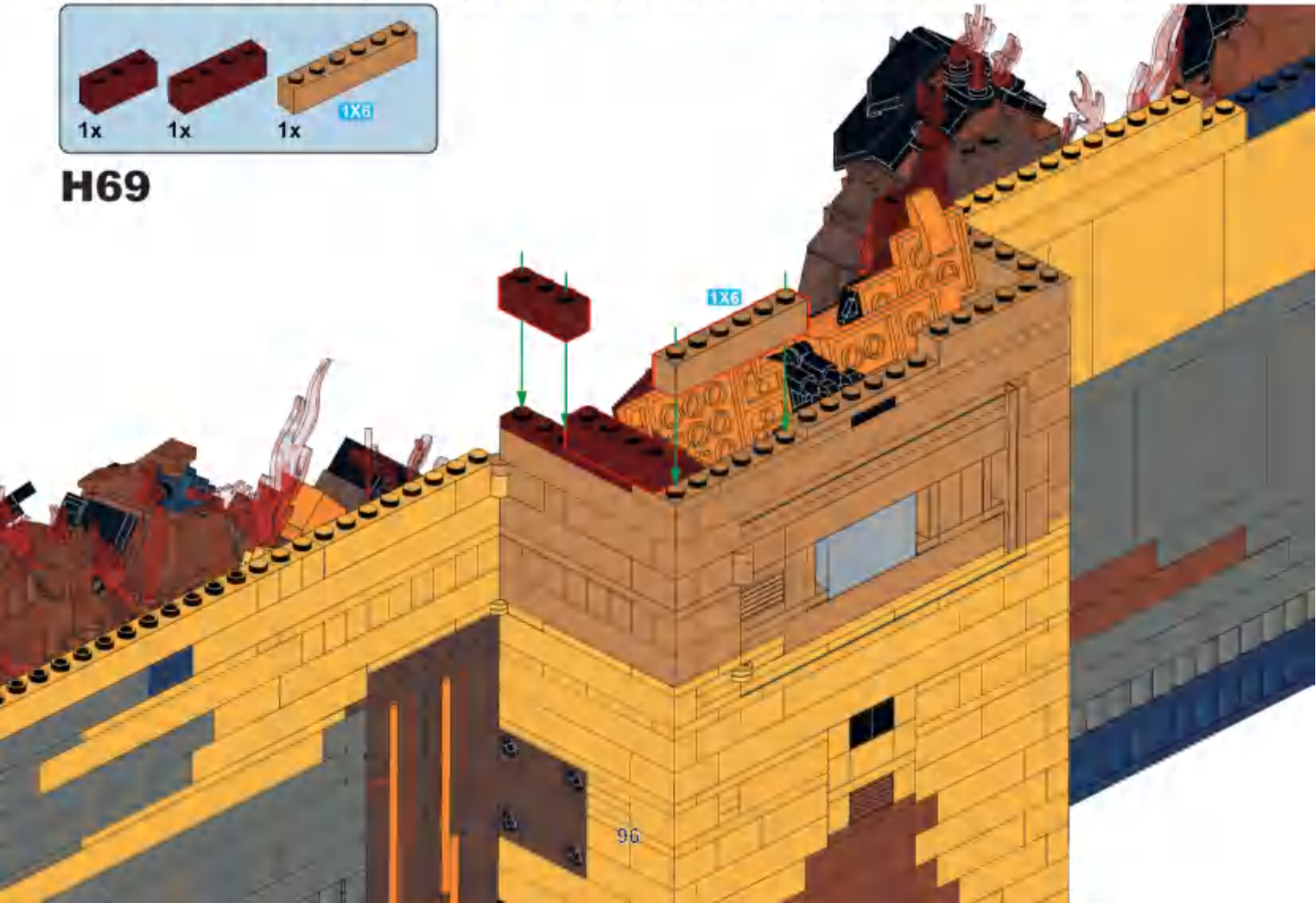

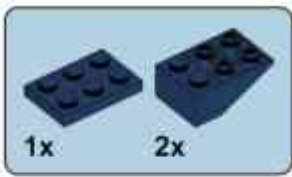

**H70**

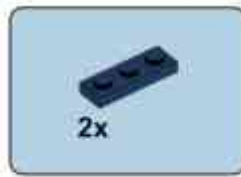

**H71**

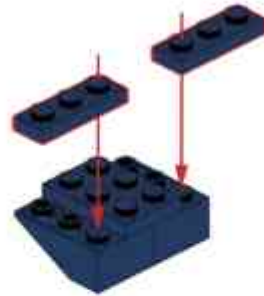

**H72**

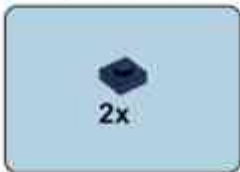
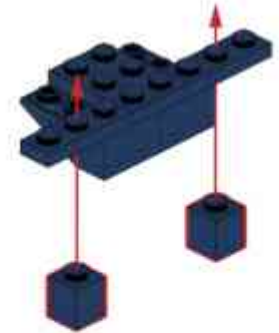

**H73**

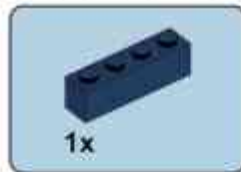
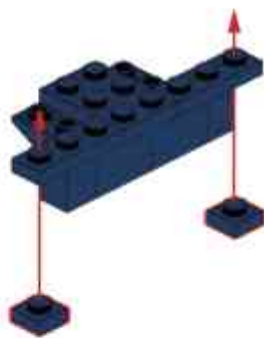

**H74**

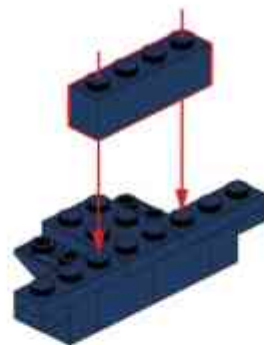

**H75**

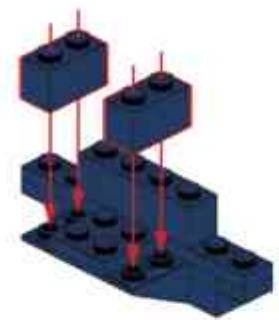



**H76**

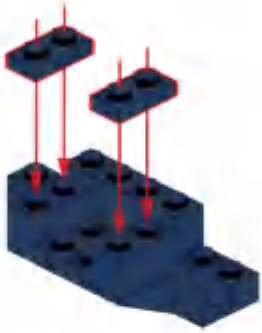

**H77**



**H78**

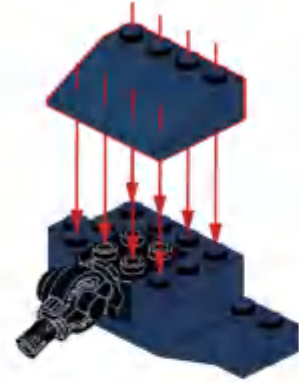

**H79**

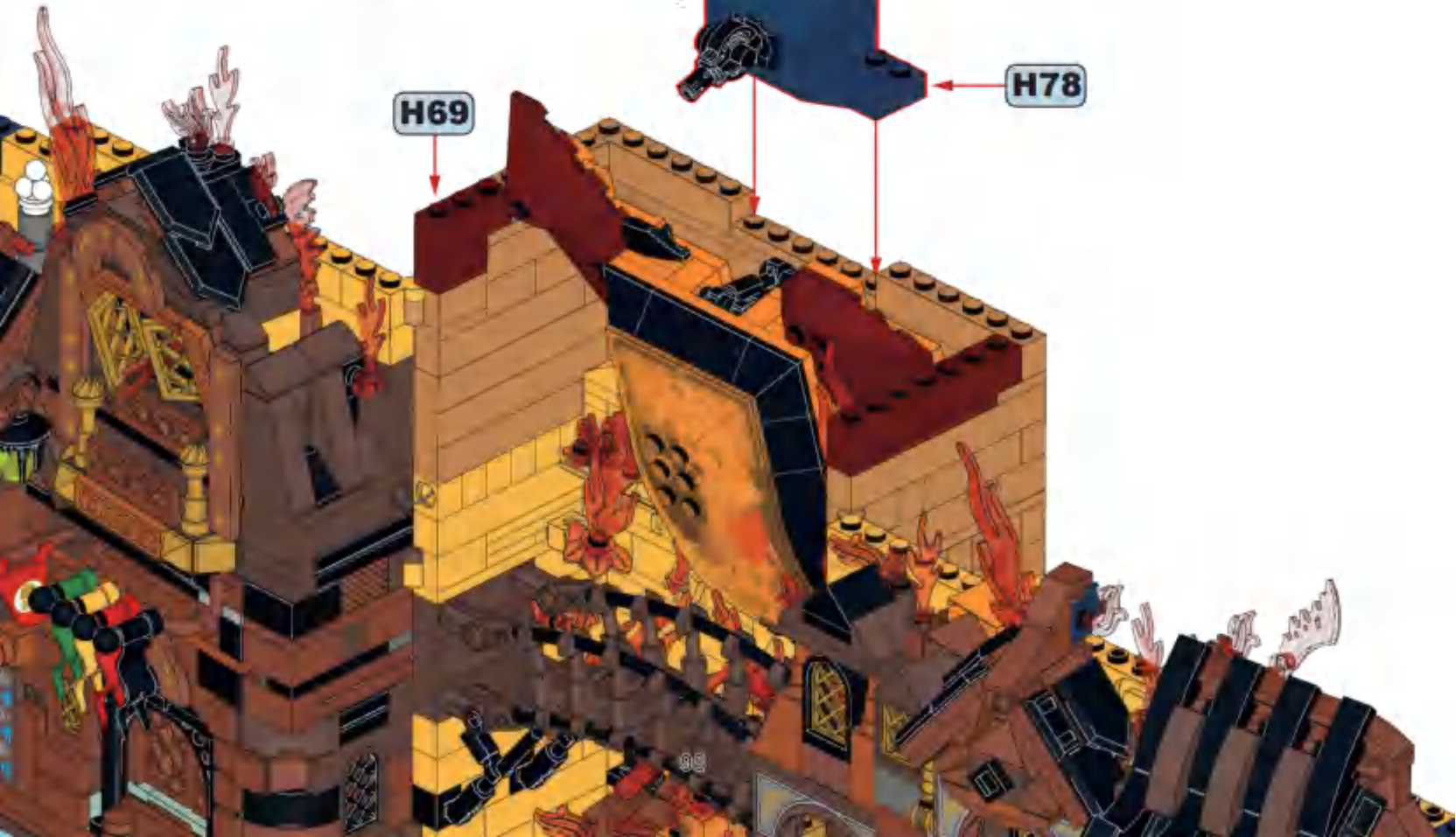



**H80**

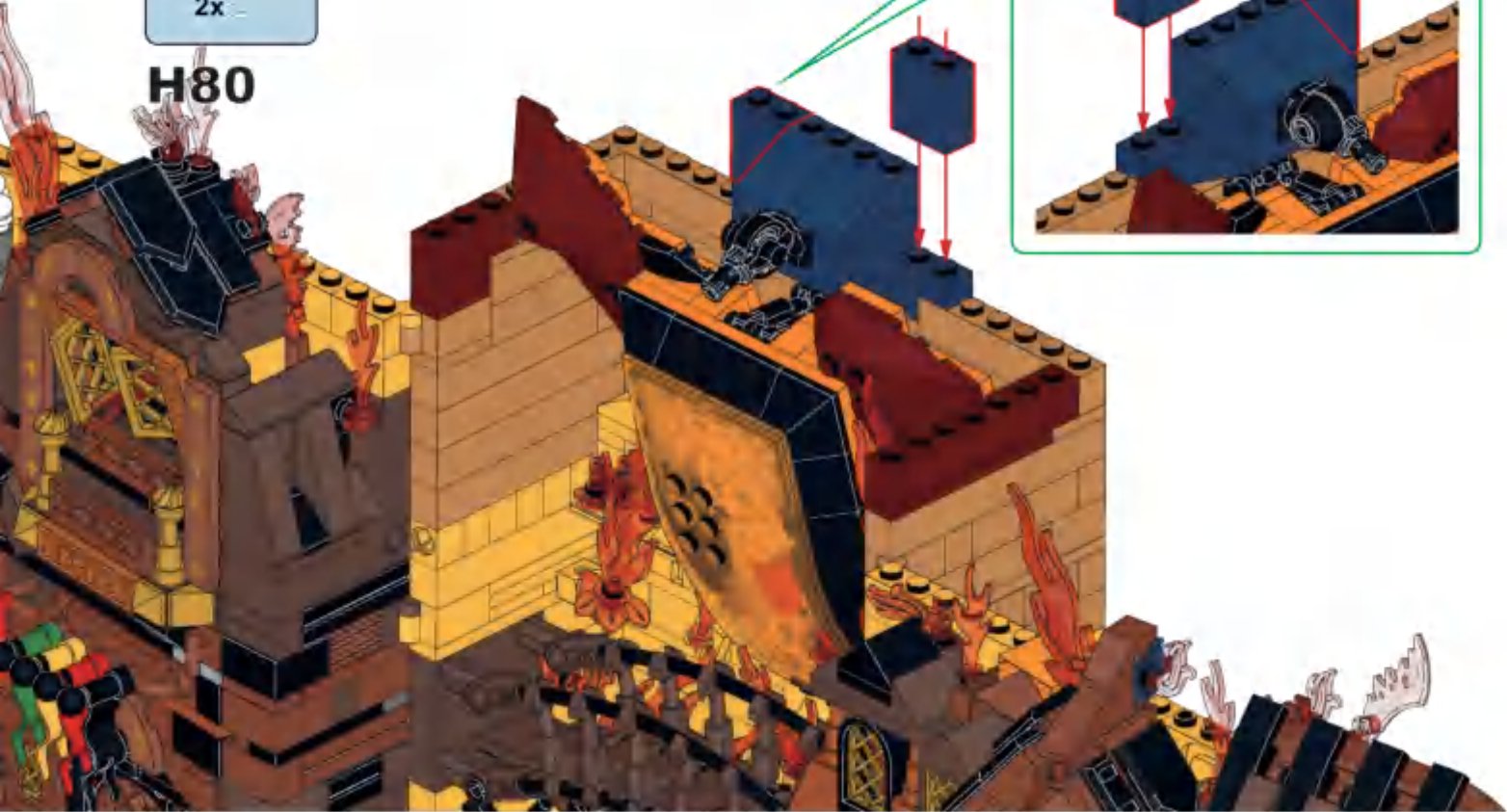

**H81**



**H82**



**H83**



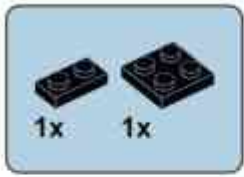

**H84**



**H85**

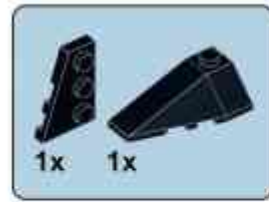

**H86**



**H87**



**H88**

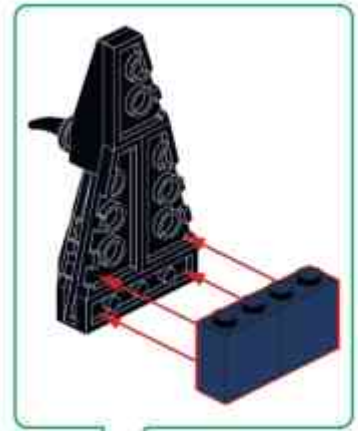
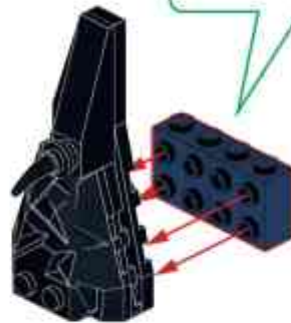

H89



H88

H80



H90



H91

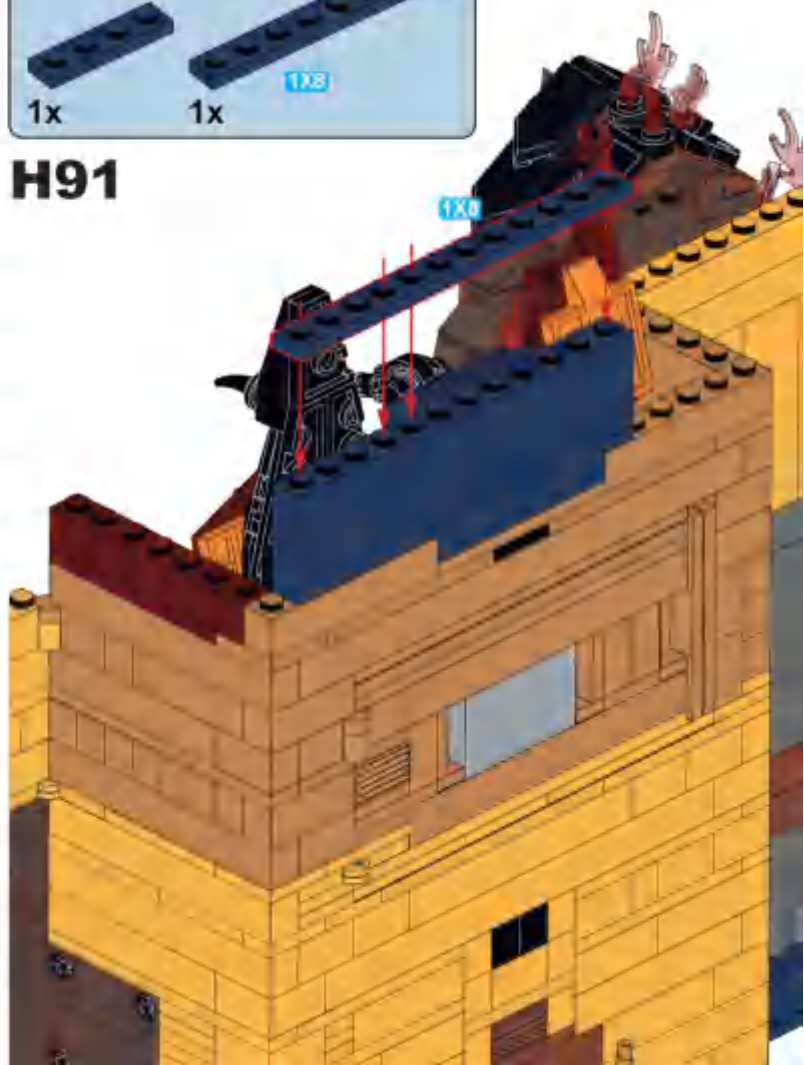



**H92**

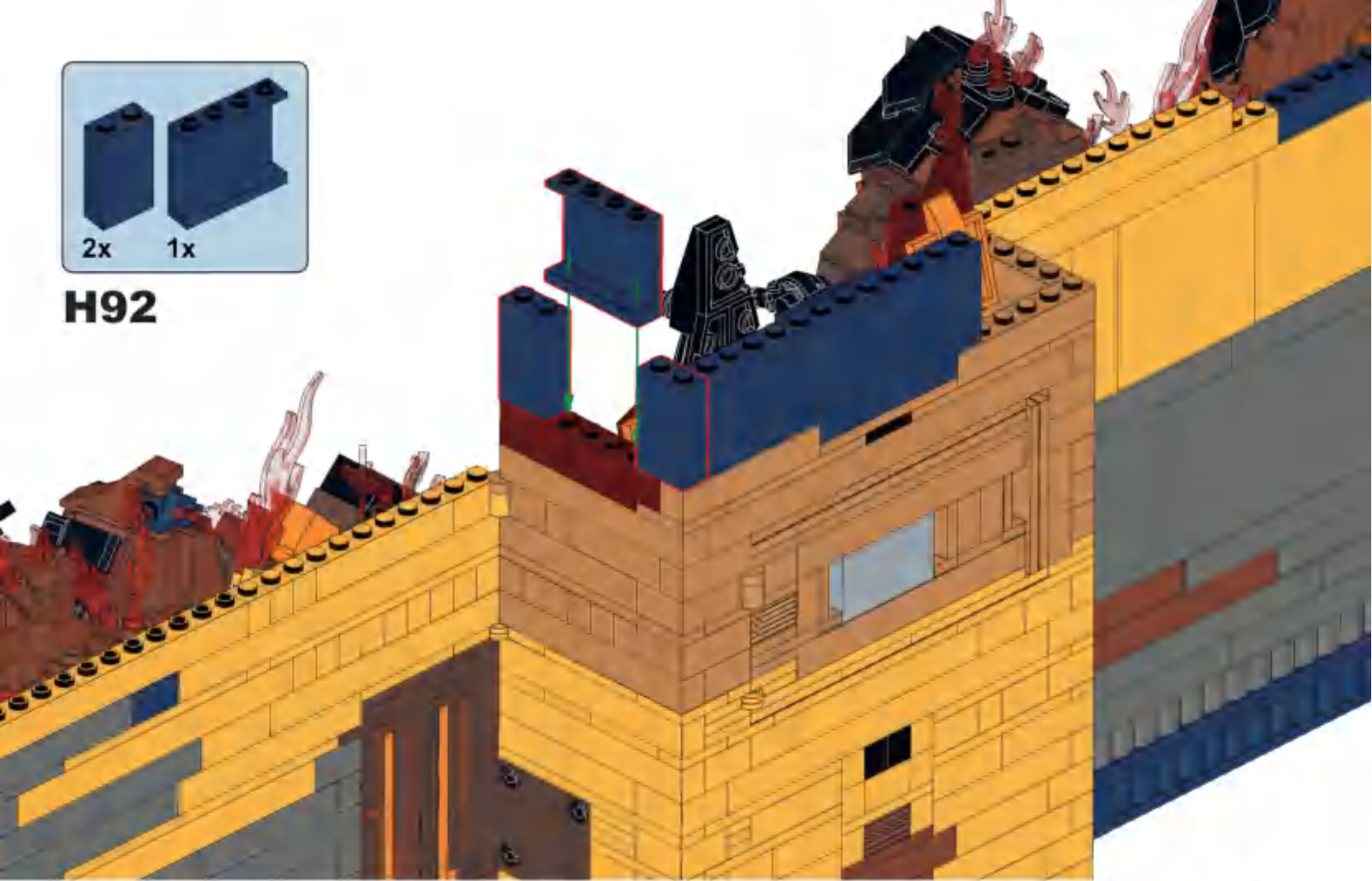

**H93**





**H94**

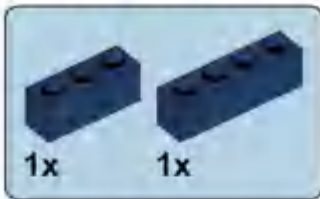
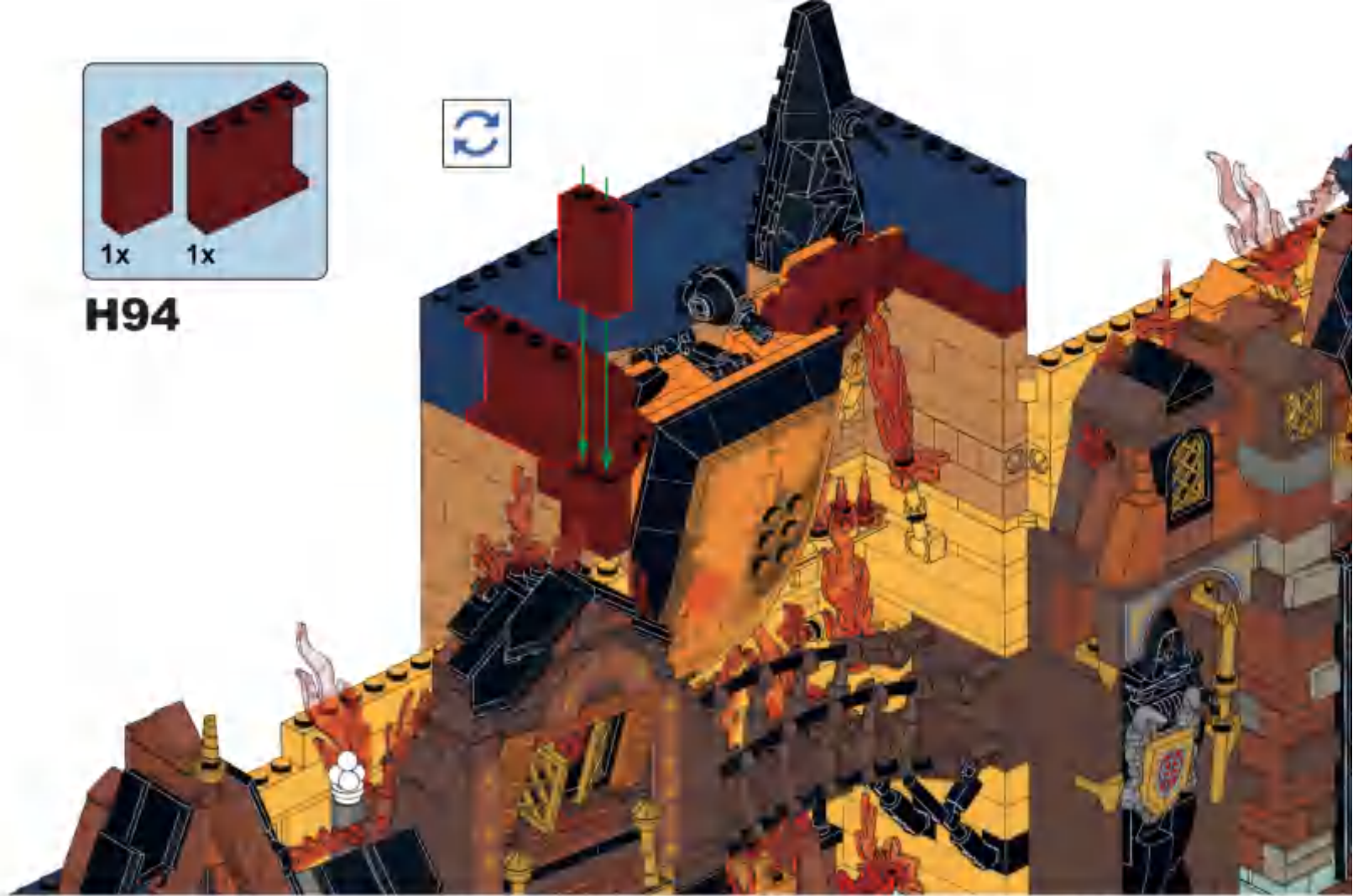

**H95**

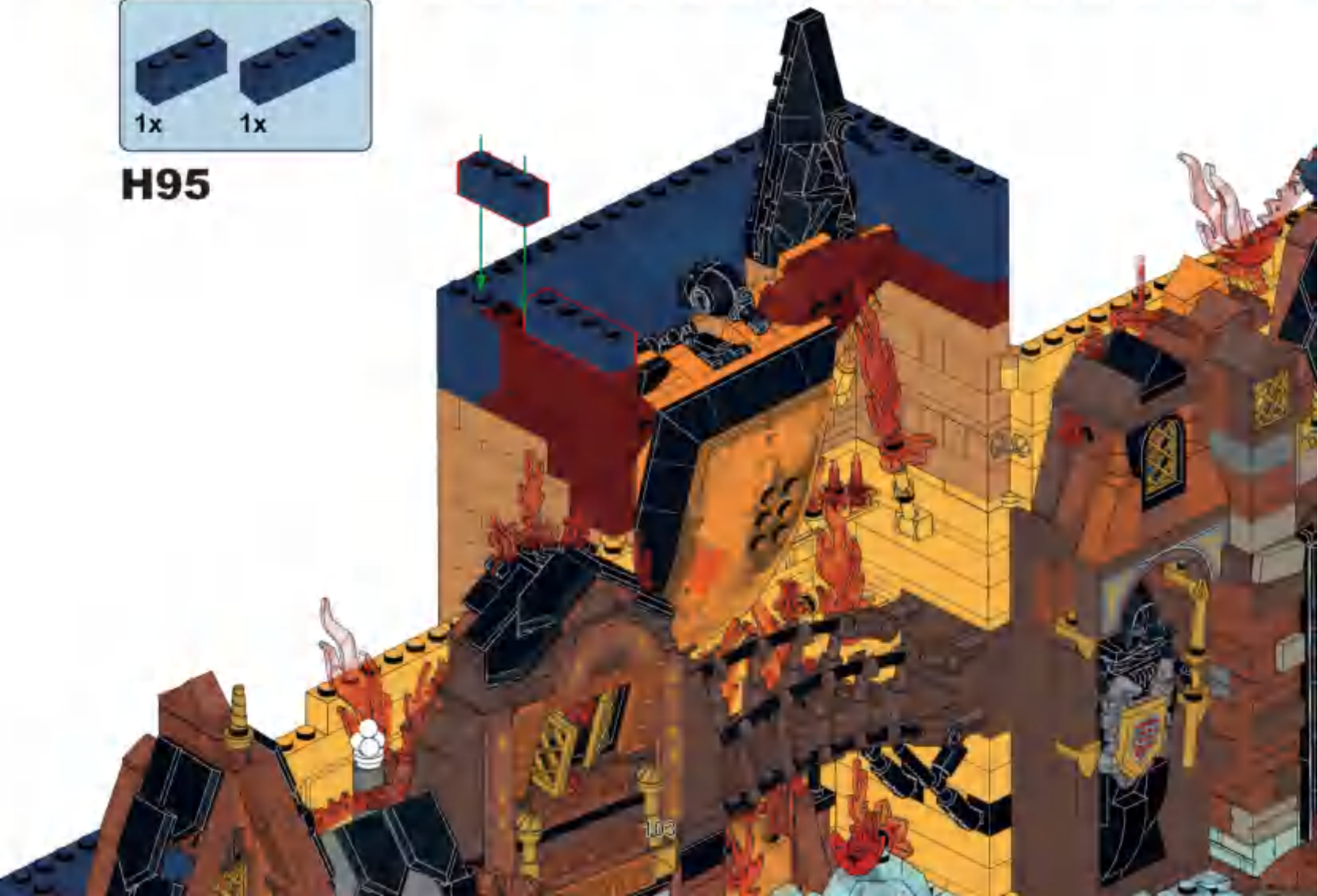

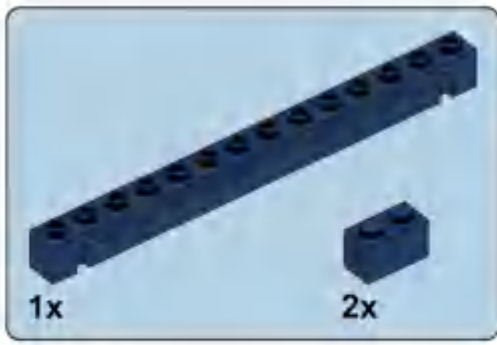

**H96**

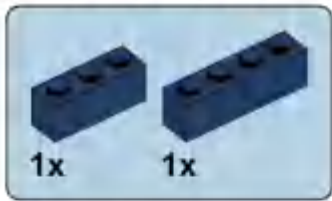
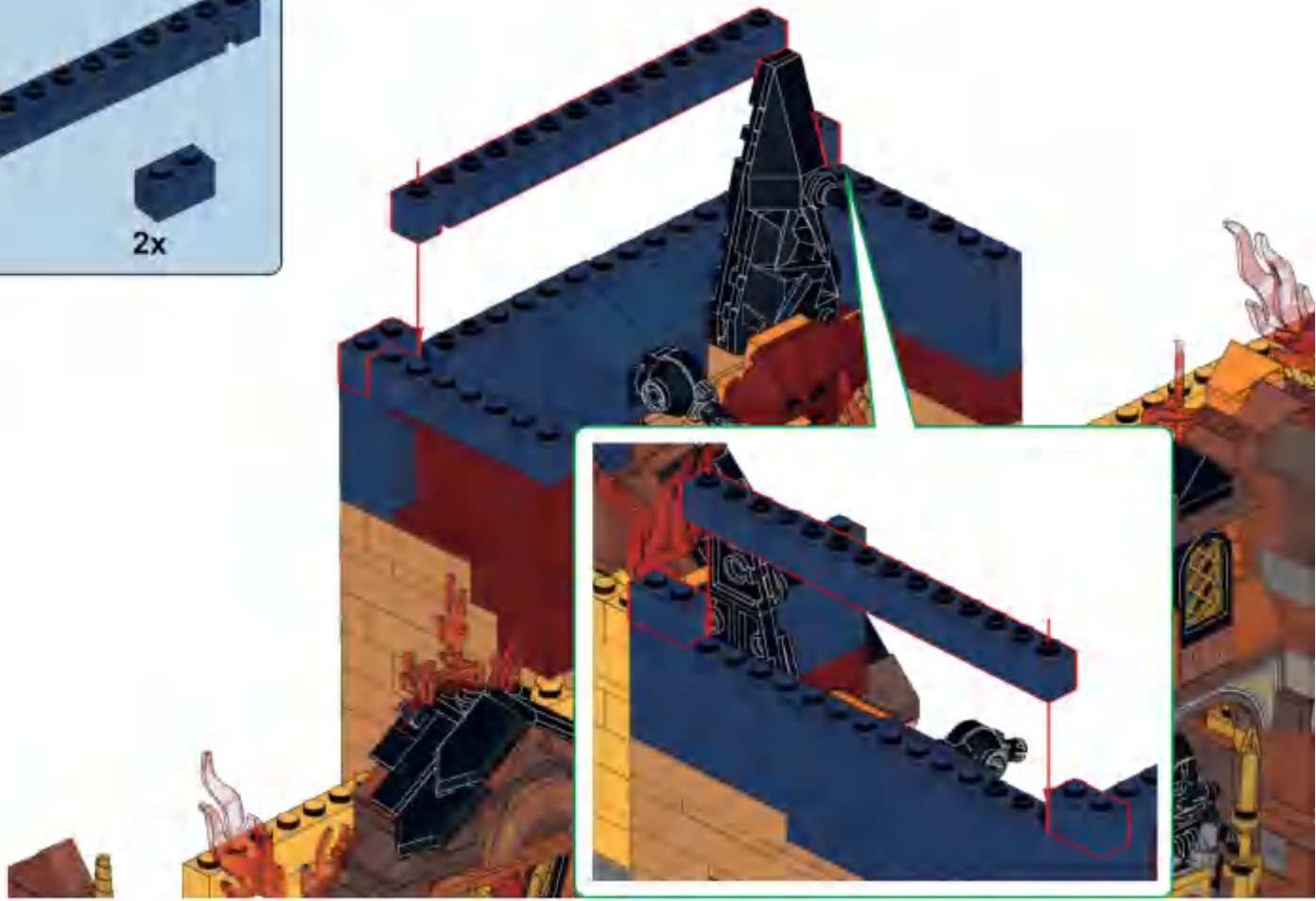

**H97**

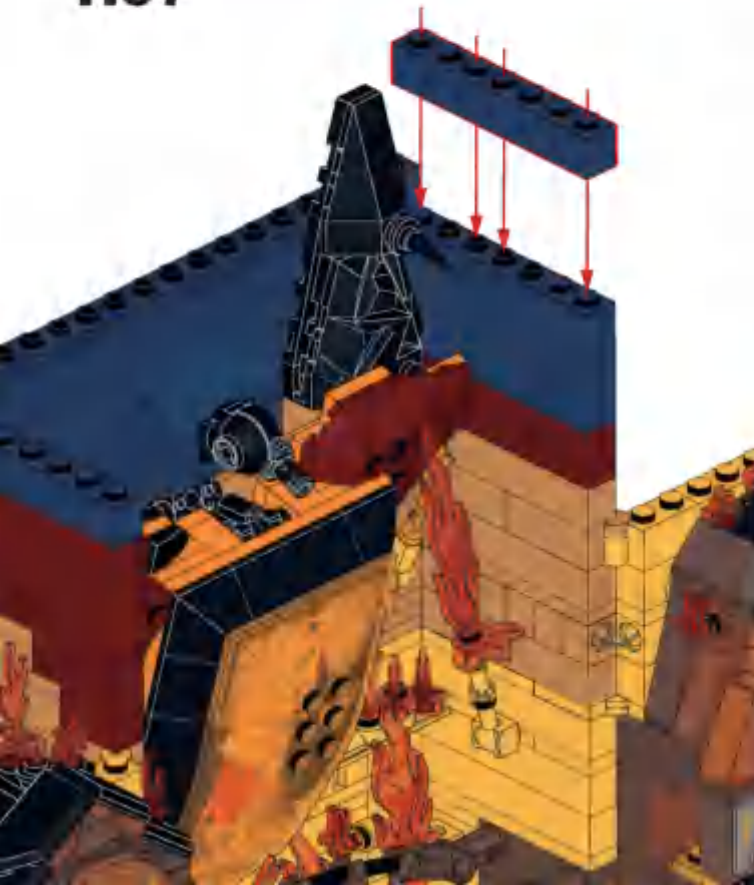

**H98**



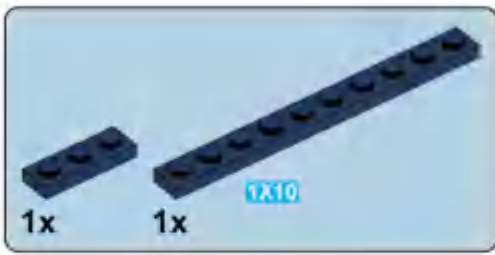

**H99**

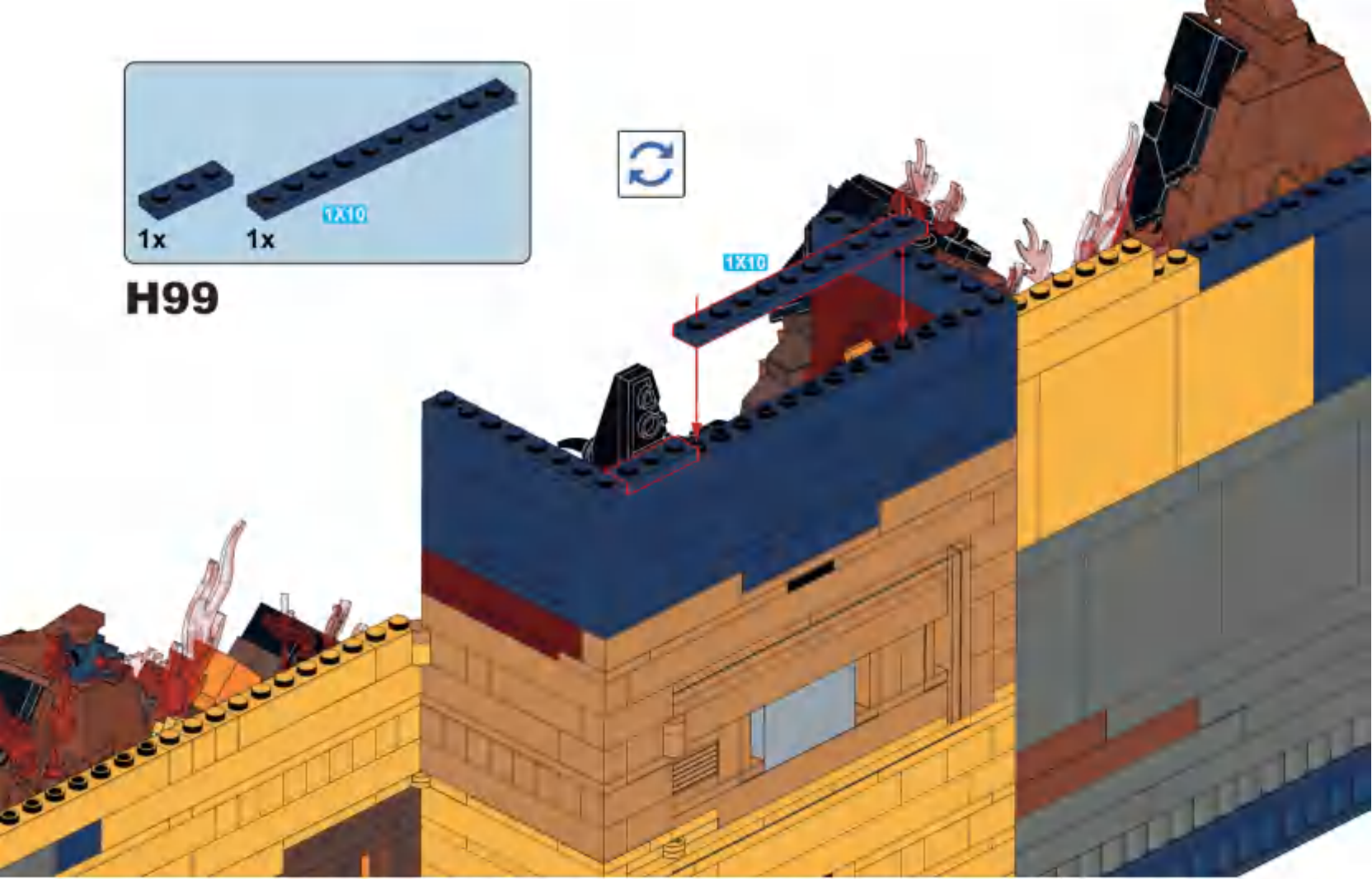

**H100**

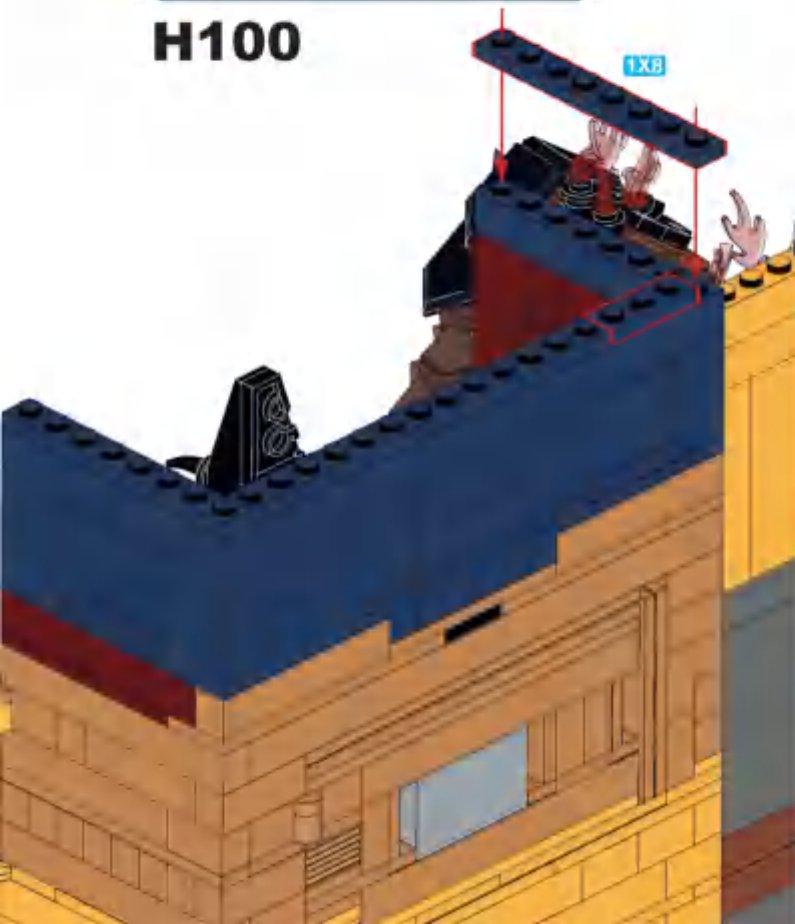

**H101**





**H102**

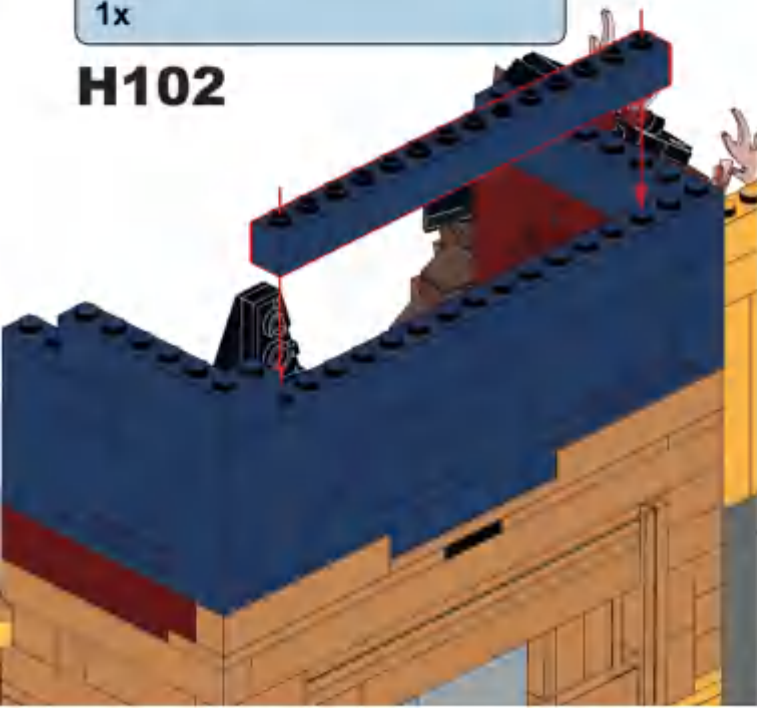

**H103**

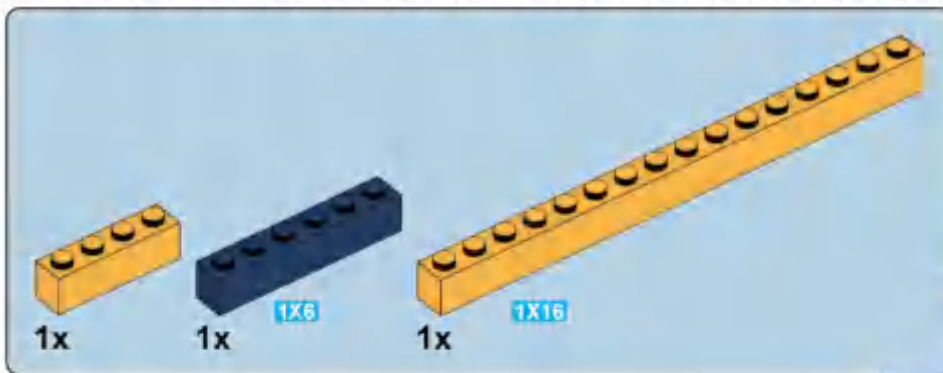

**H104**

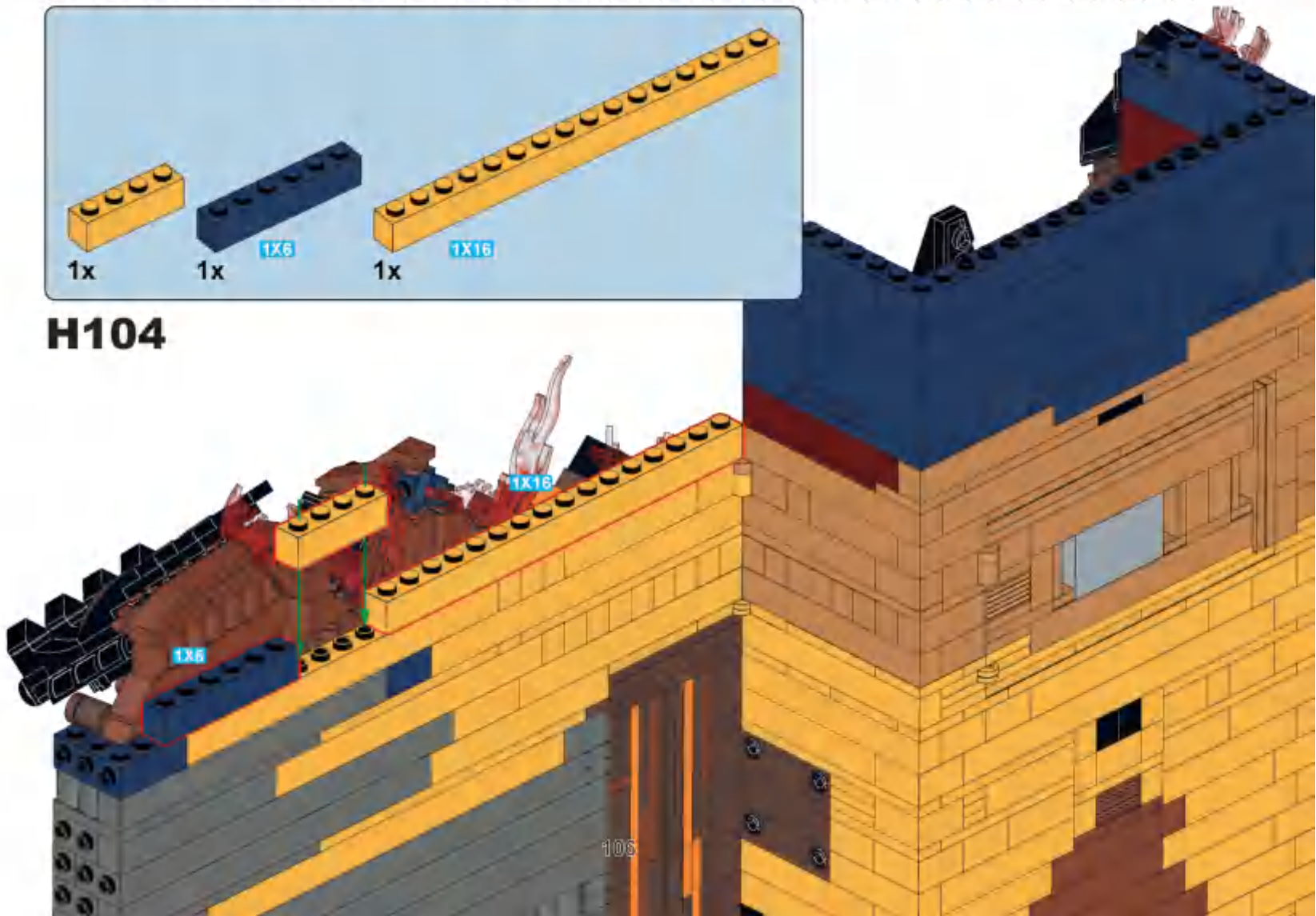



### H105

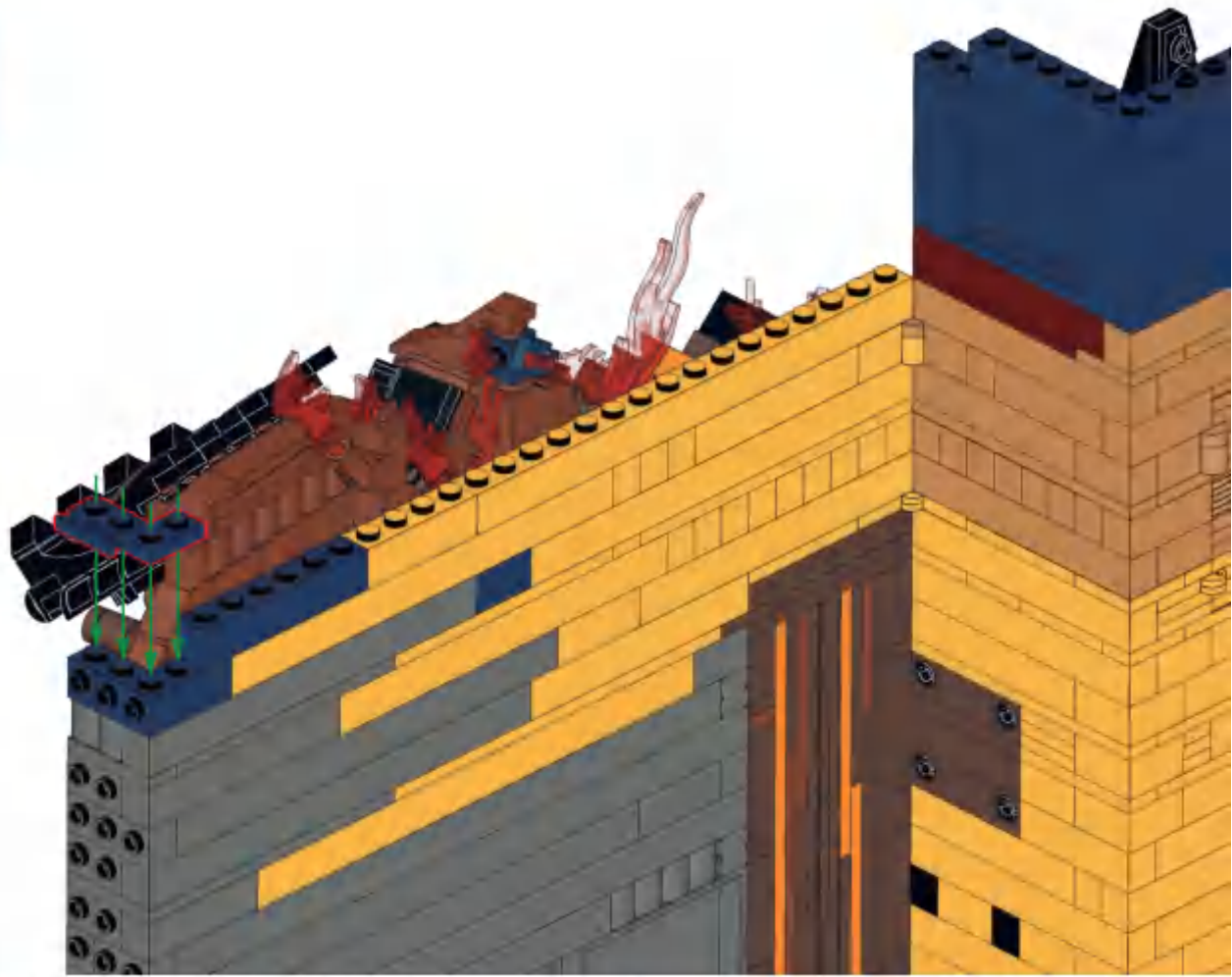

### H106

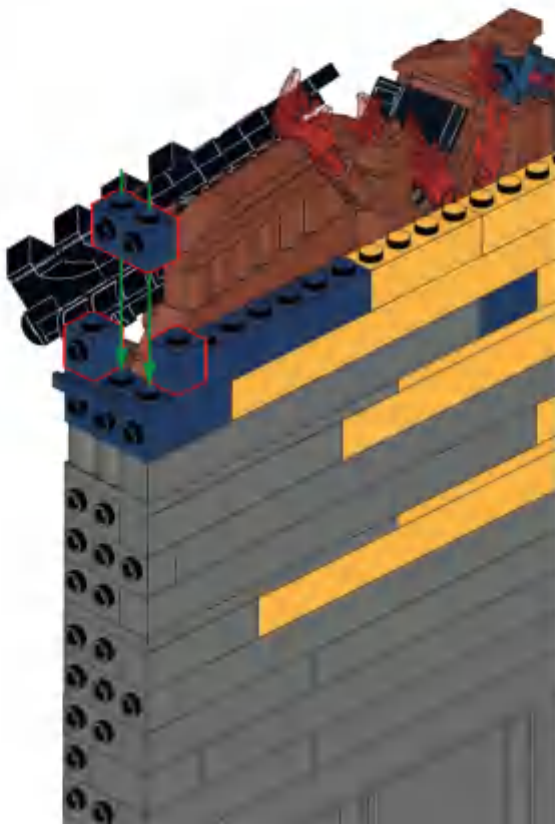

### H107

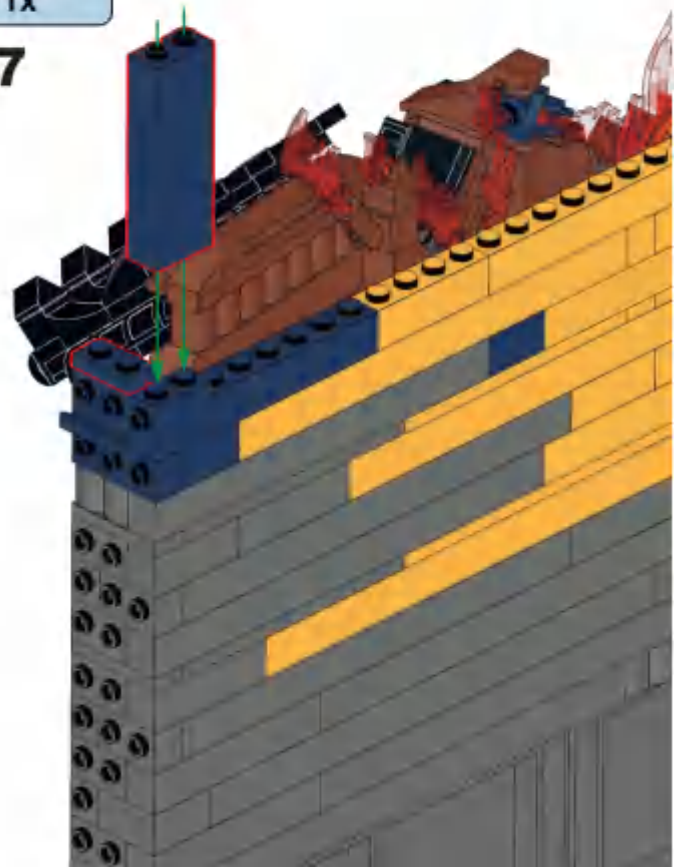

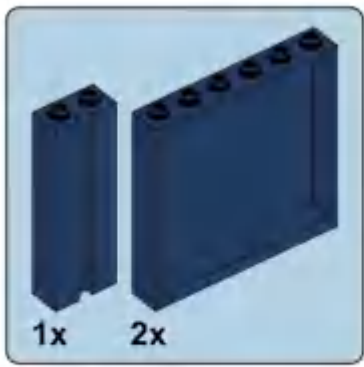

### H108

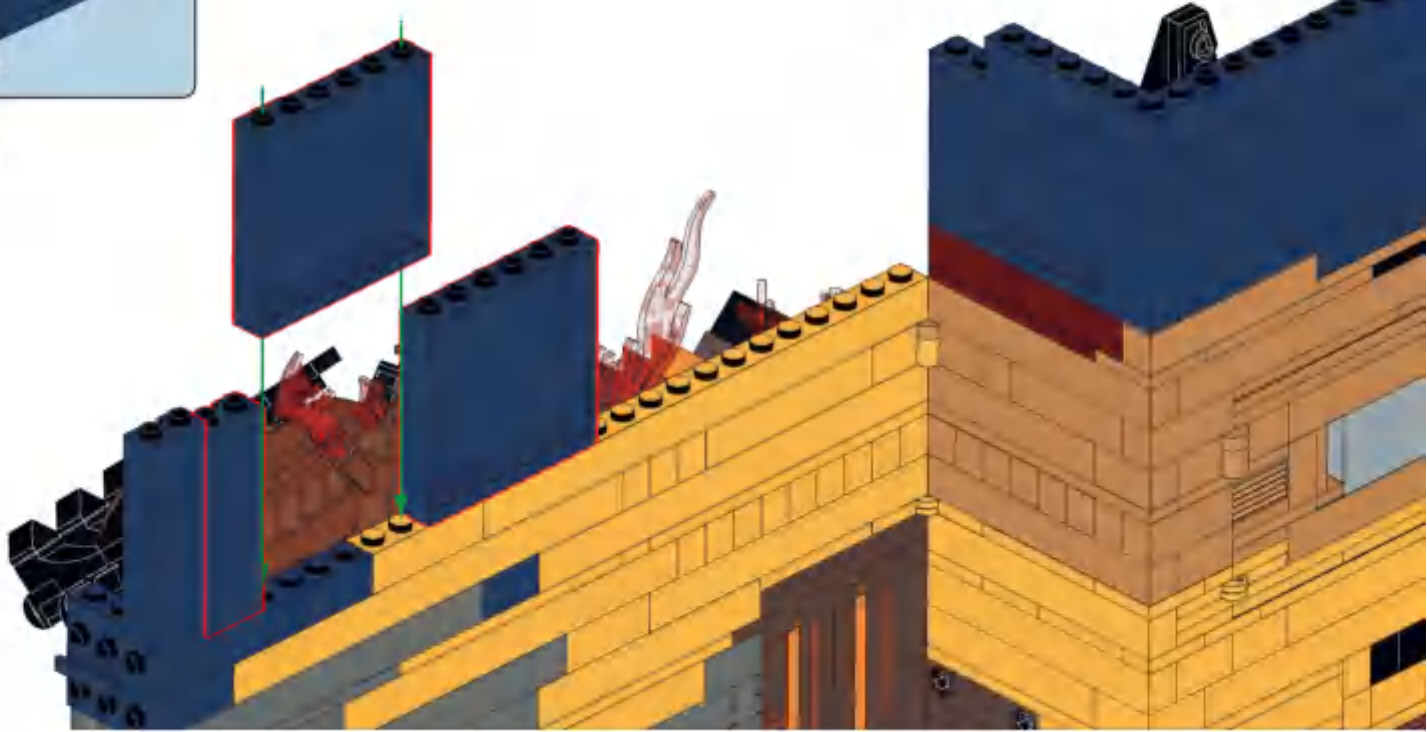

### H109

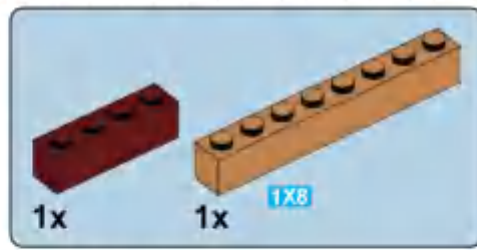
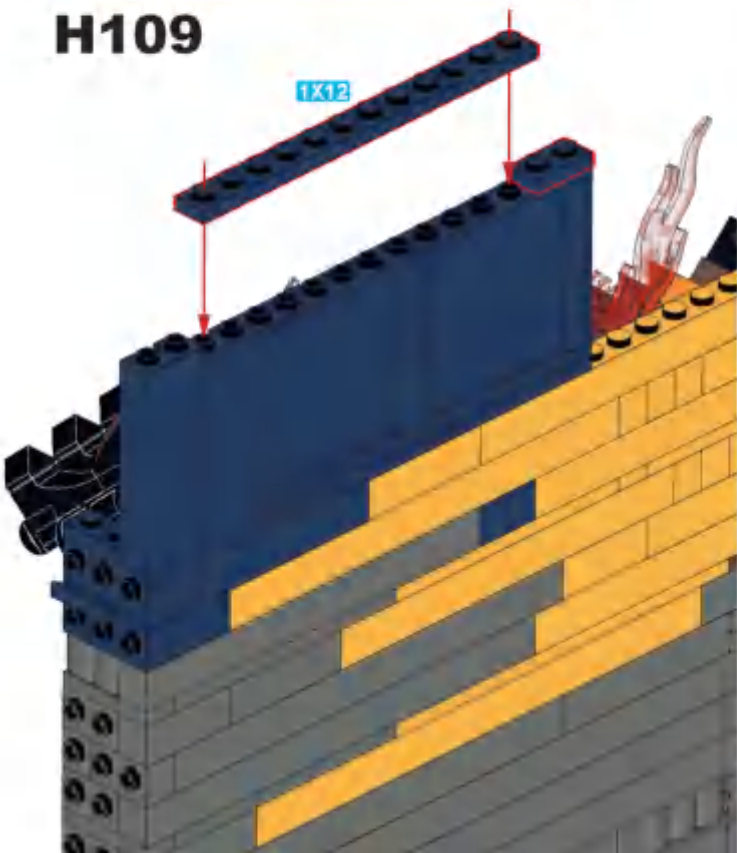

### H110

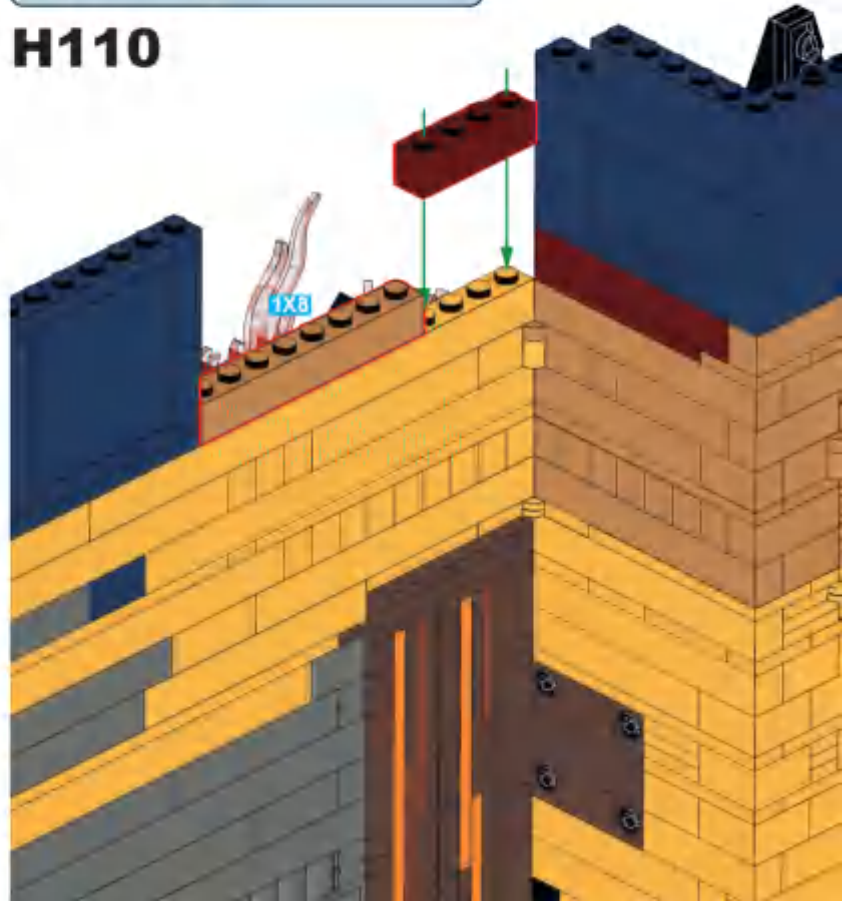



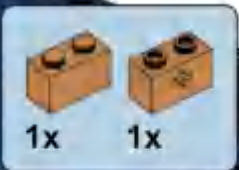

H114

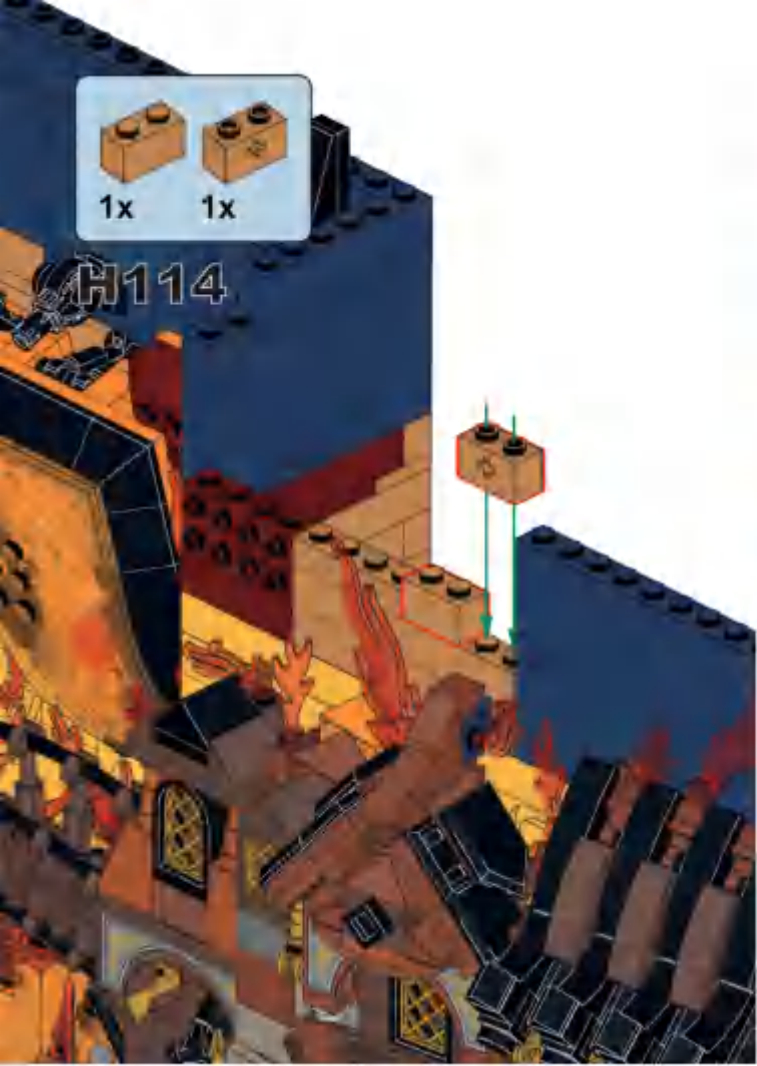

H115

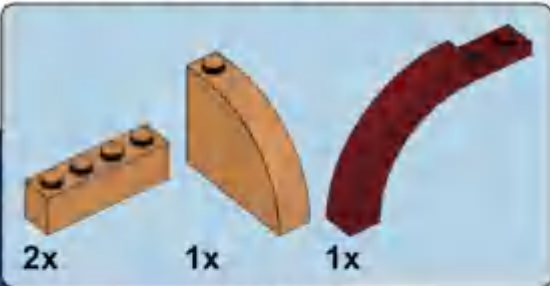
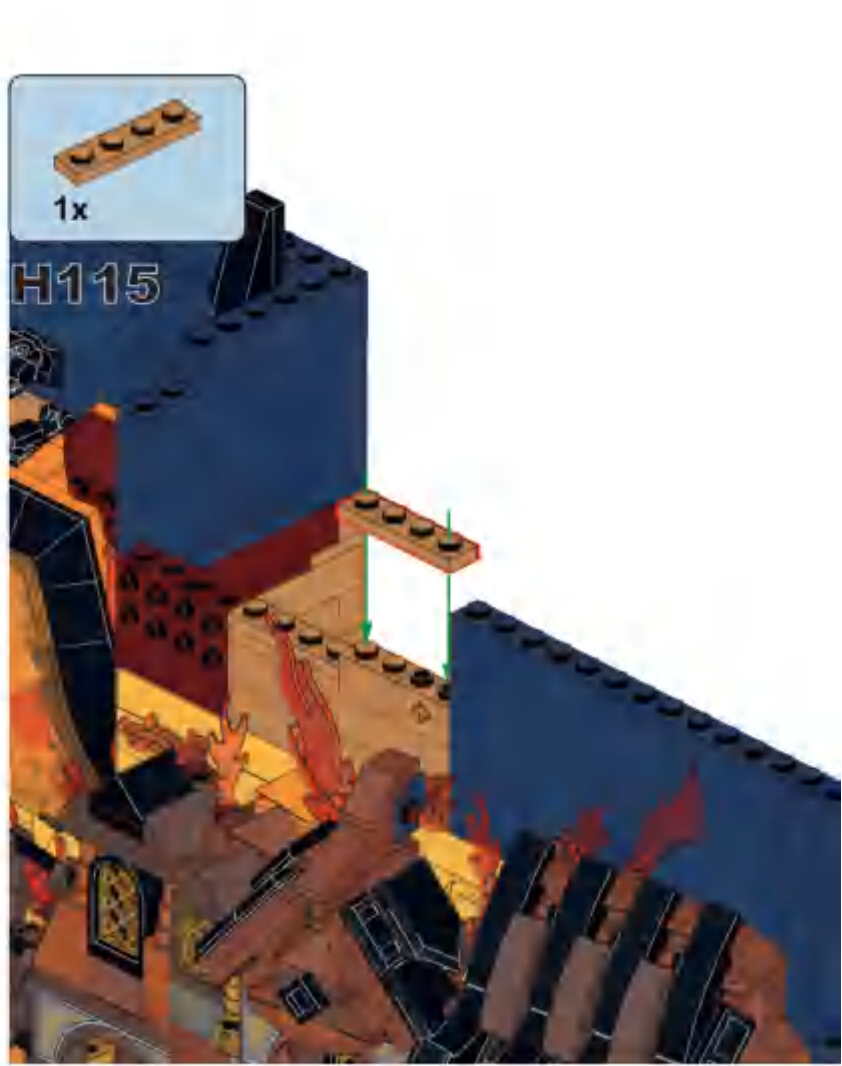

H116

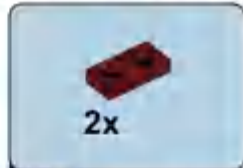

H117

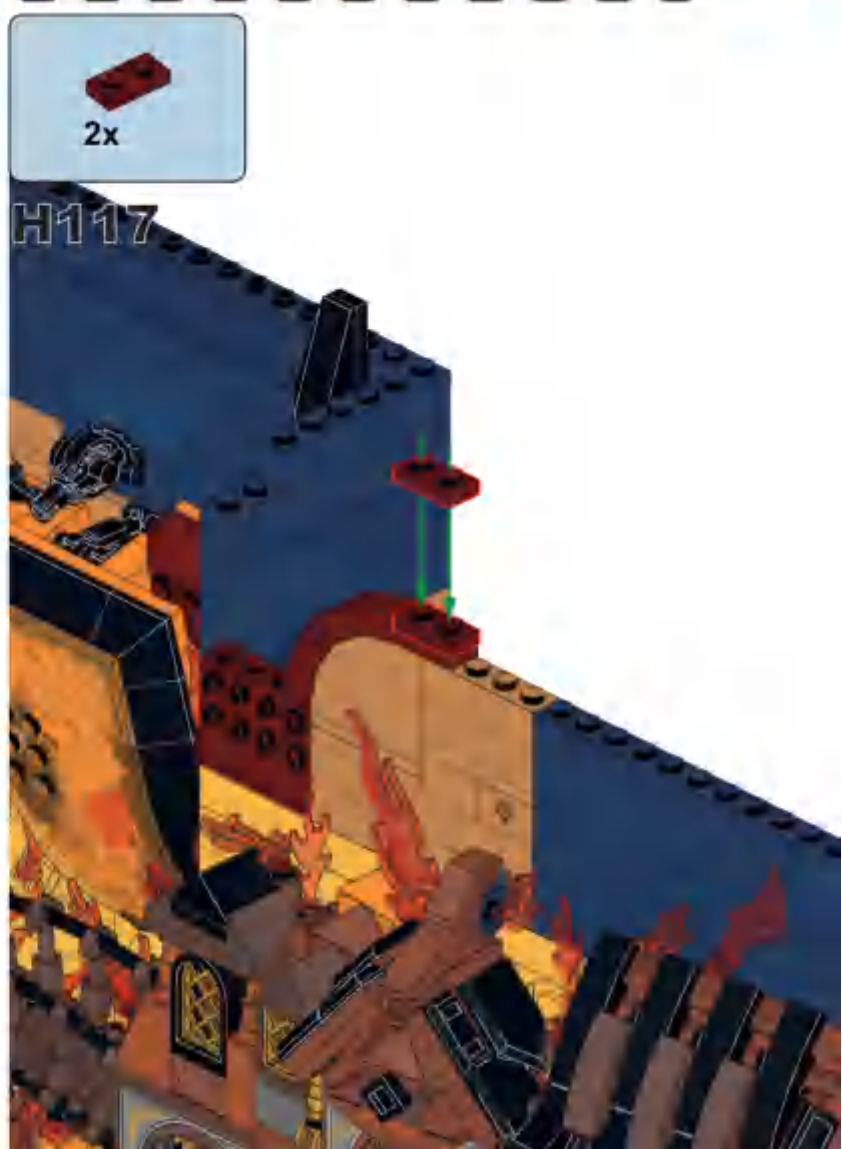

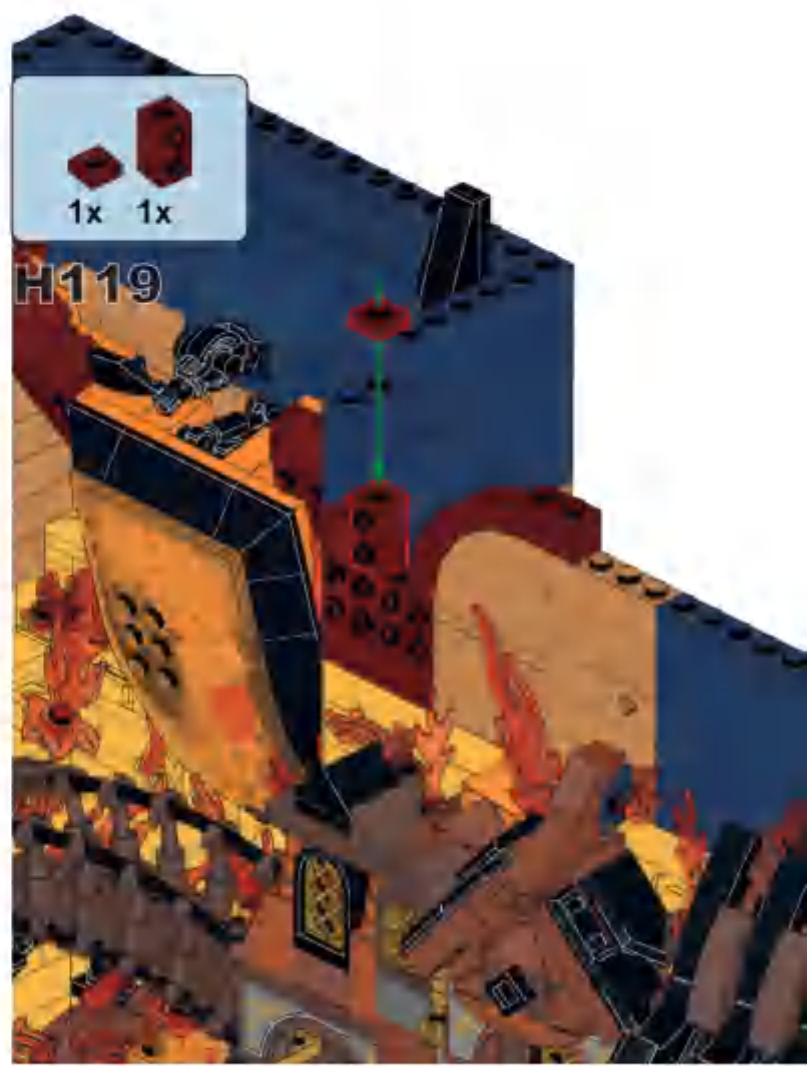

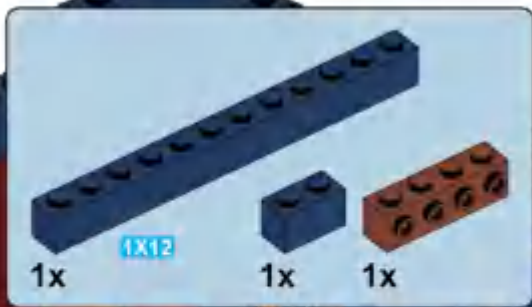

H122

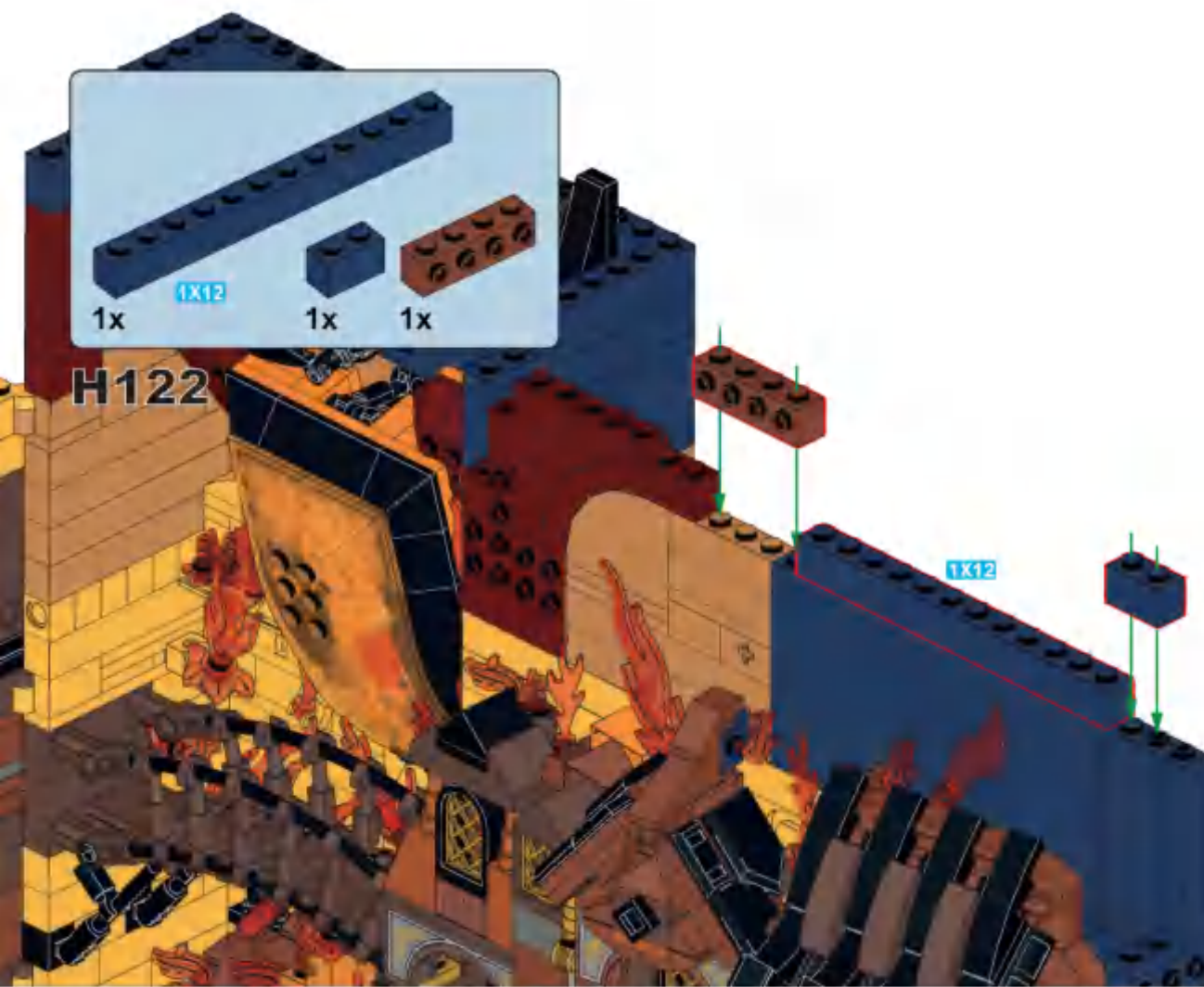

H123

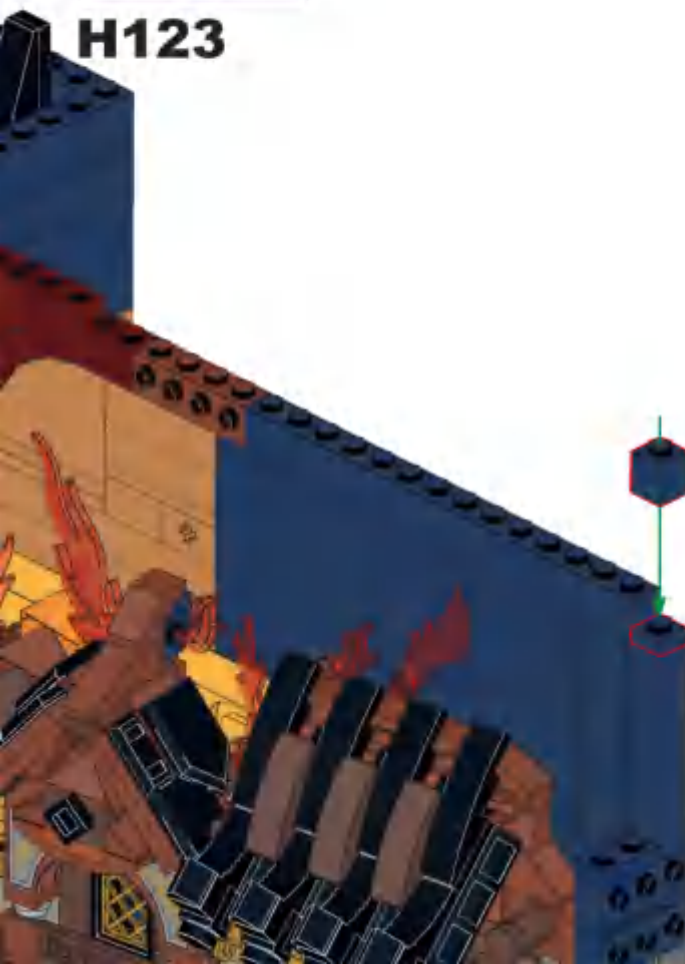

H124

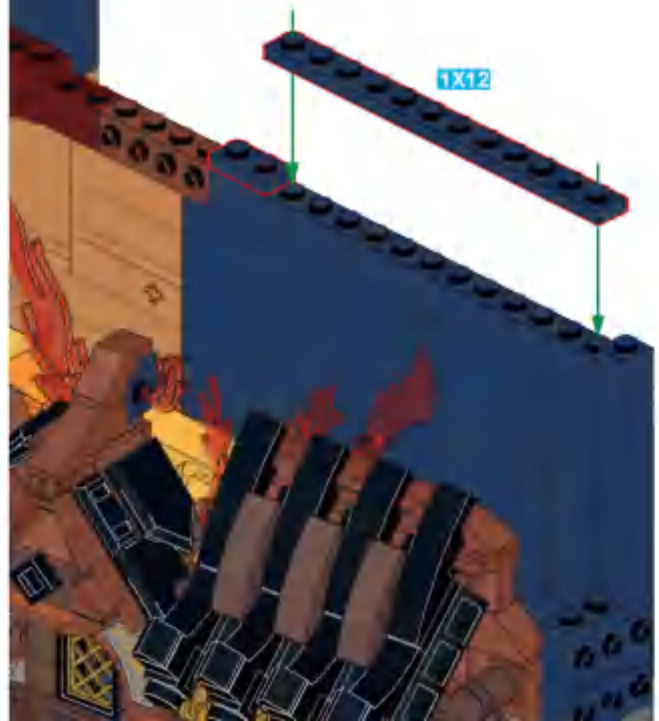



H125



H126

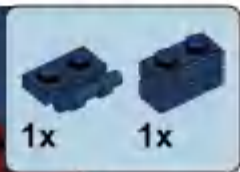
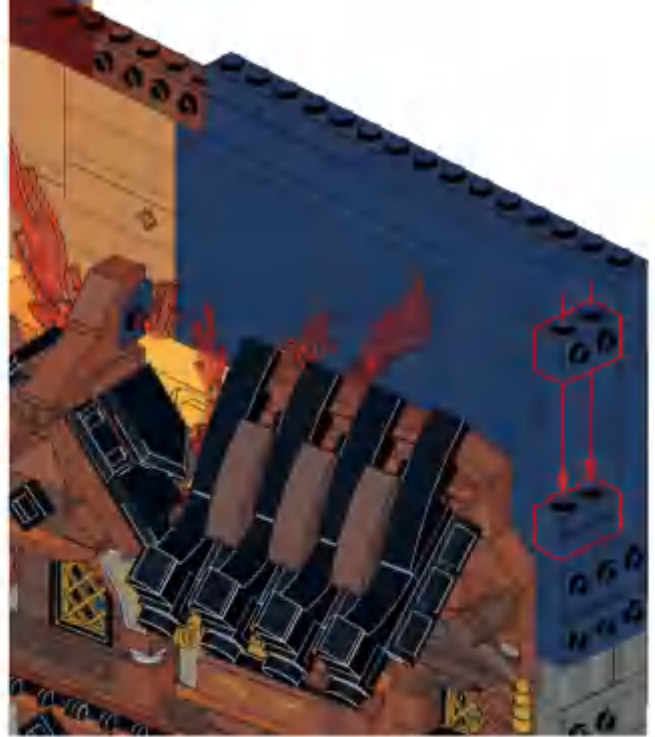

H127

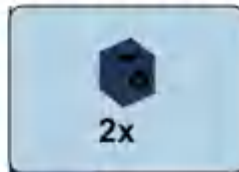

H128

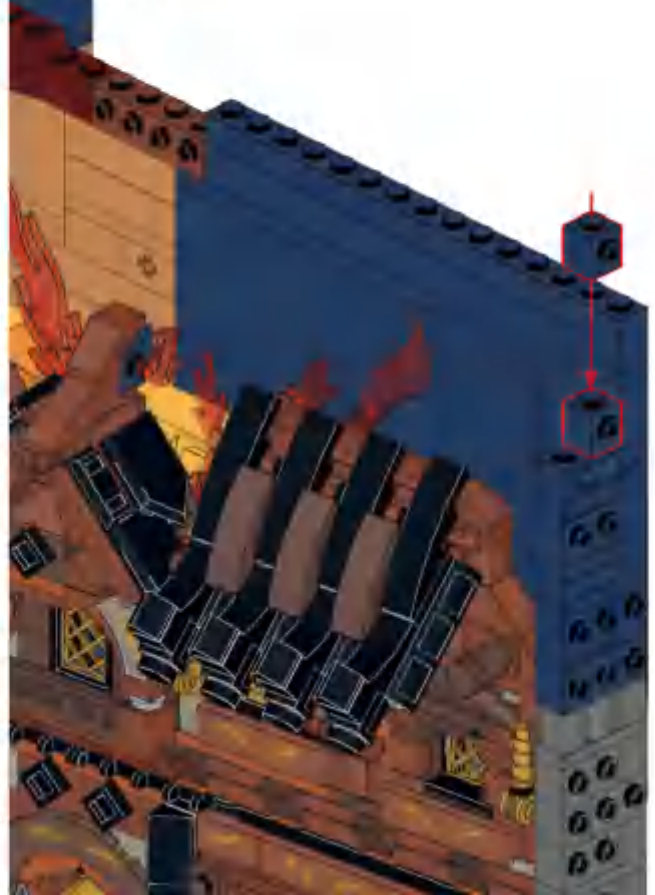



**H129**

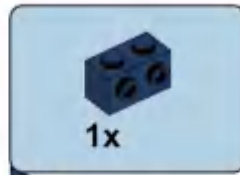

**H130**

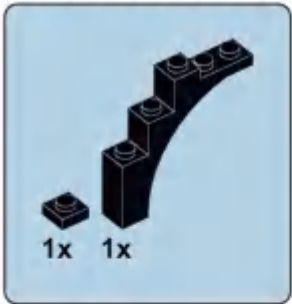
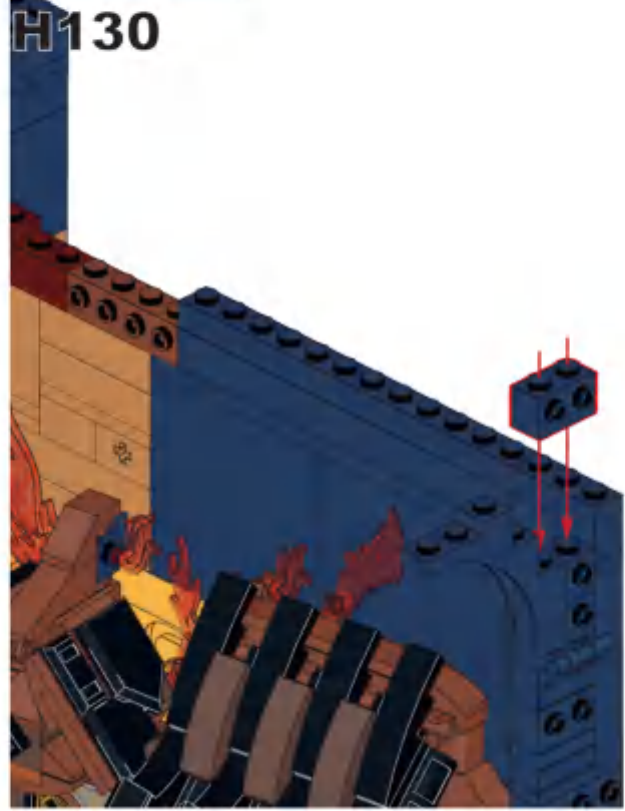

**H131**

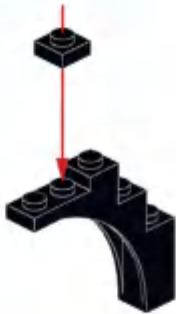

**H132**

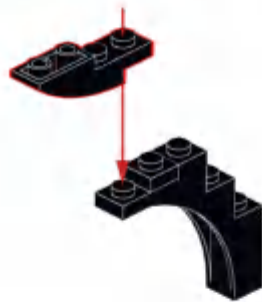

**H133**

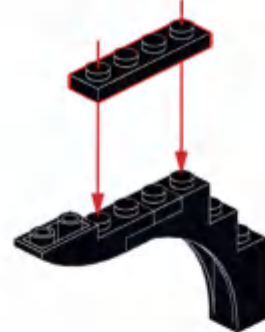

H134

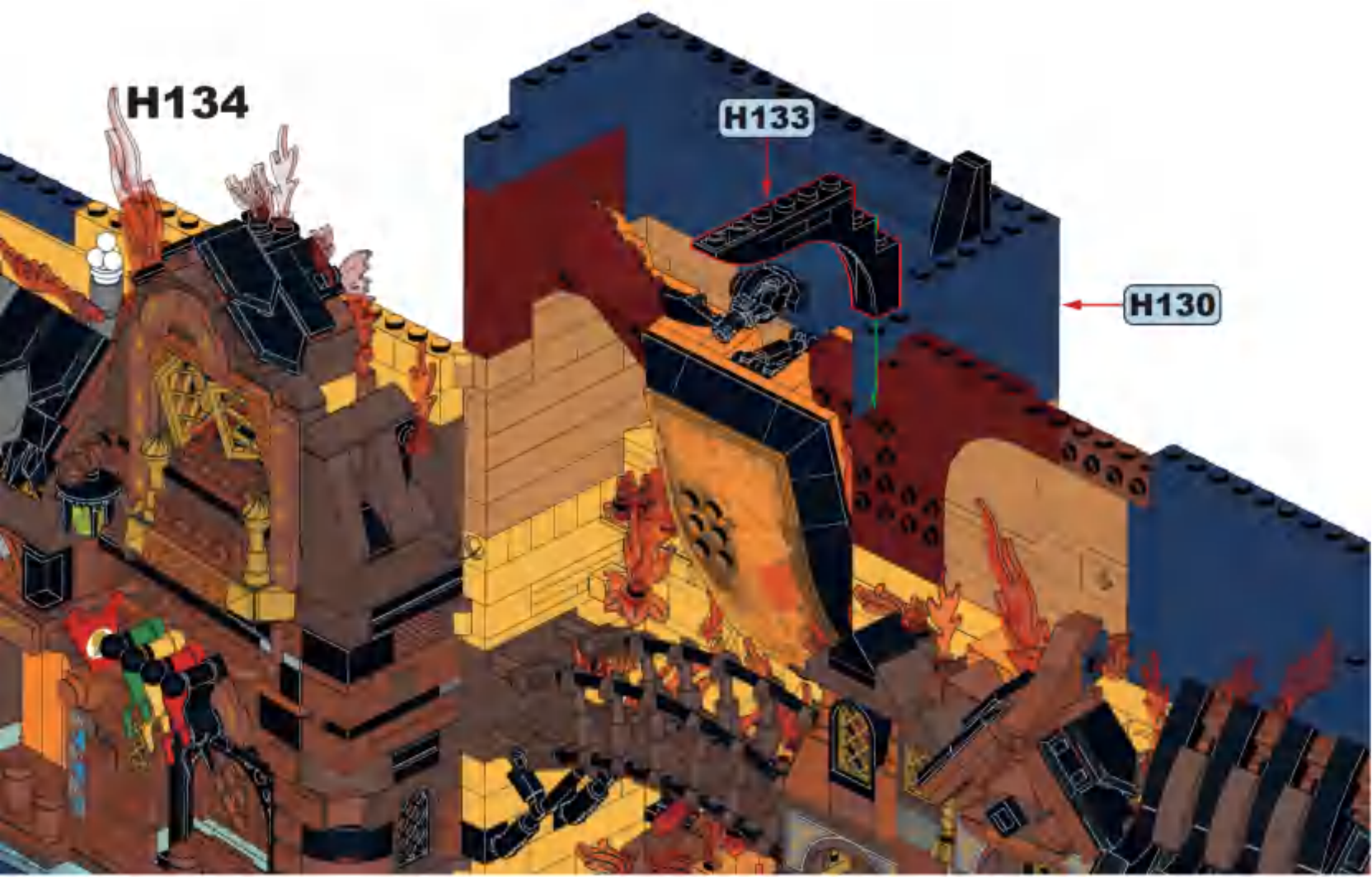

H133

H130



H135

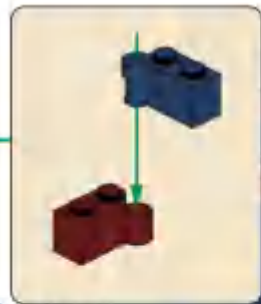



### H136

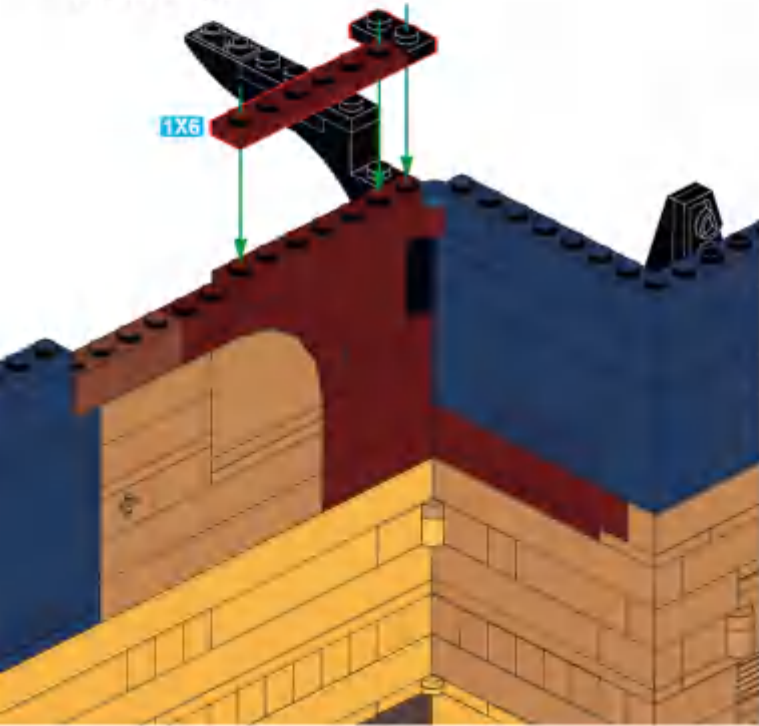

### H137

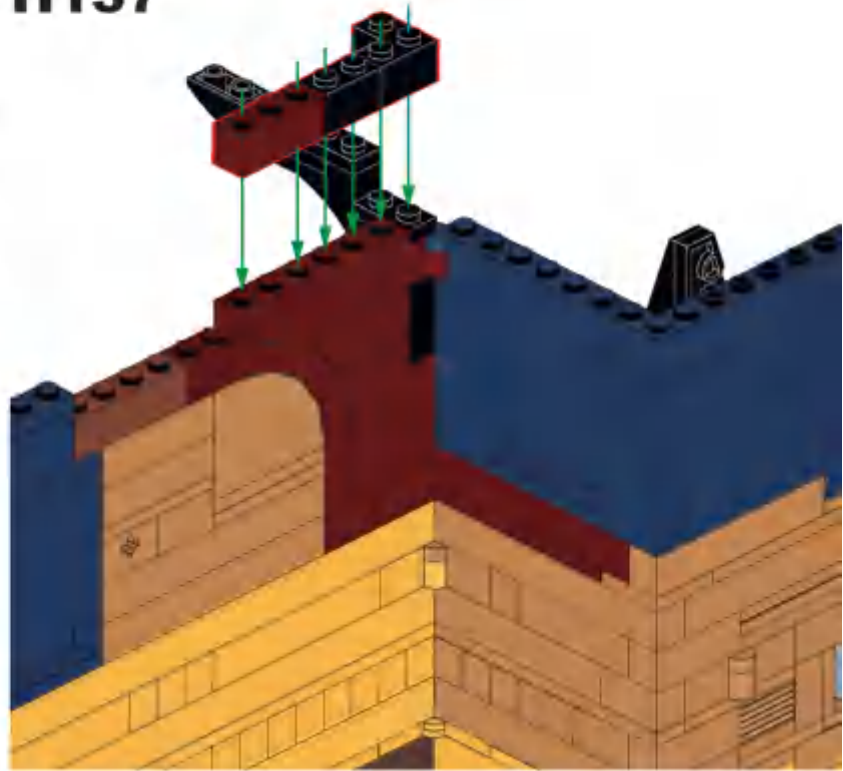

### H138

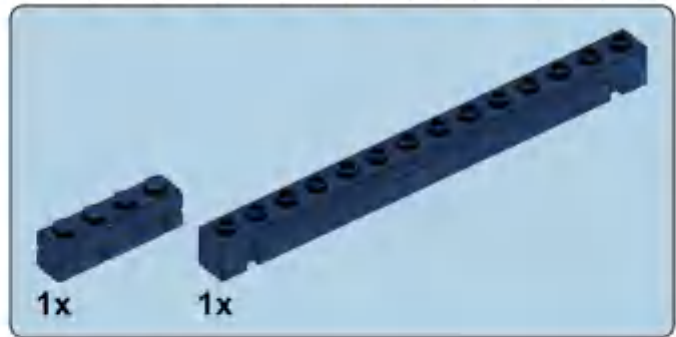

### H139

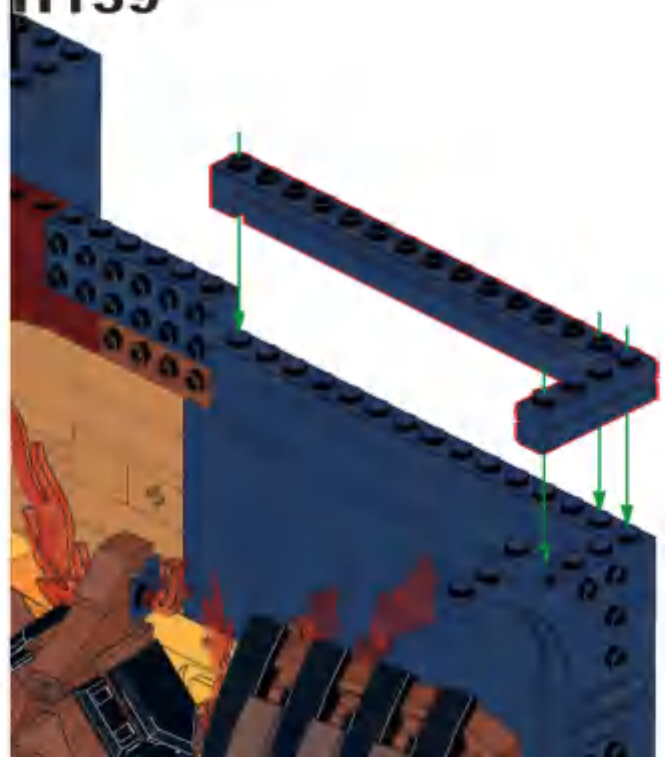

9



I



I1



I2

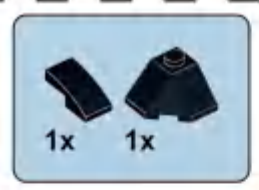
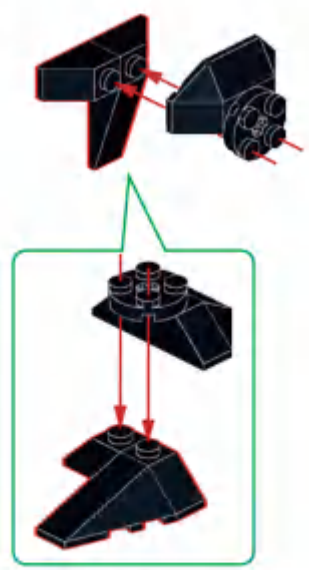

I3

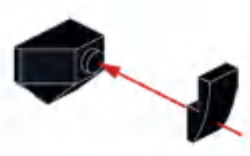

**14**



**15**

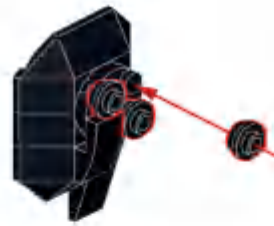

**16**



**17**



**H139**



**16**





**18**

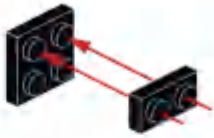

**19**

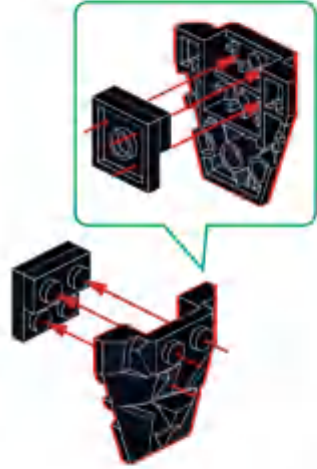

**110**

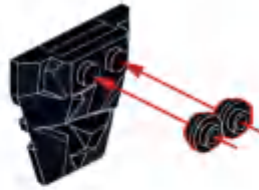

**111**

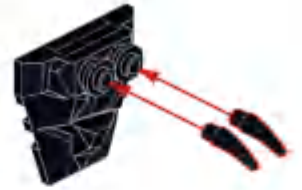

**112**





I13



I14

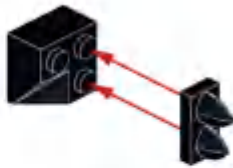

I15



I16

I13

I15

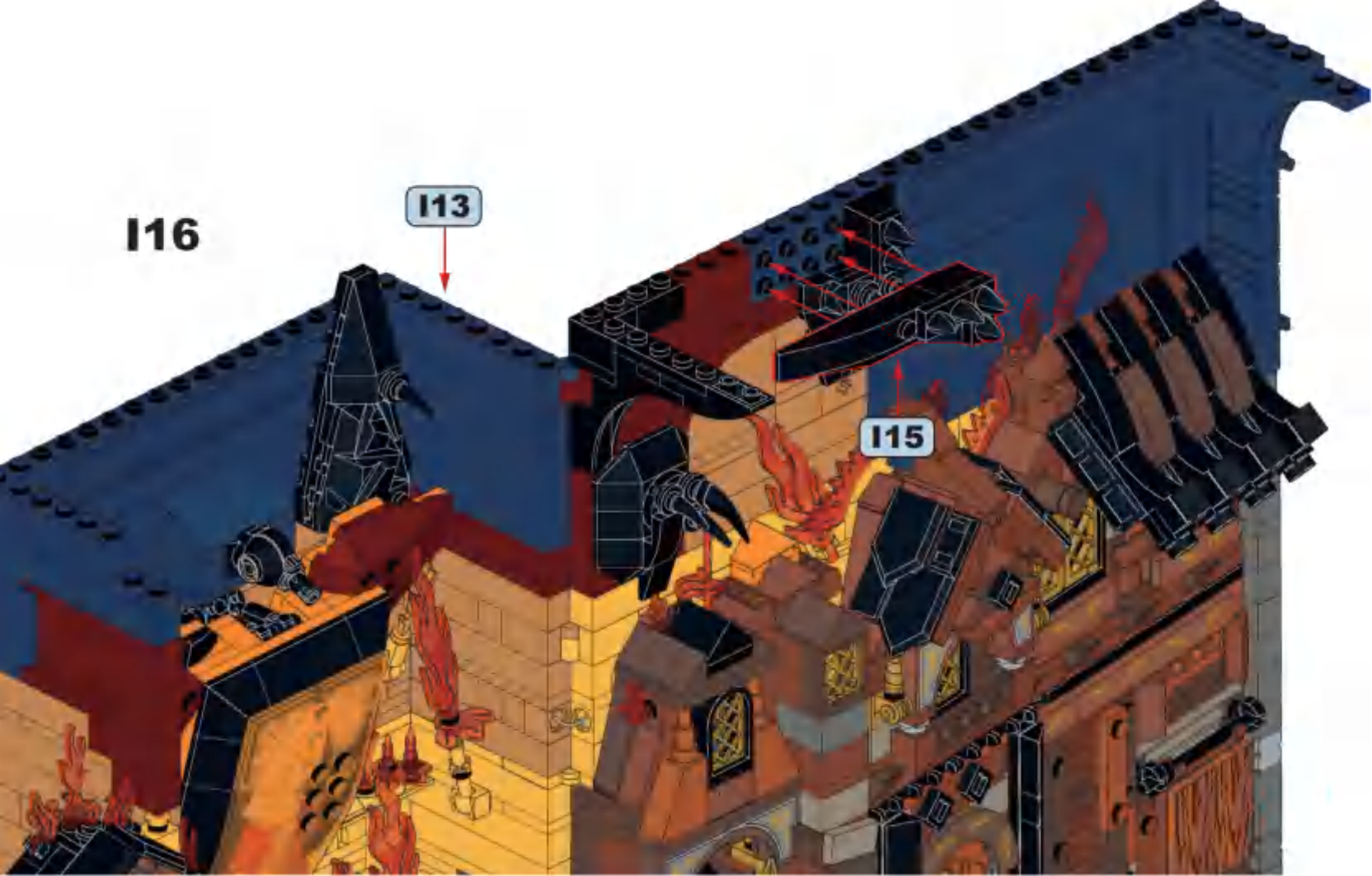

I17

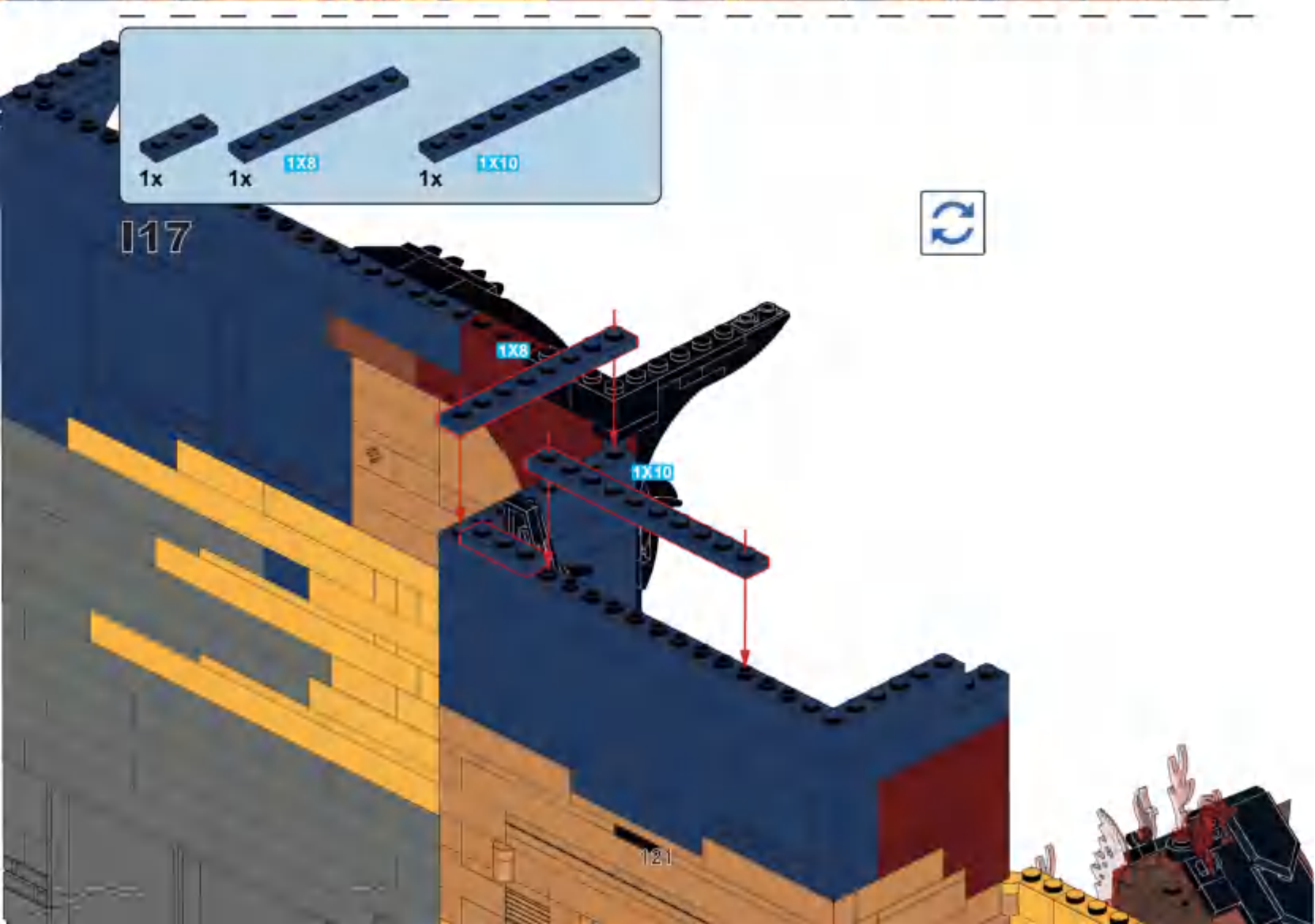

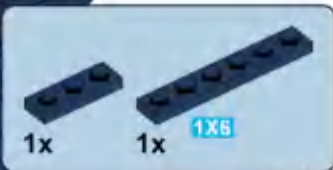

118

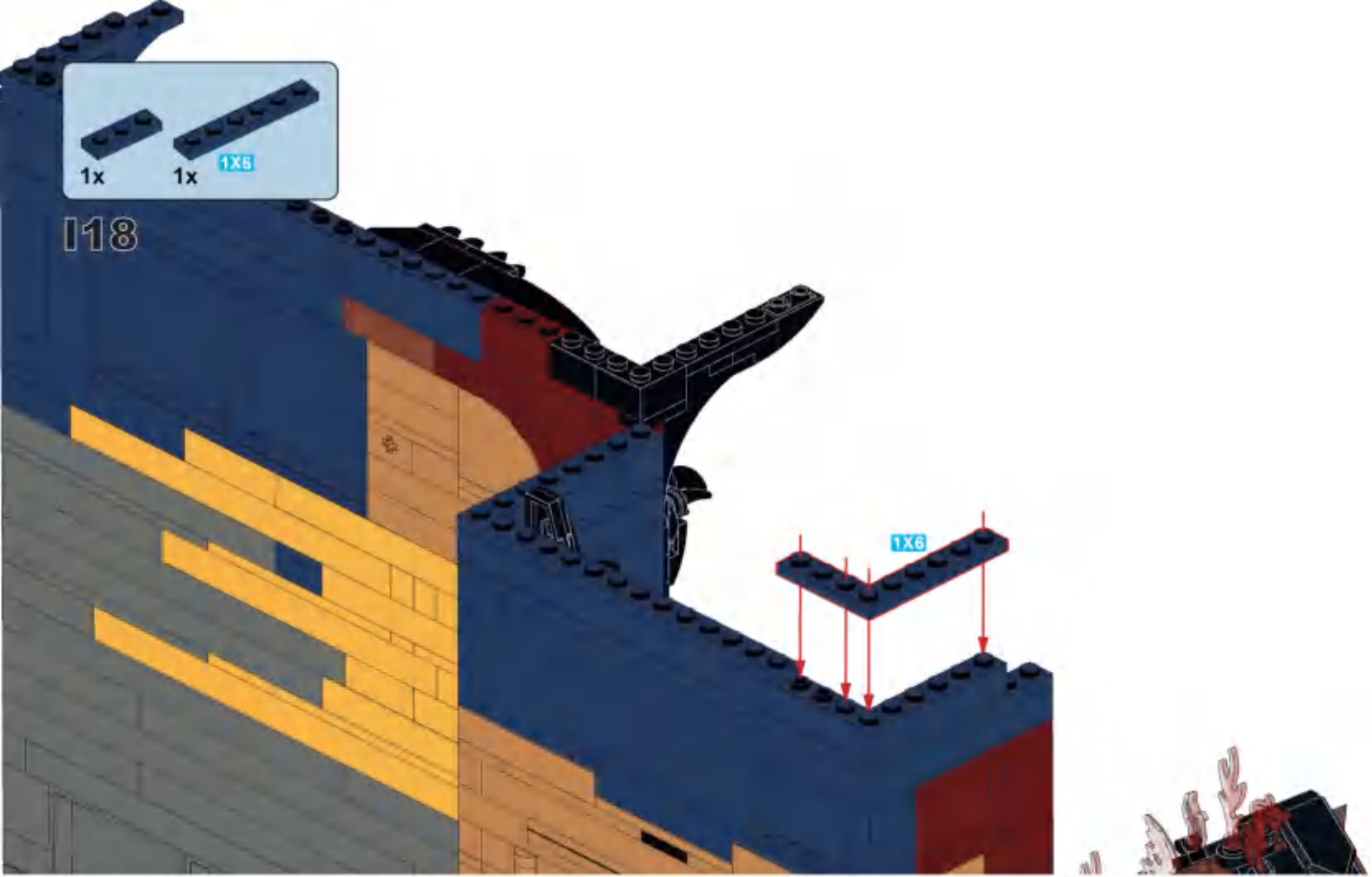

119





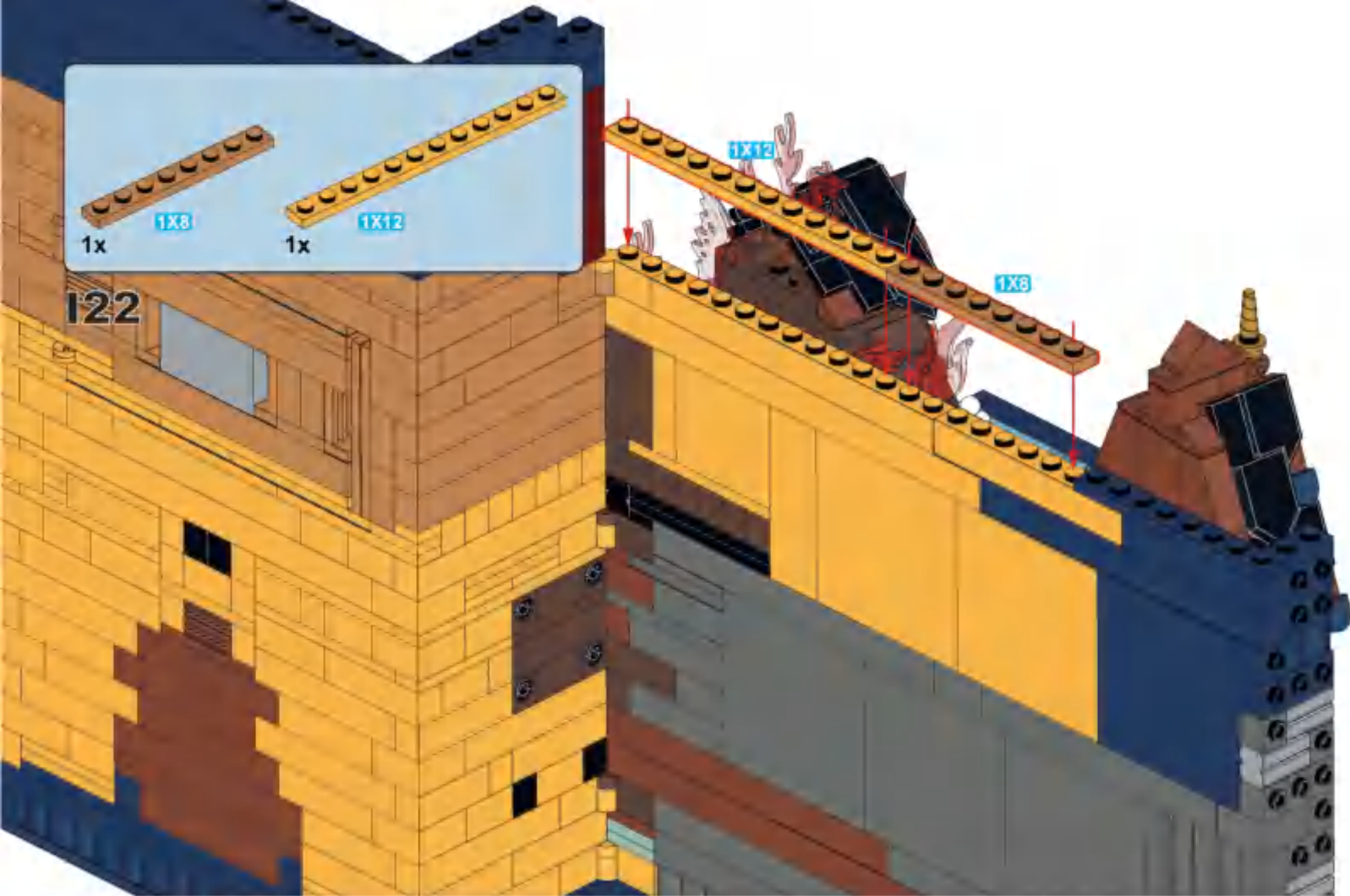



**124**

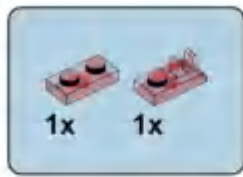

**125**

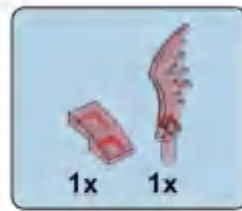
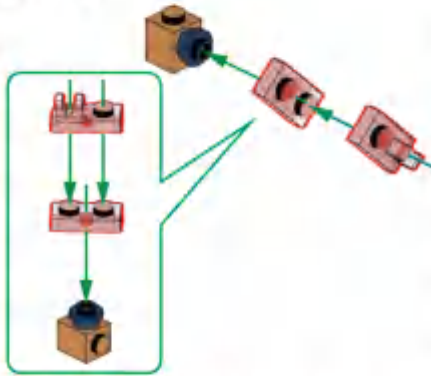

**126**

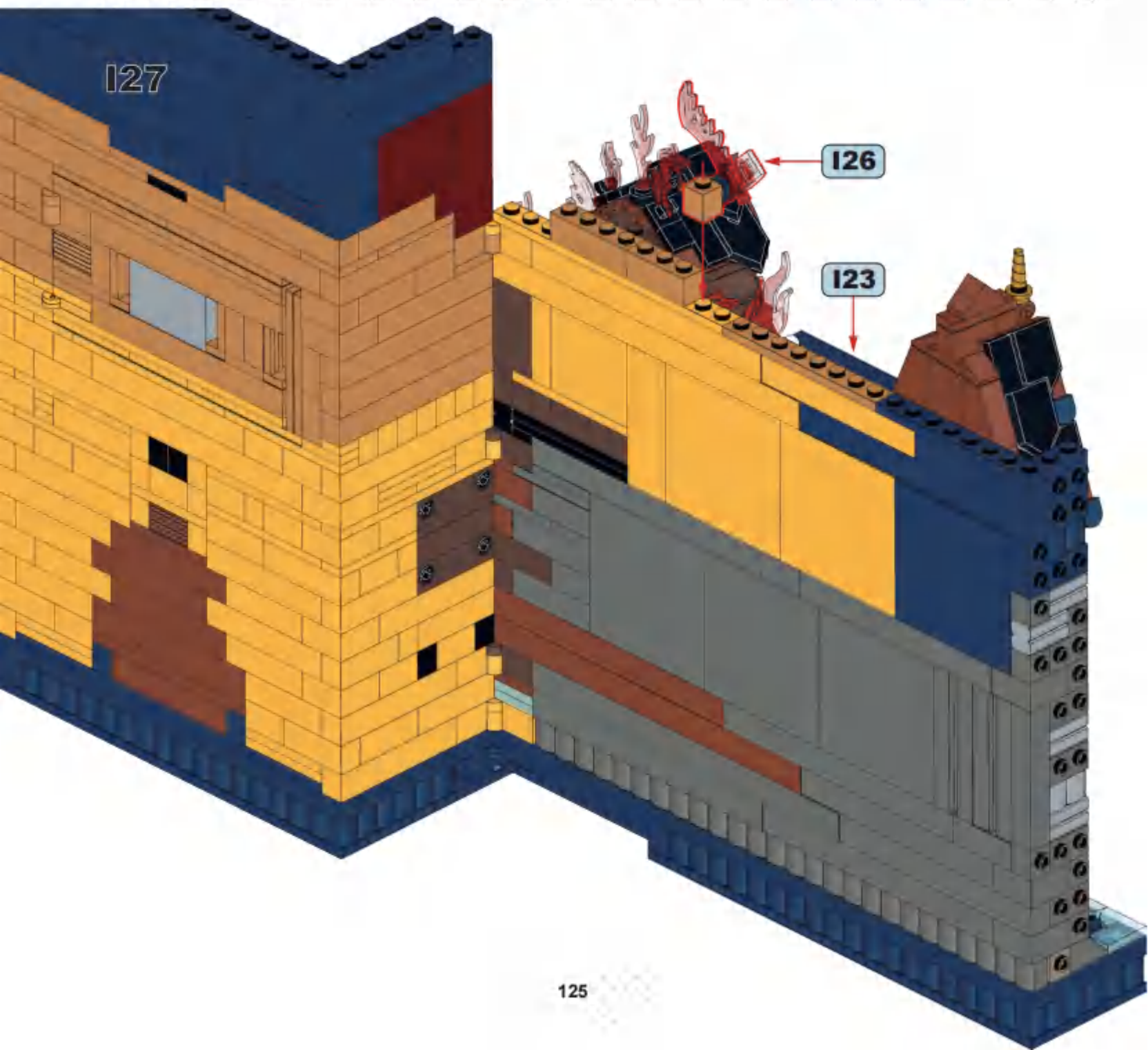
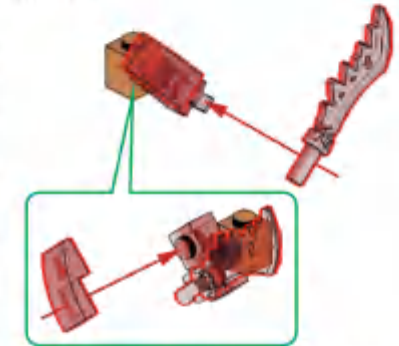



1x

1x8

128

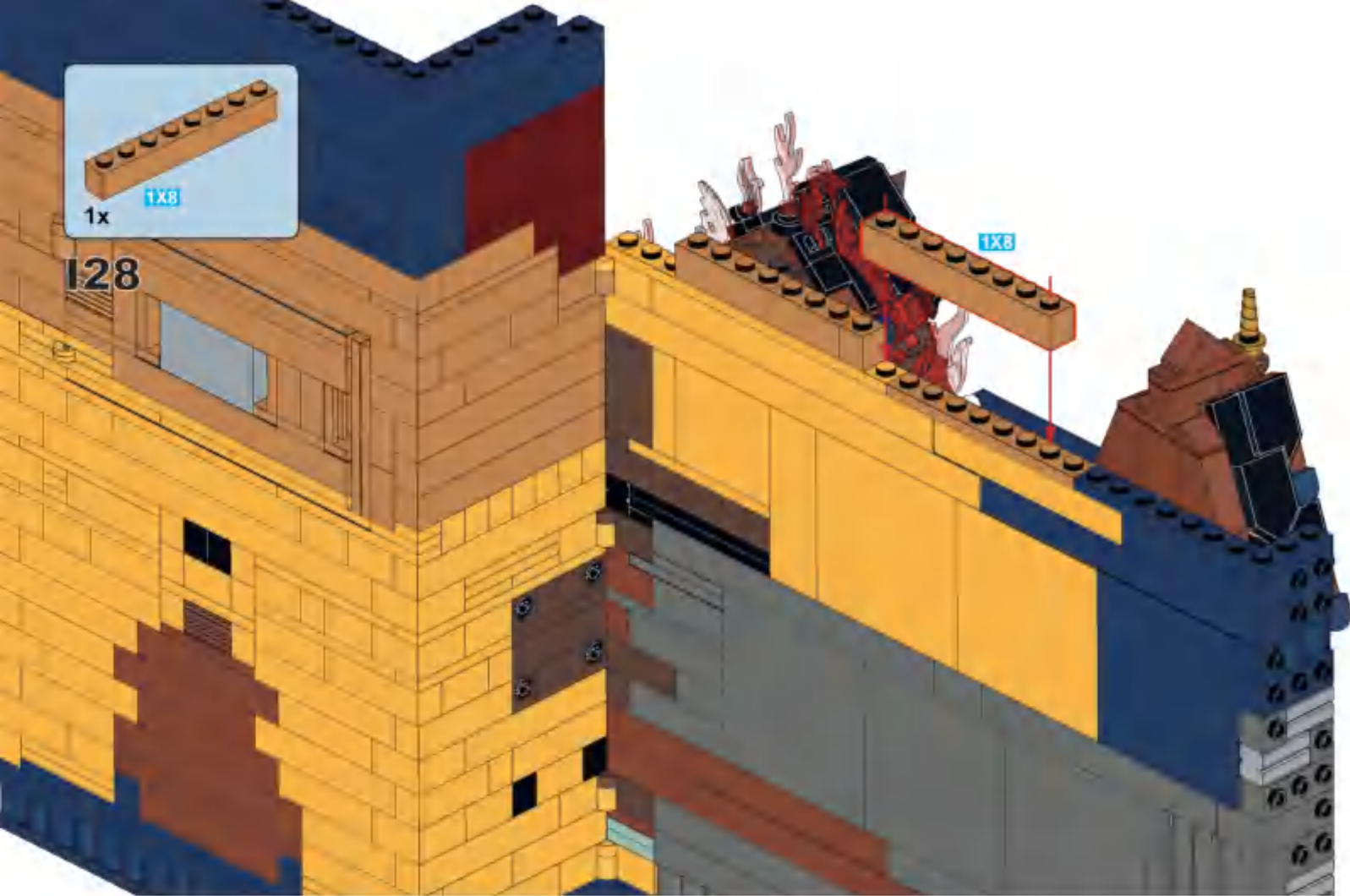

1x

1x

129

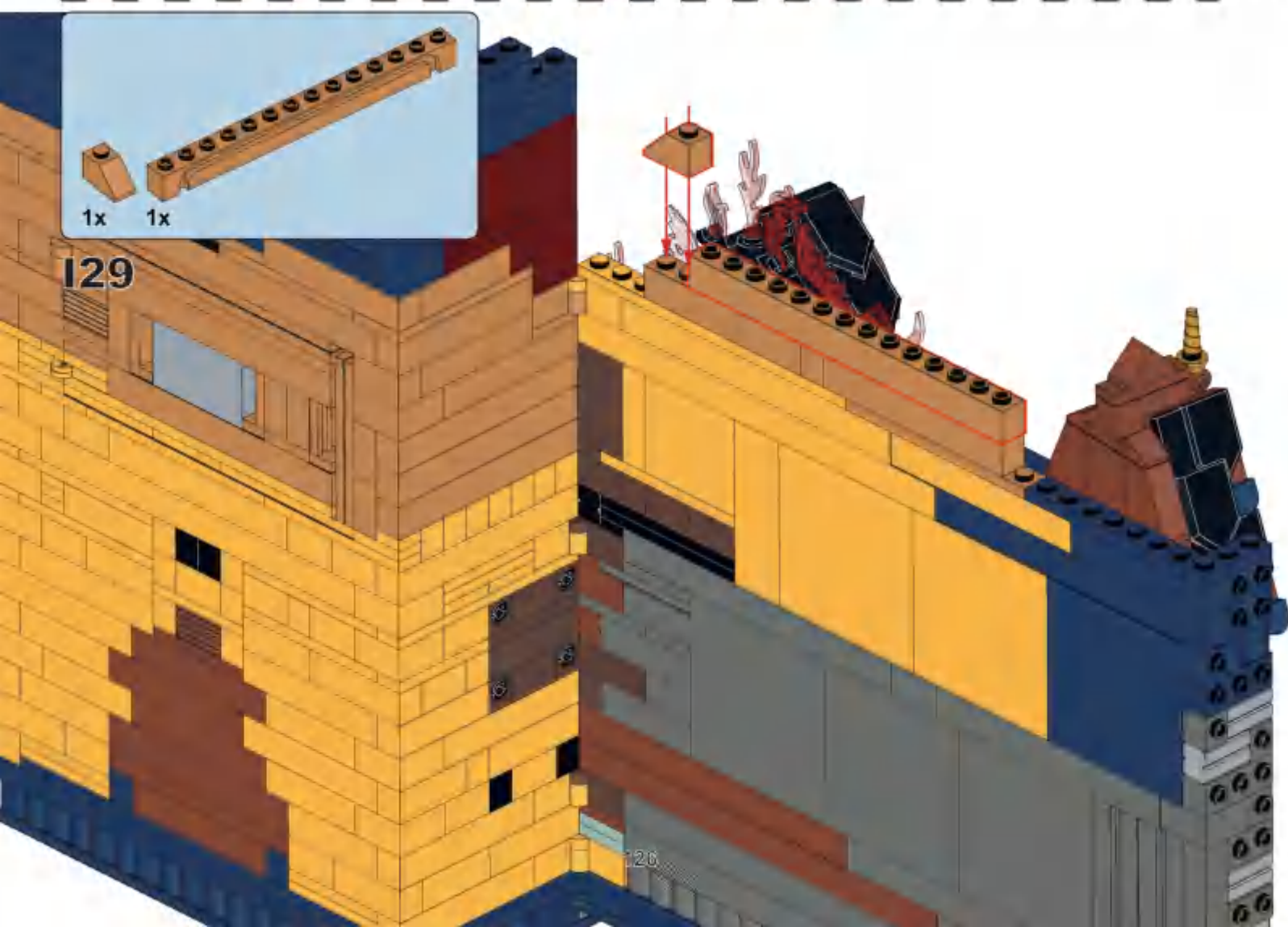

126

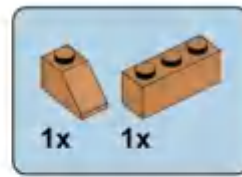
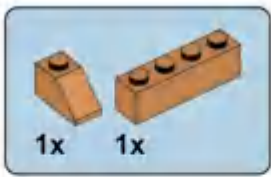

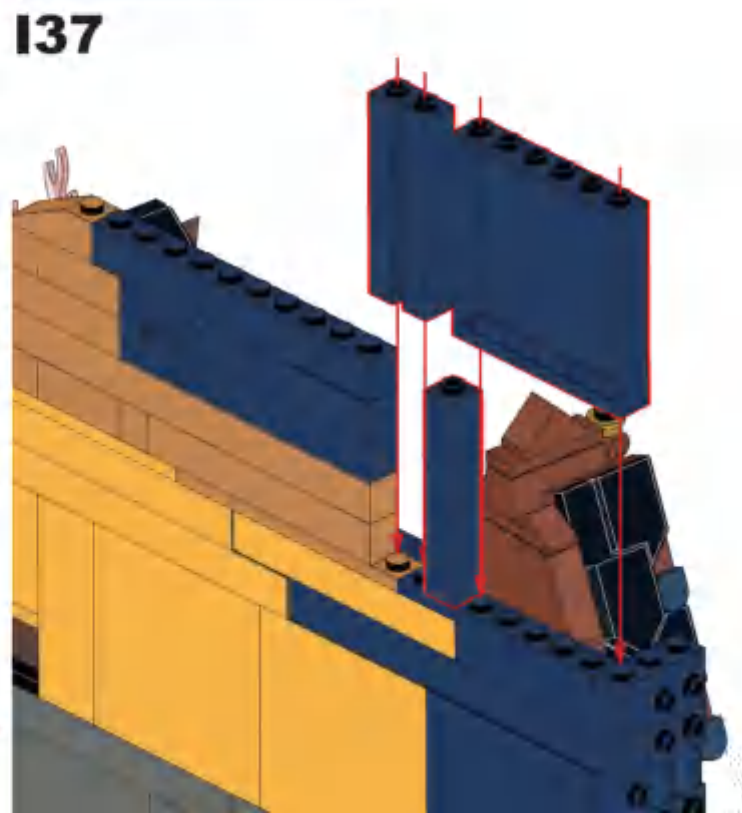
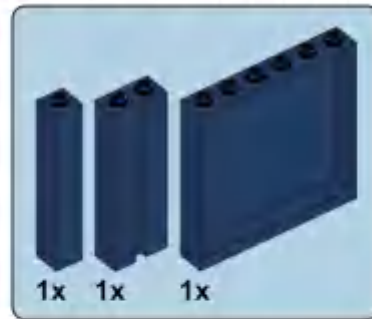
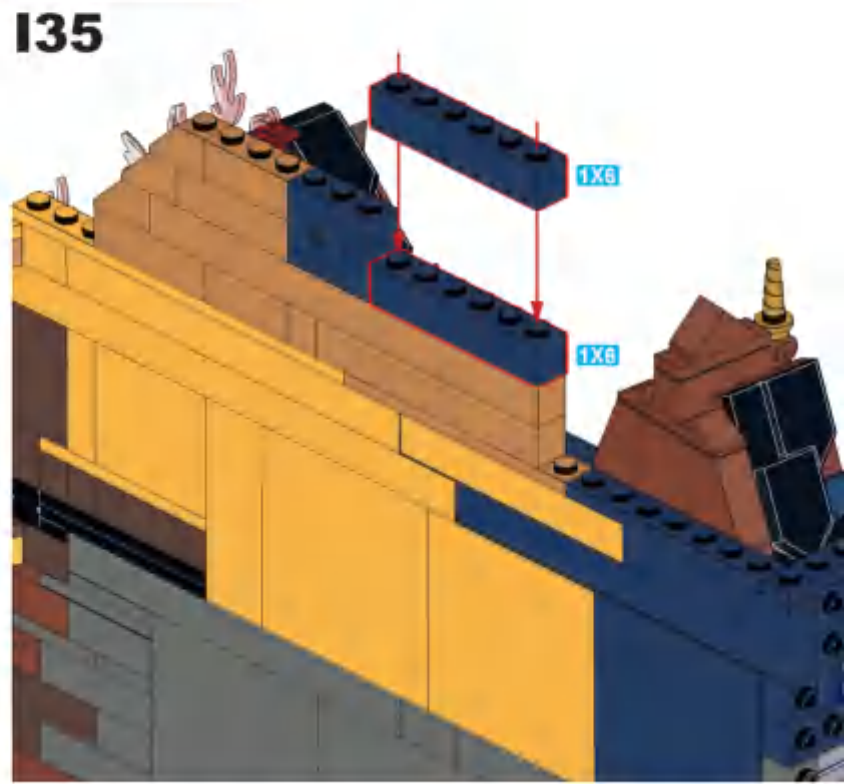

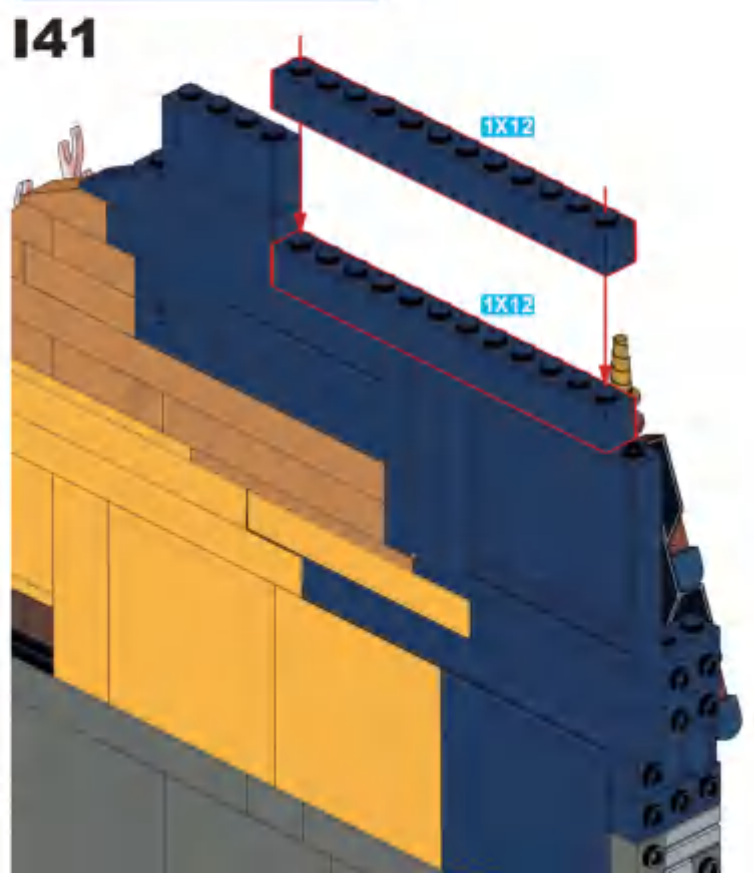
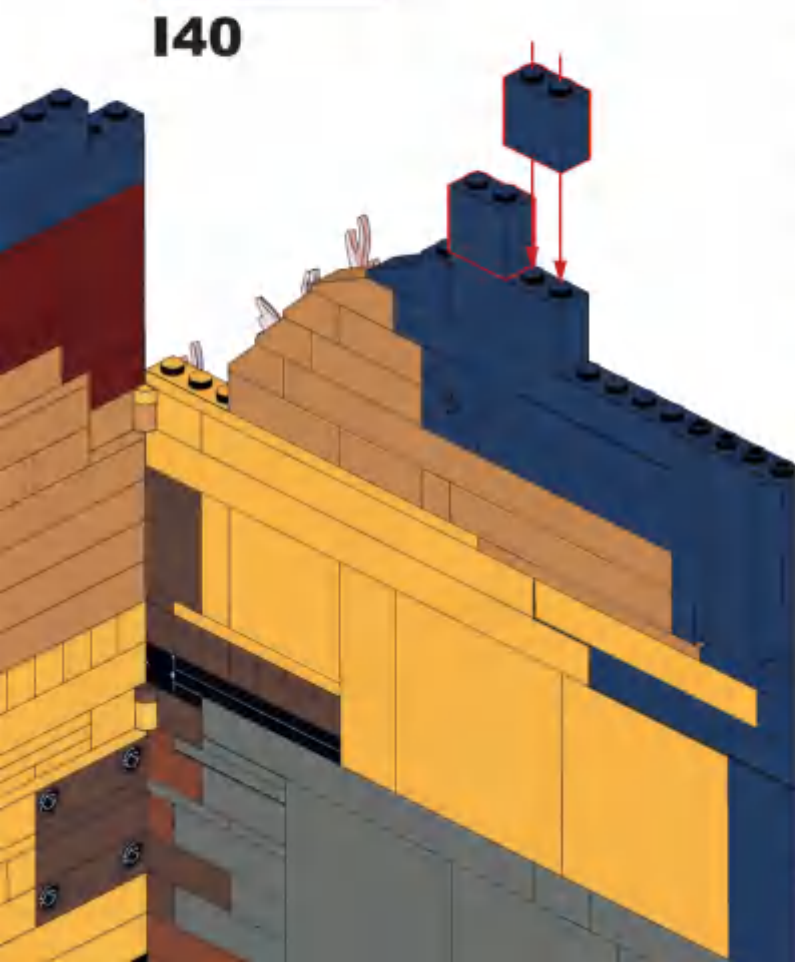
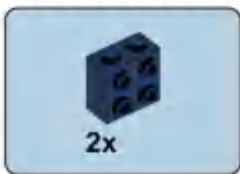
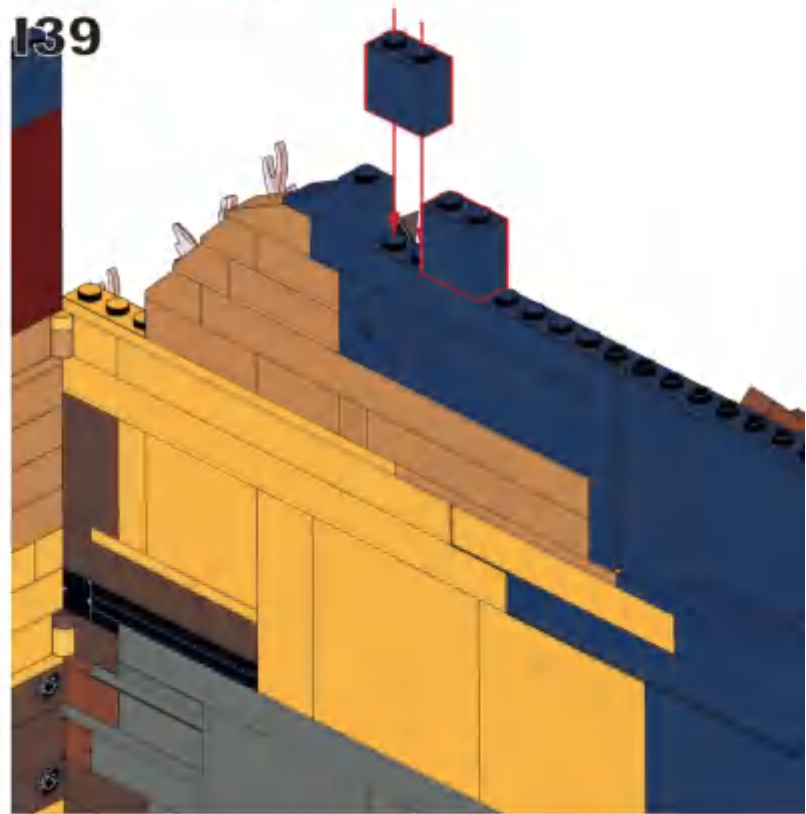



142



143





I44

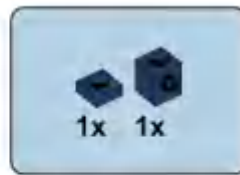
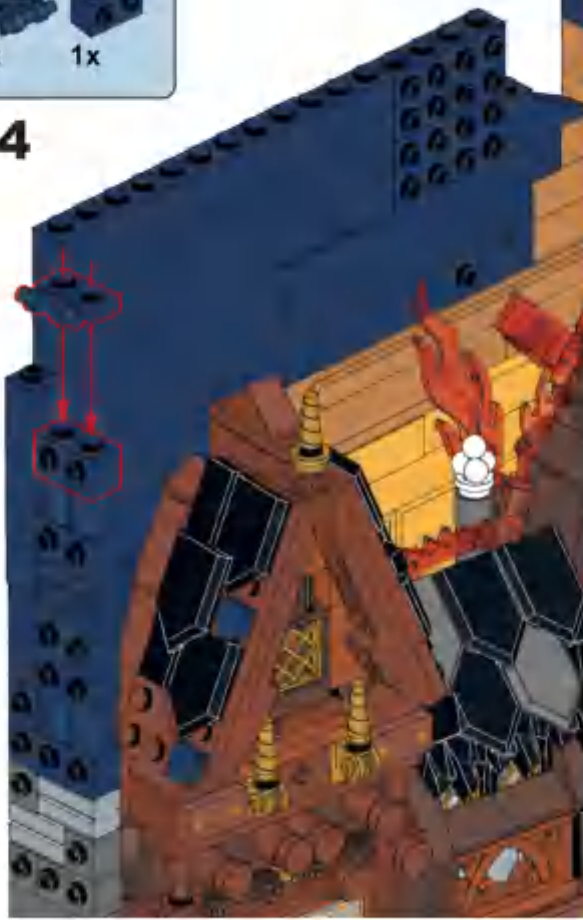

I45



I46



I47





**I48**

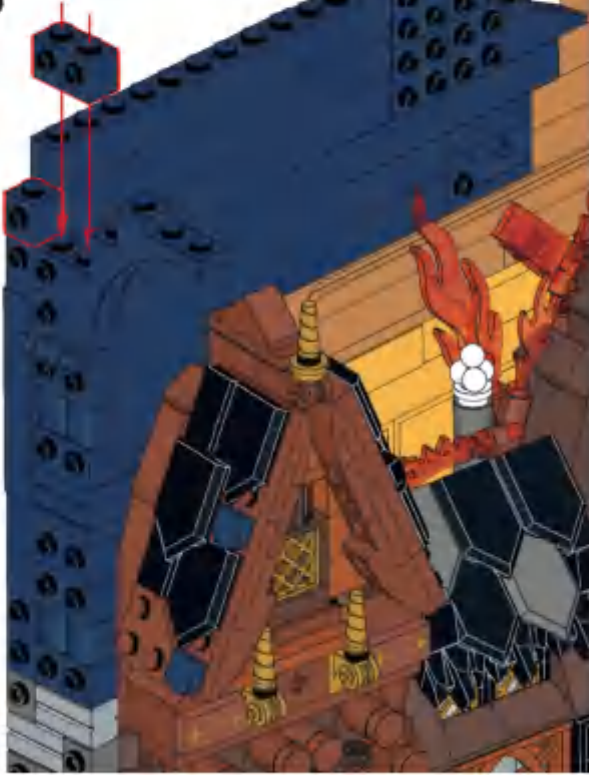

**I49**

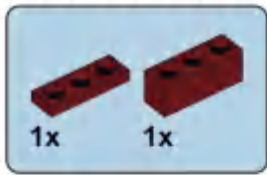
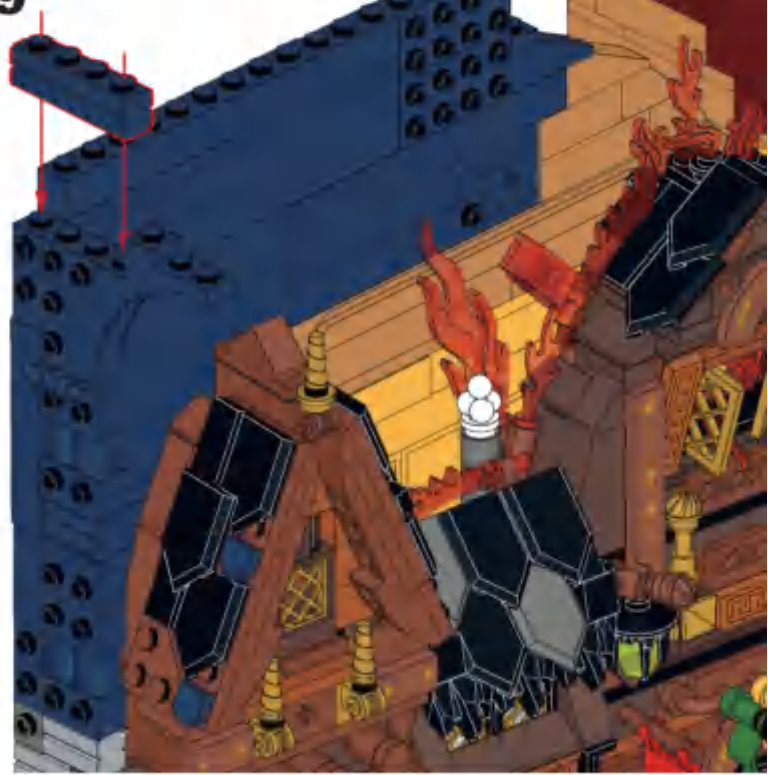

**I50**



**I51**



**I52**





**I53**

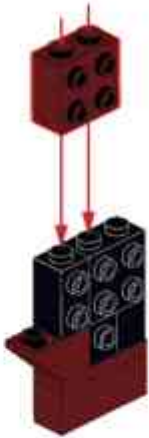

**I54**



**I55**

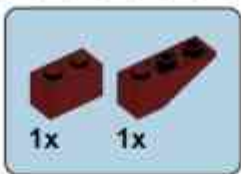

**I56**

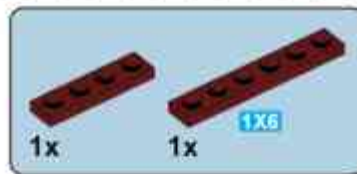

**I57**

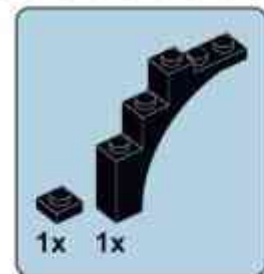
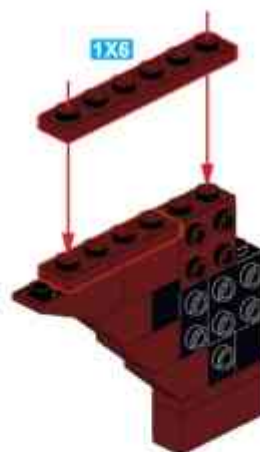

**I58**



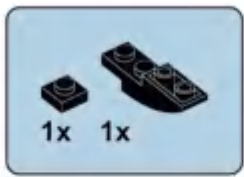

**159**

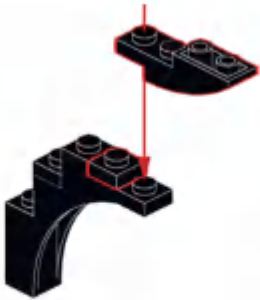

**160**

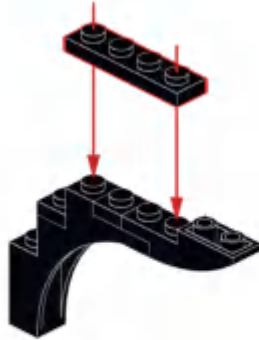

**161**

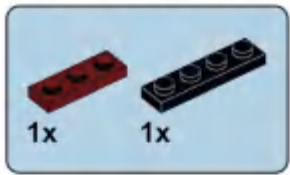
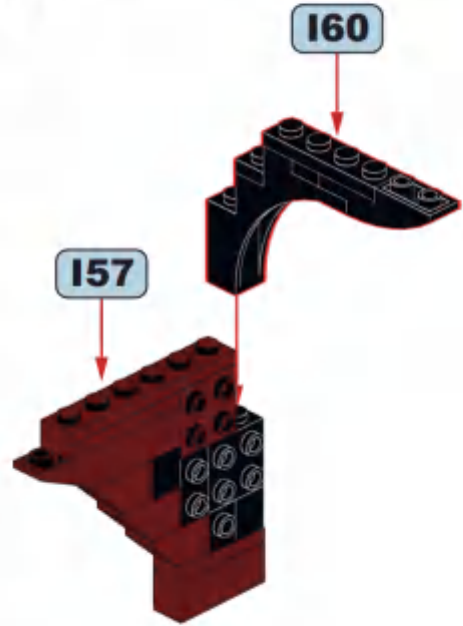

**162**



**163**

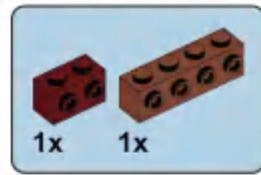

**164**

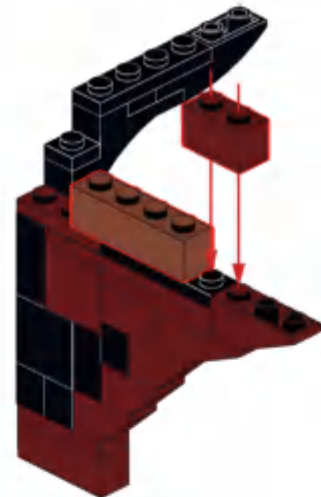

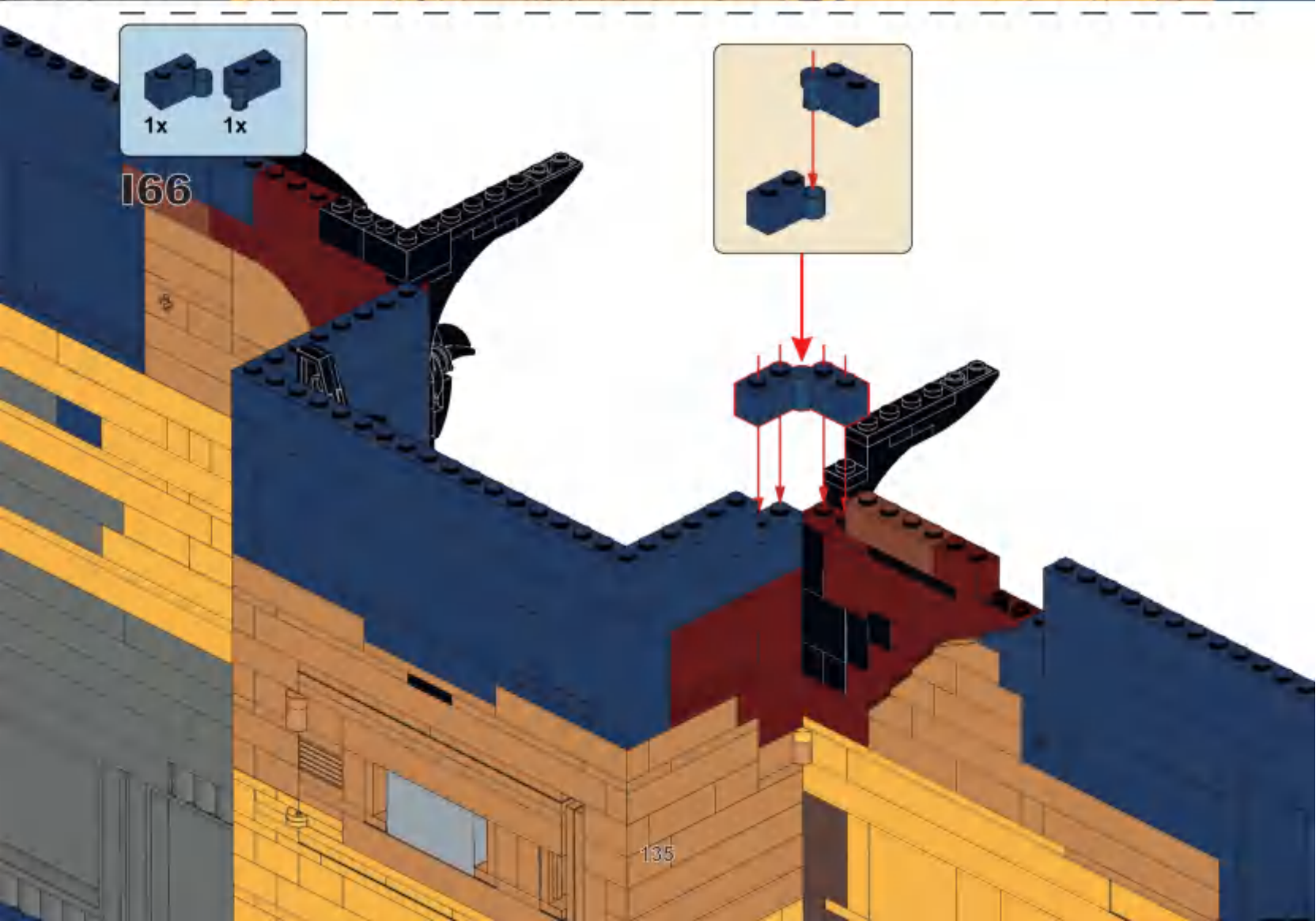
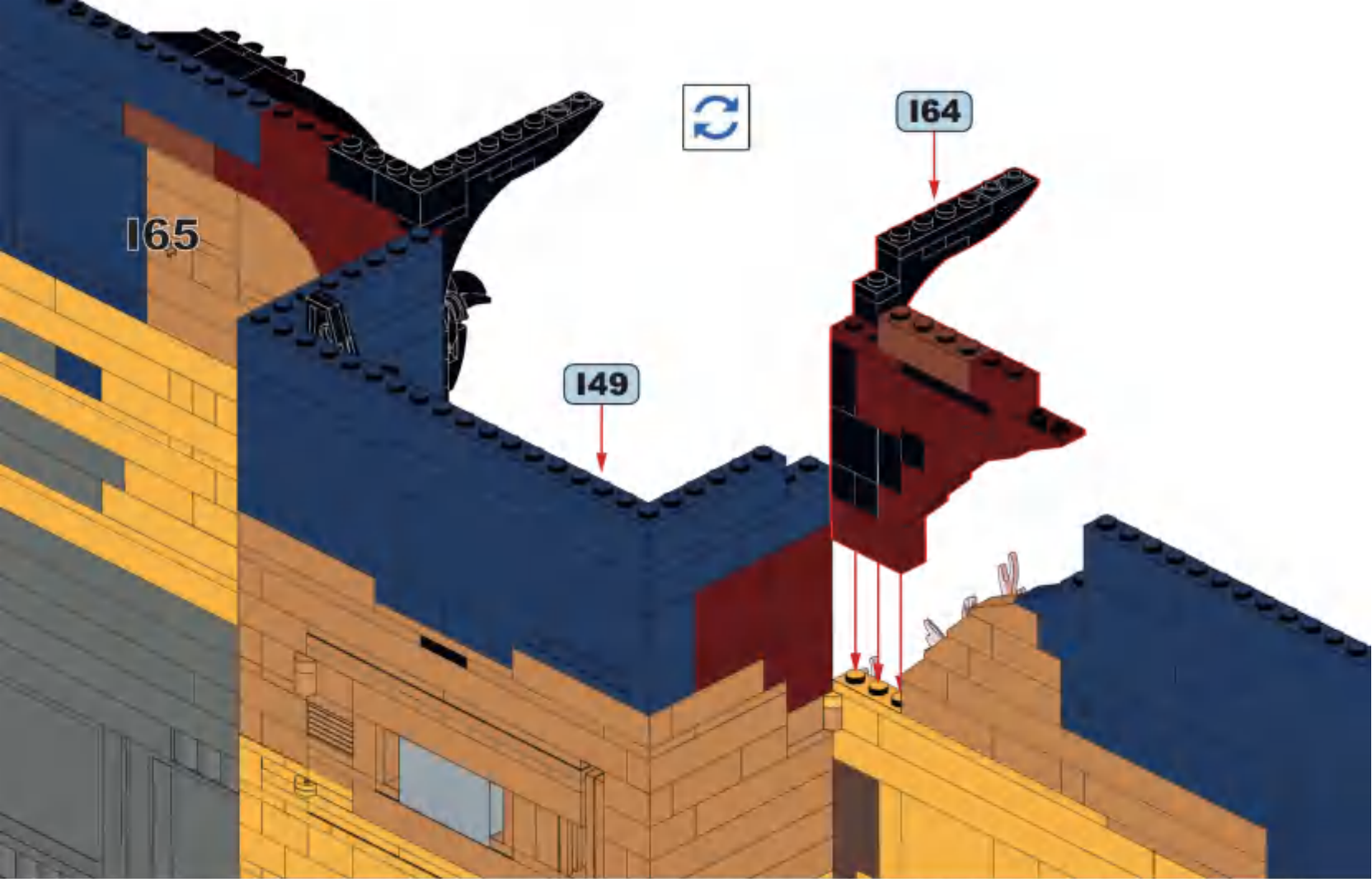

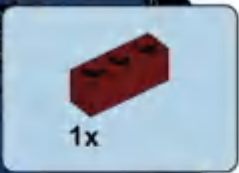

1x

167

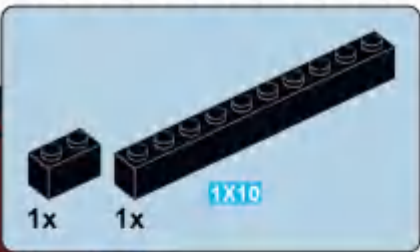
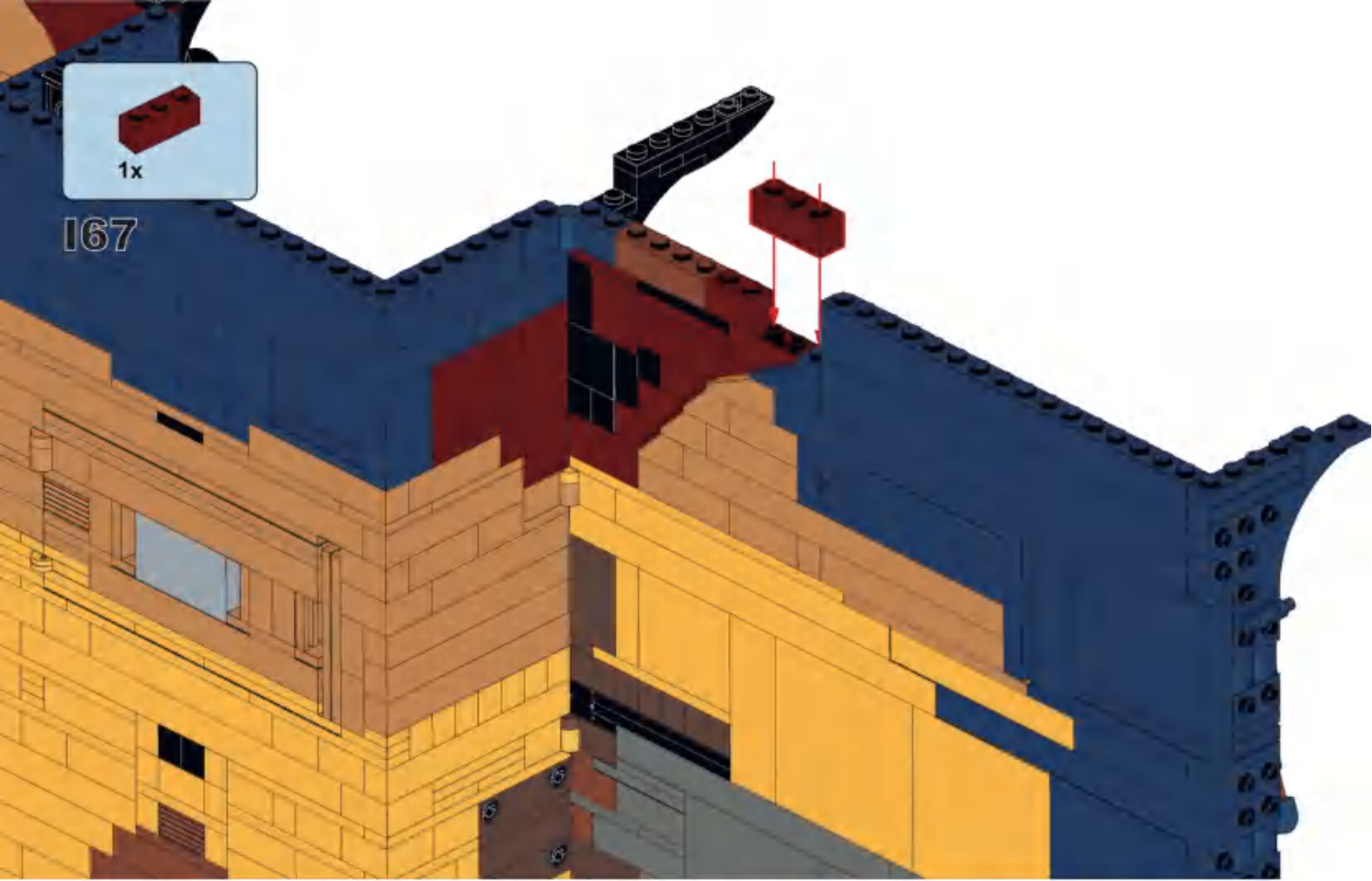

1x

1x

1x10

168

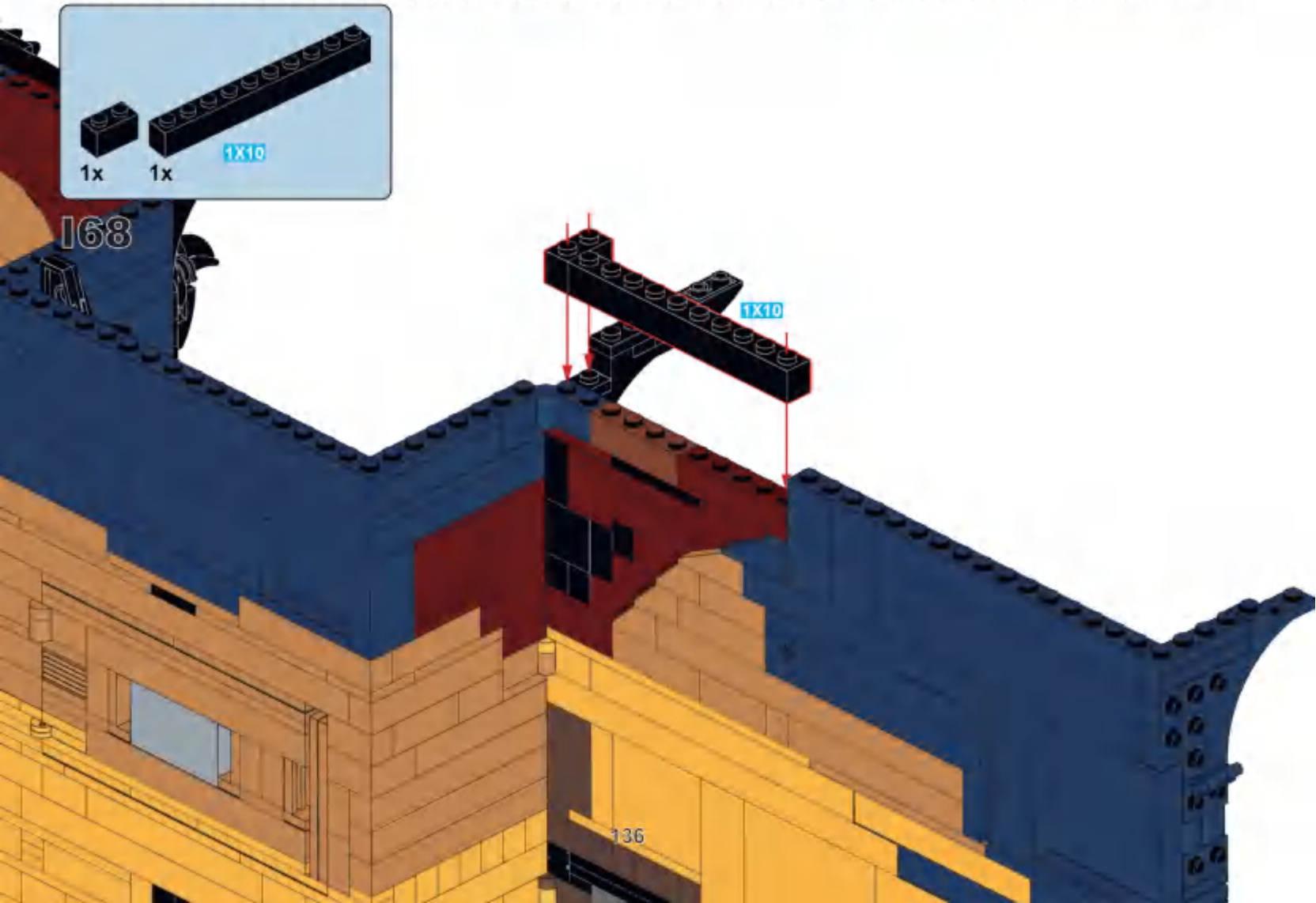

136



**169**

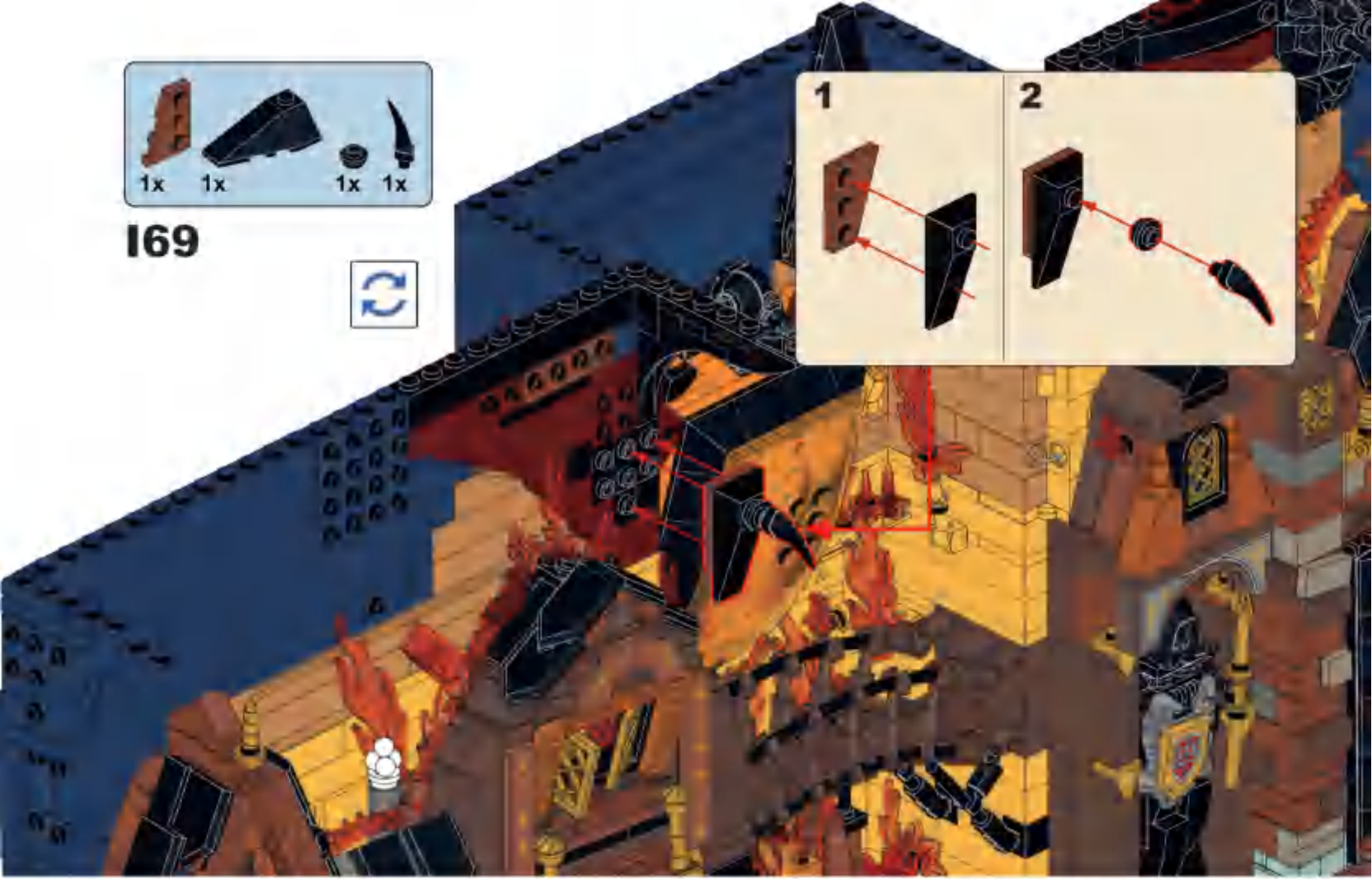
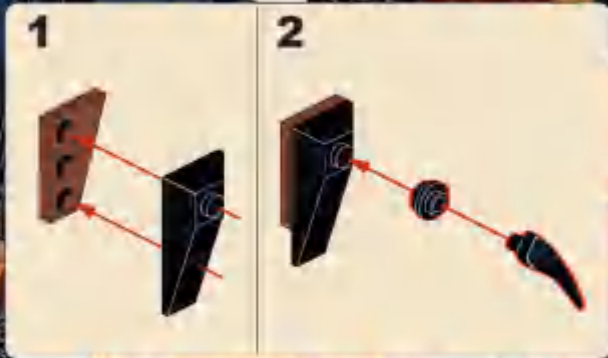

**170**

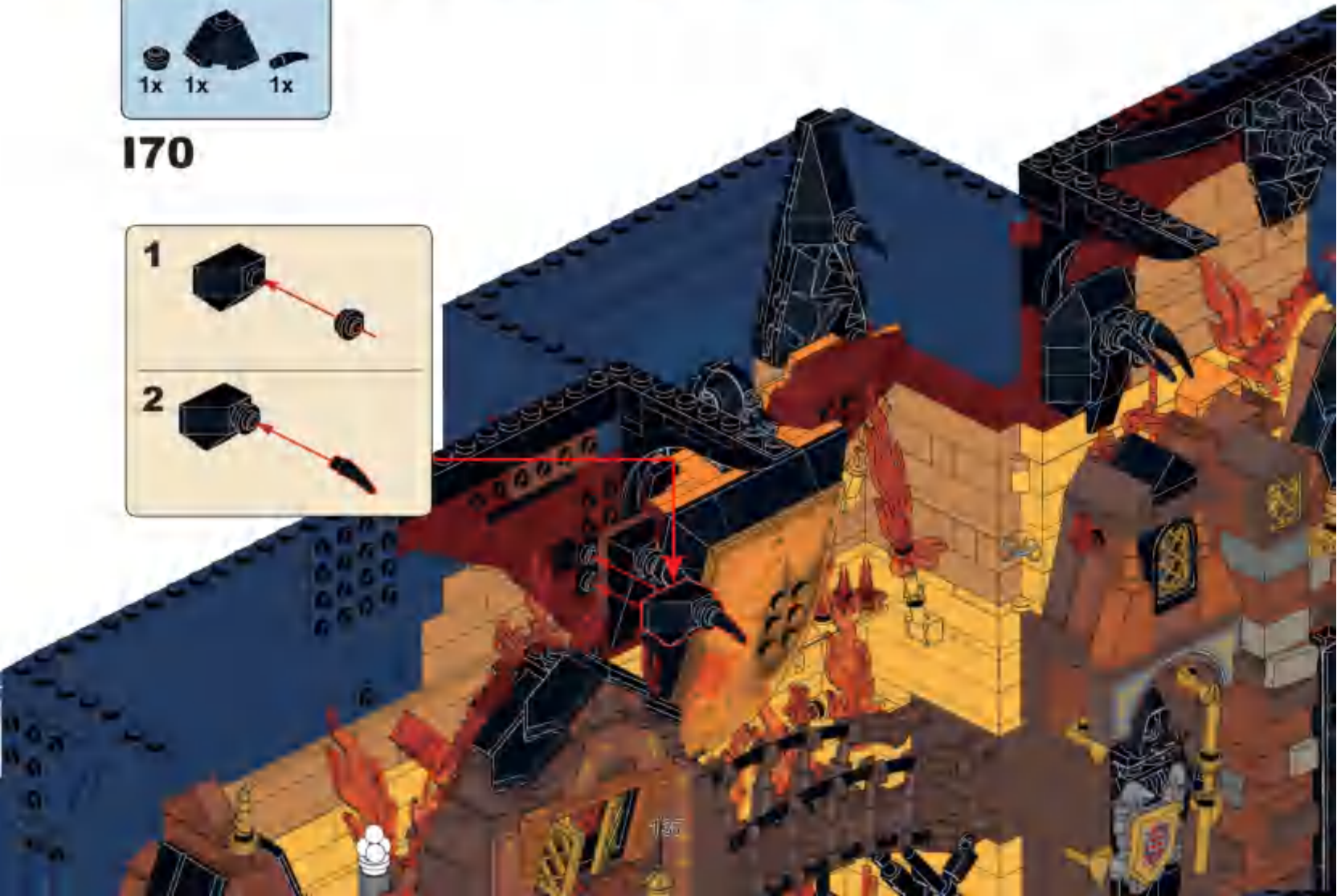



171



172

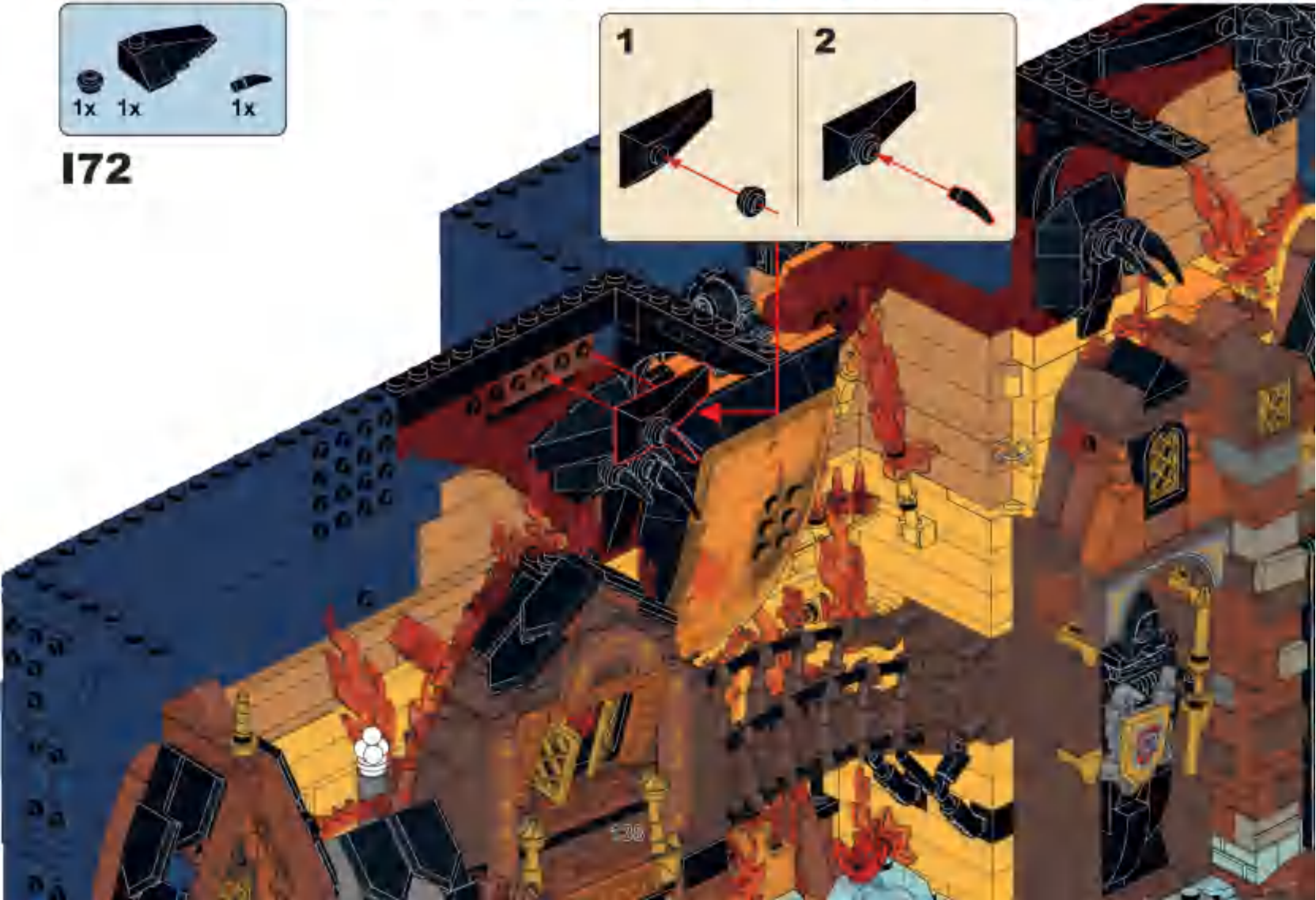
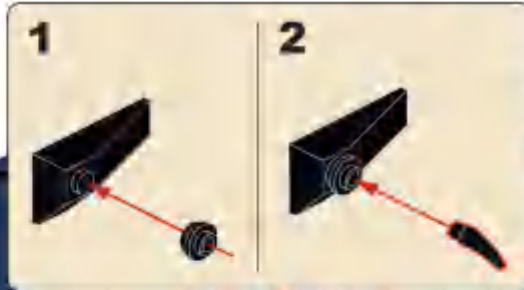



**173**

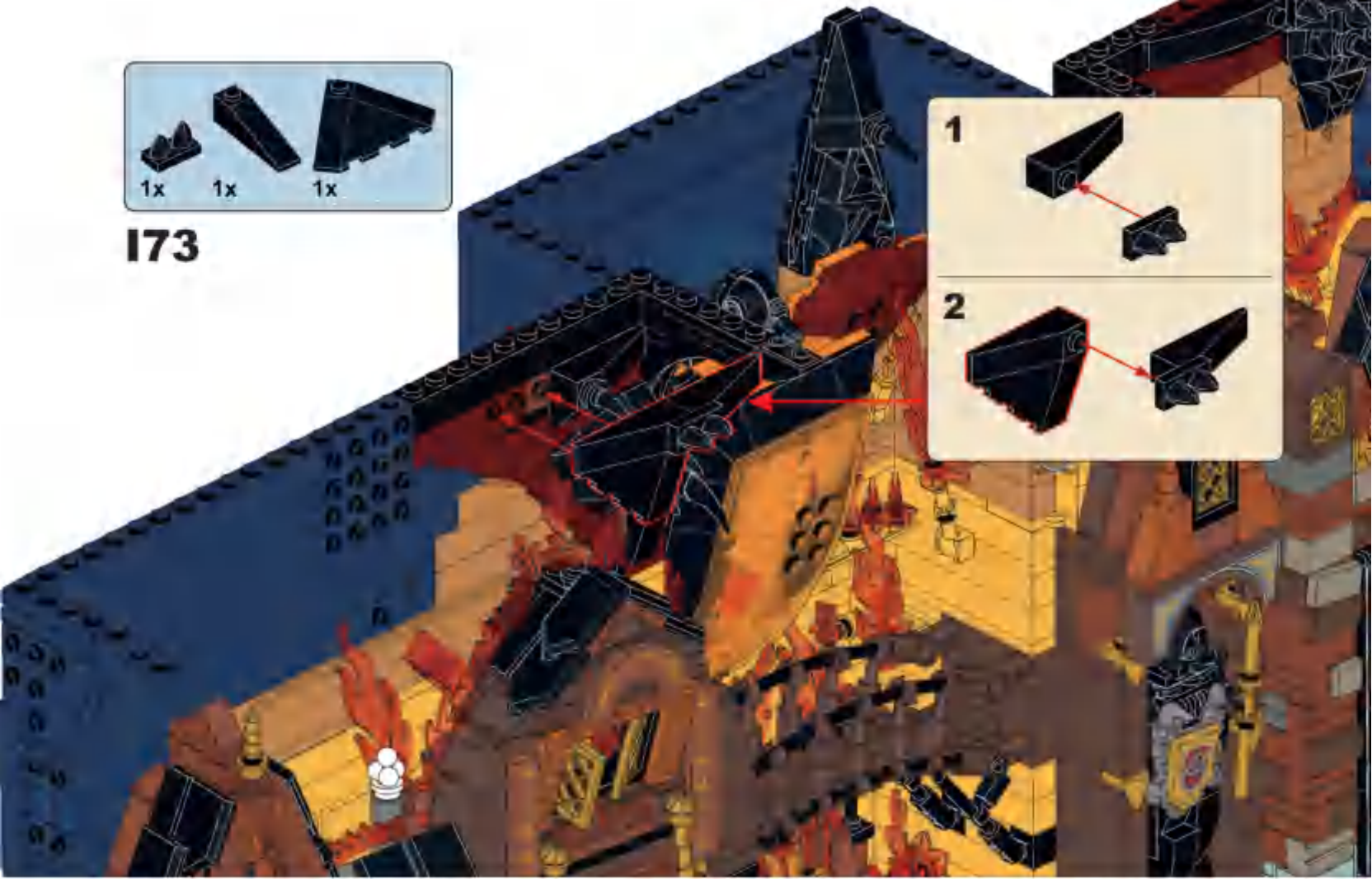

**174**

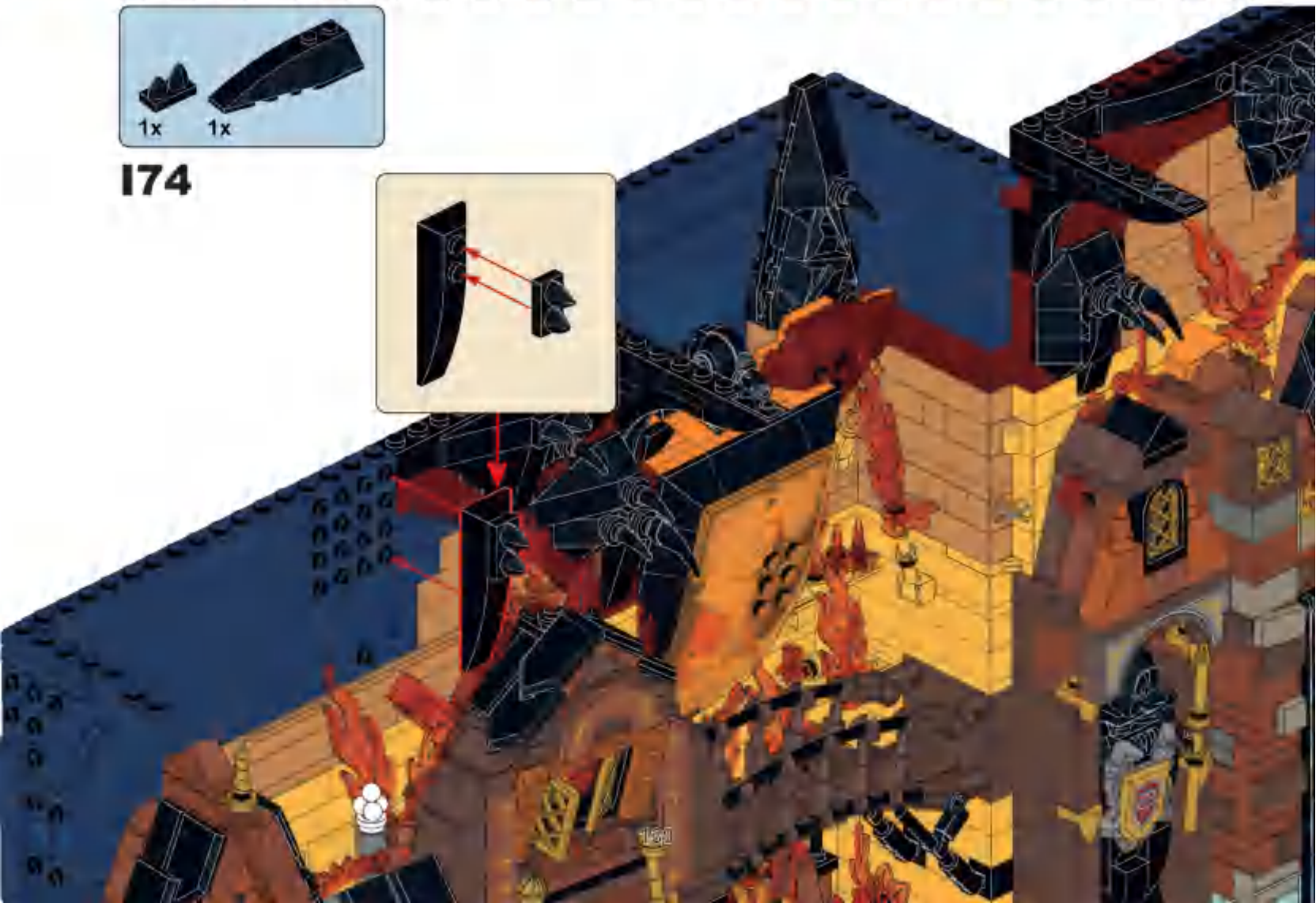
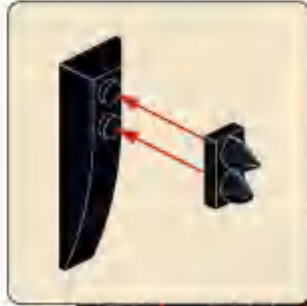



**175**

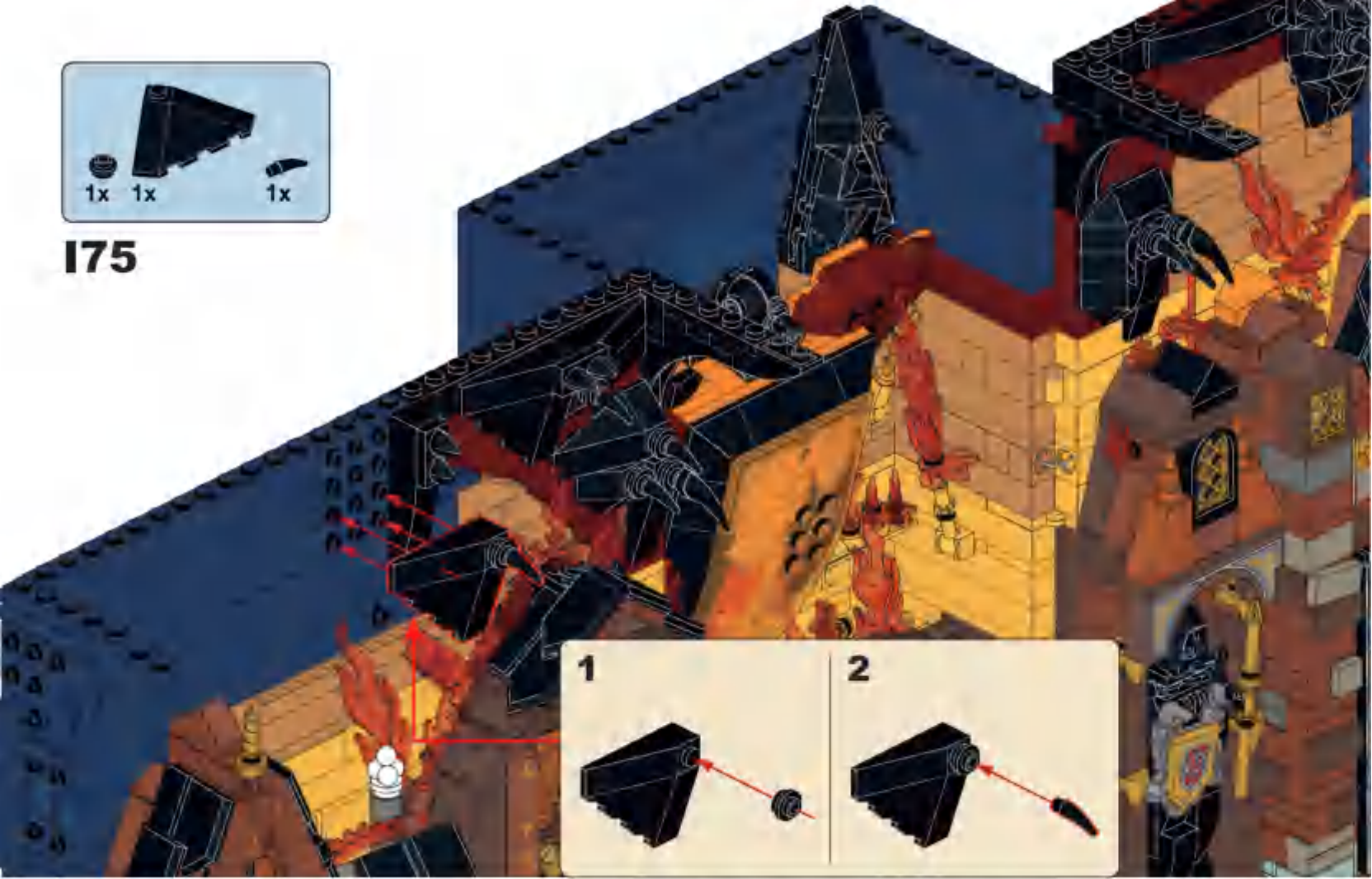

**176**

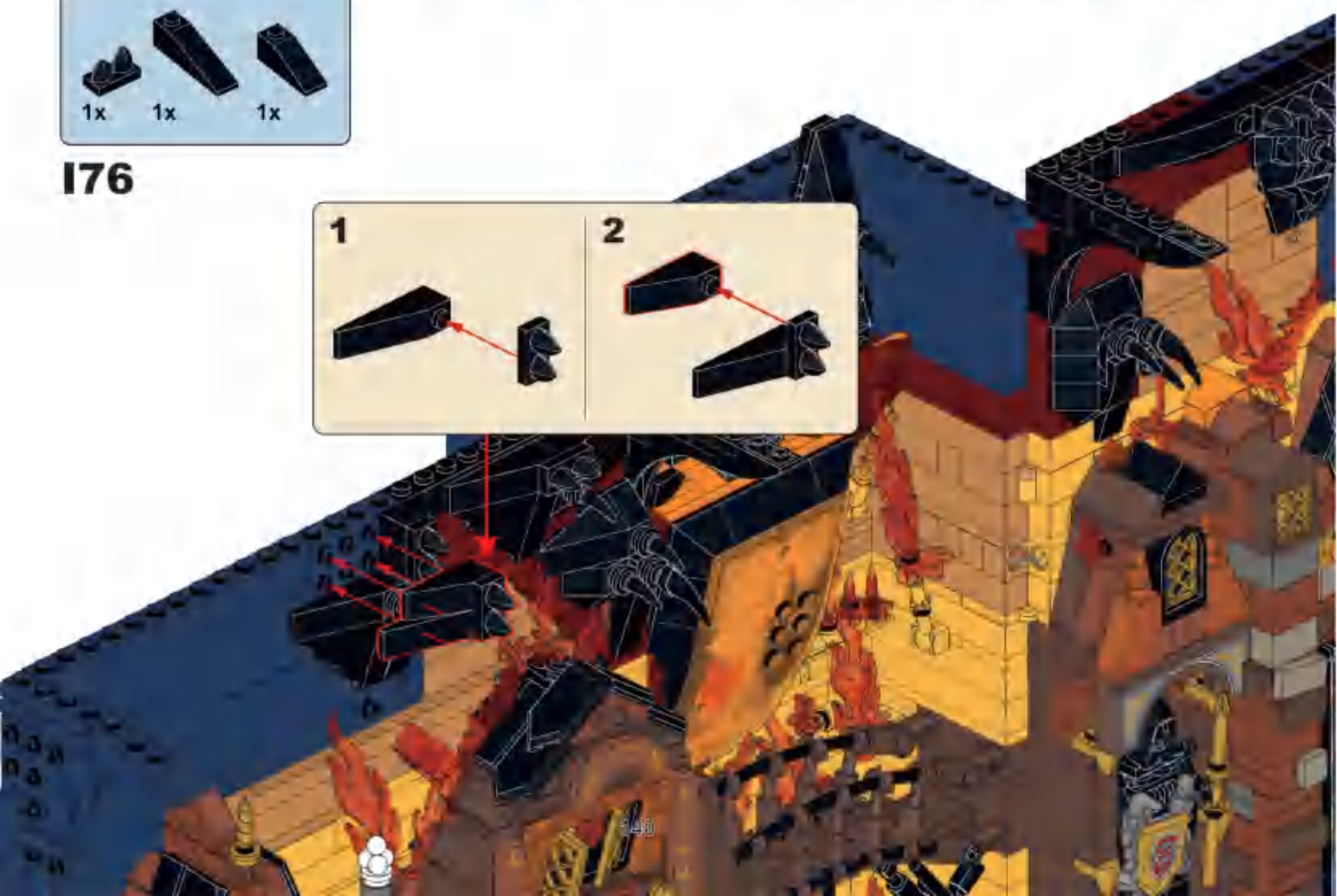



**177**



**178**

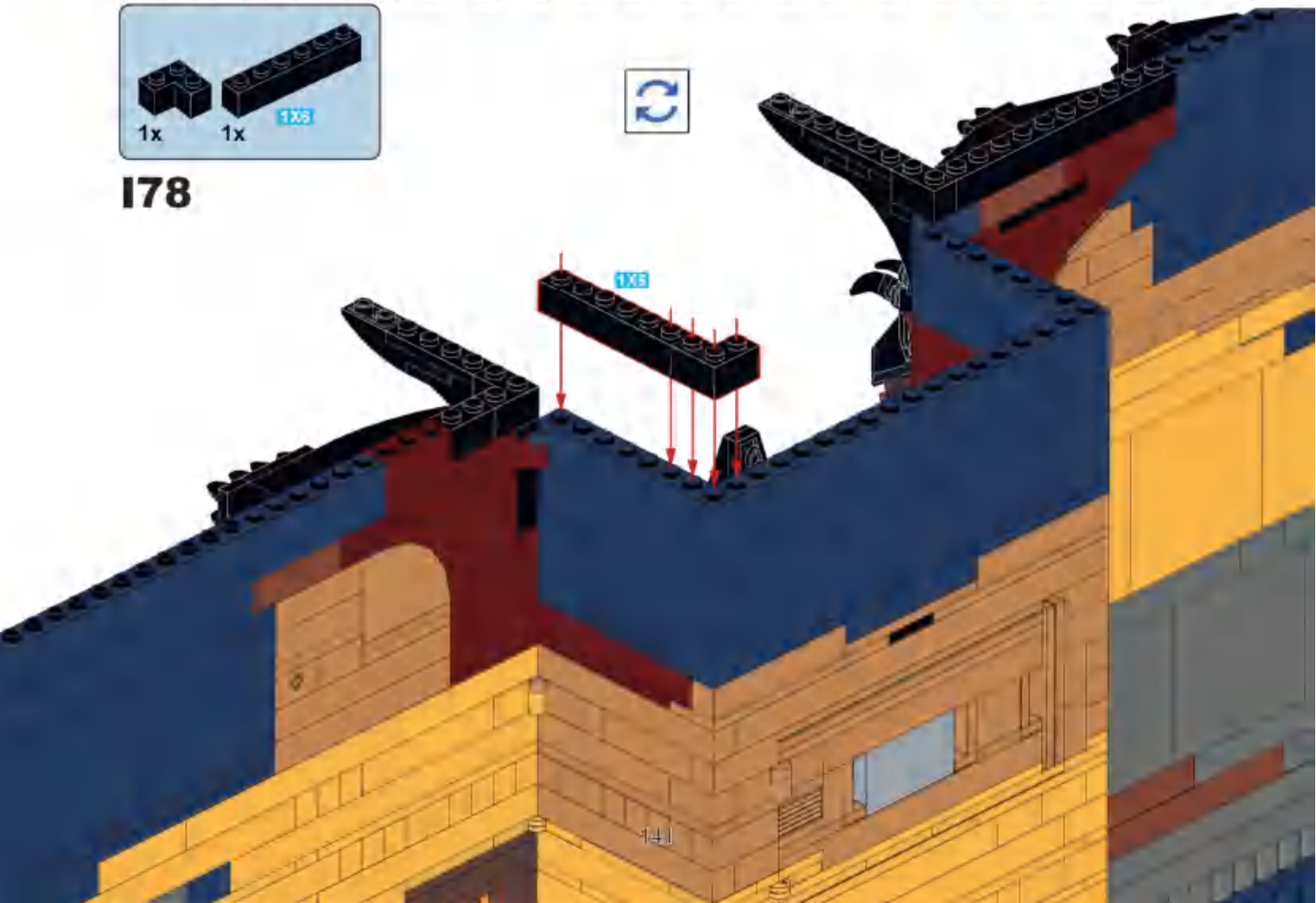

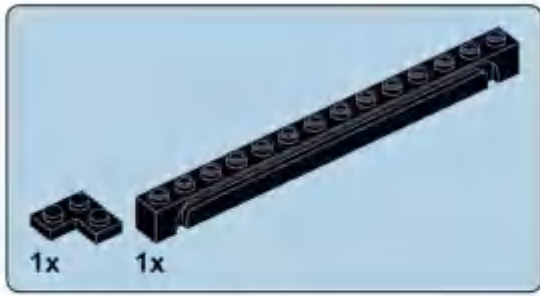

**179**

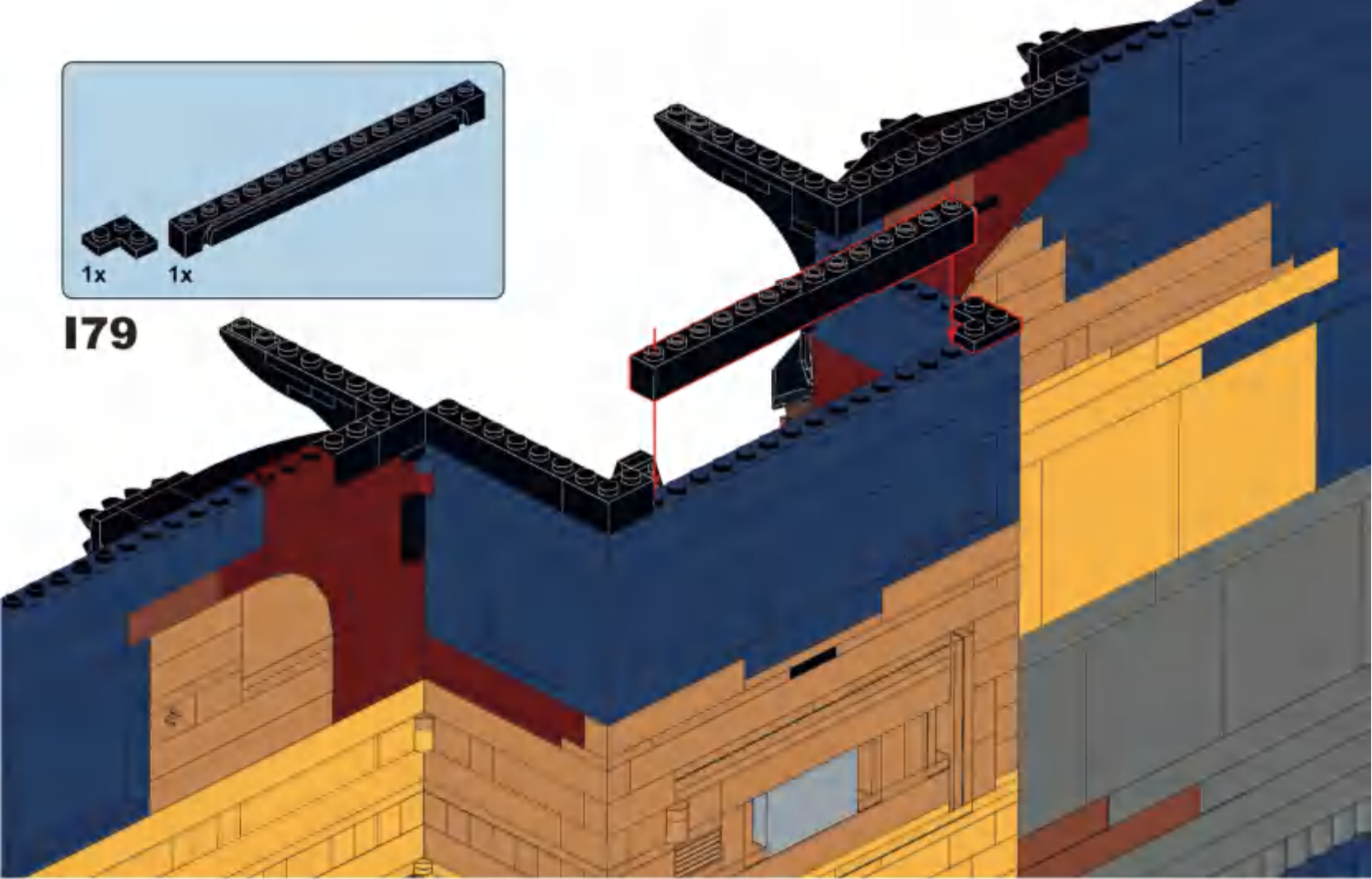

**180**

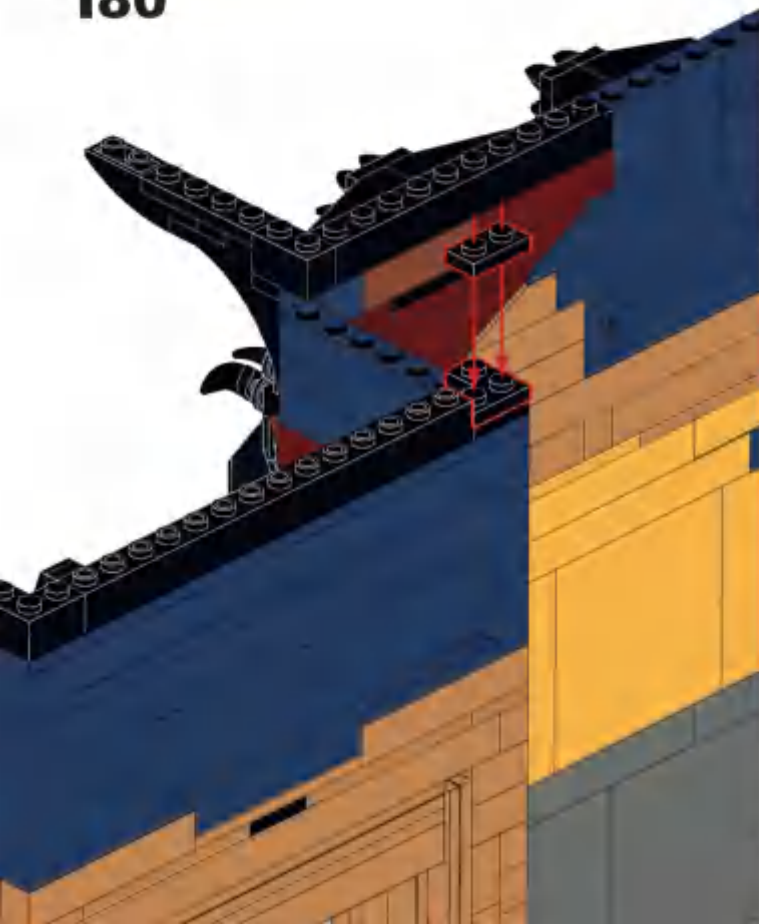

**181**

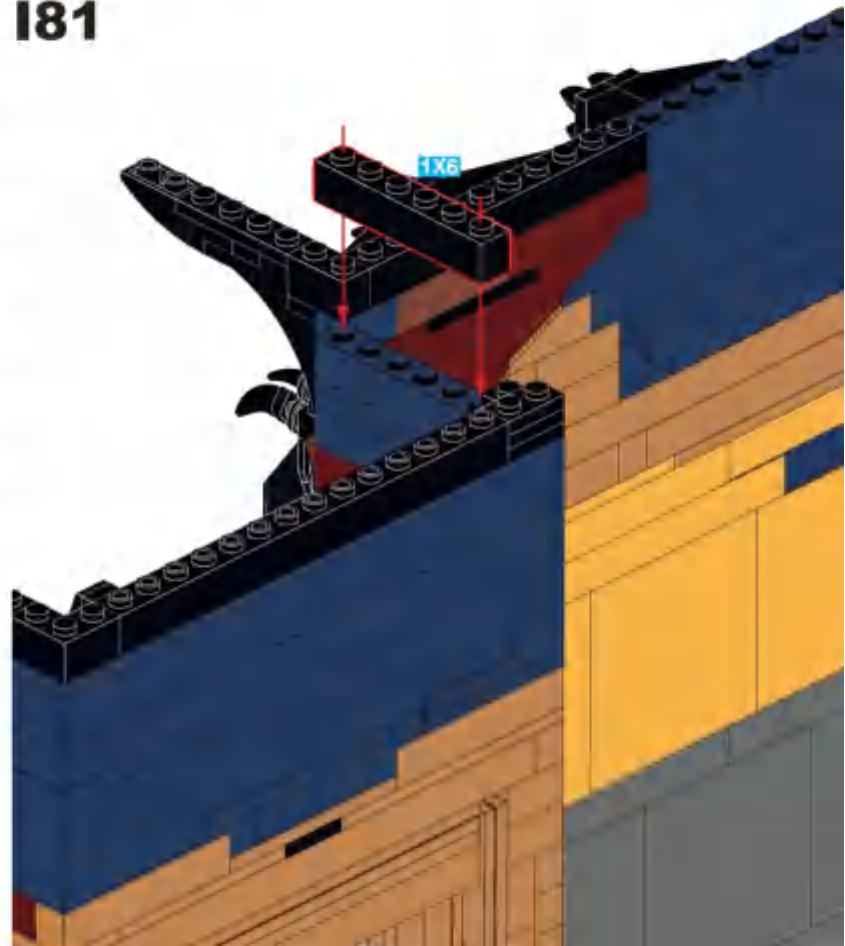

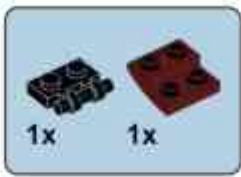

**182**

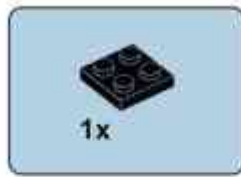

**183**

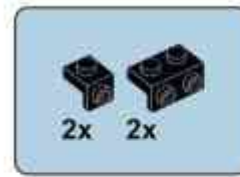

**184**

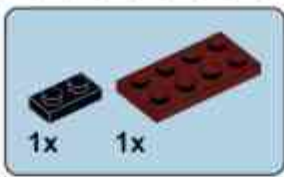
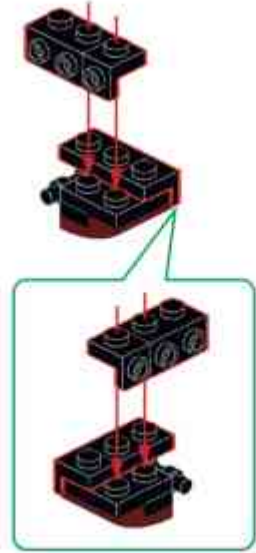

**185**



**186**

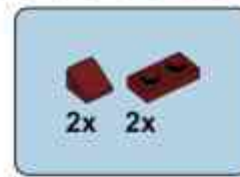

**187**

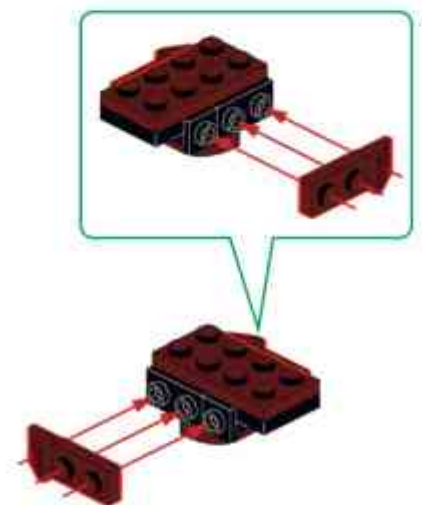



**188**

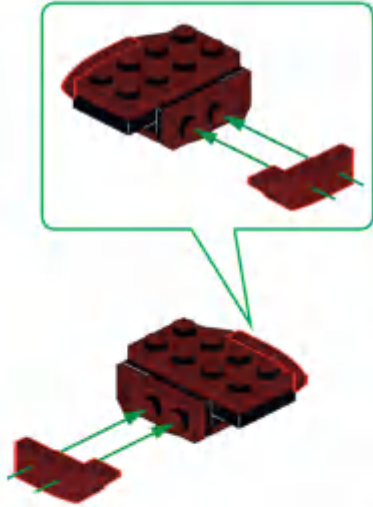

**189**

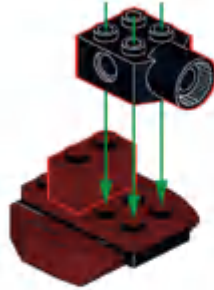

**190**

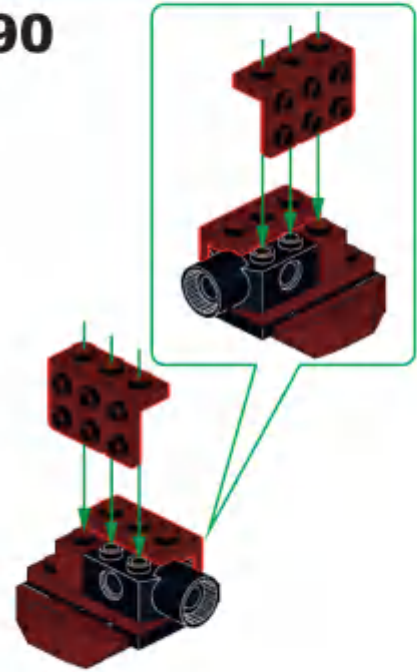

**191**



**192**

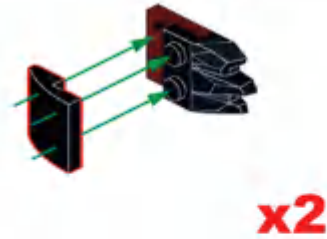

**193**

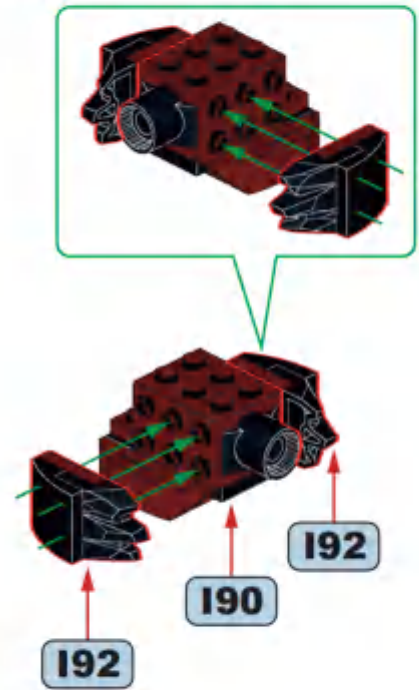



**194**

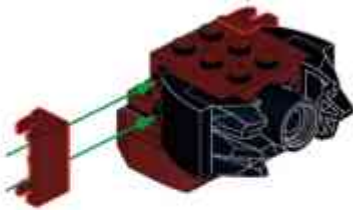
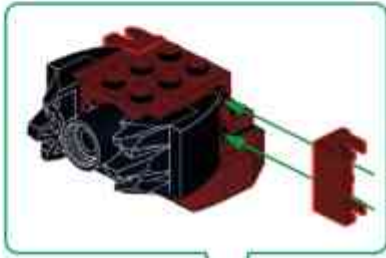

**195**

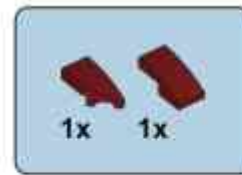
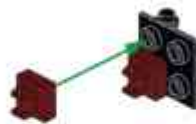

**196**

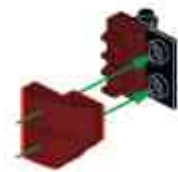

**197**

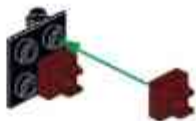

**198**

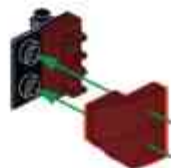

**199**

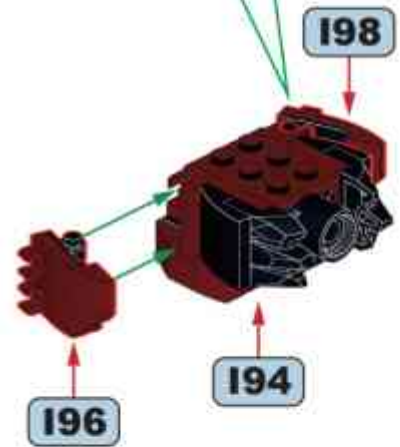
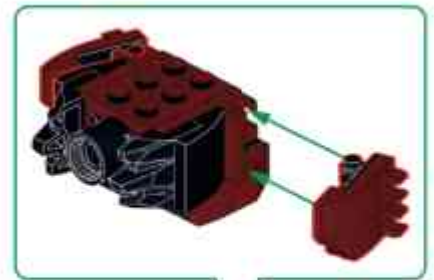



**I100**

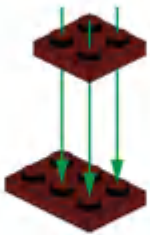

**I101**

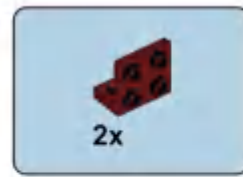
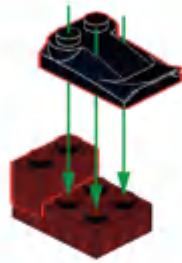

**I102**

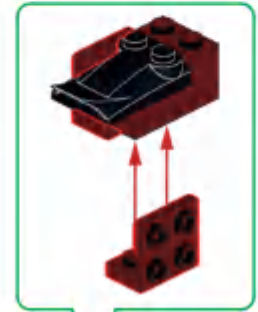

**I103**

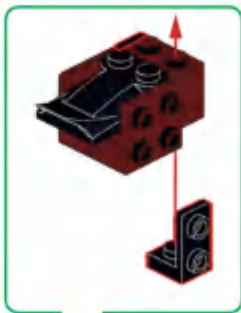

**I104**

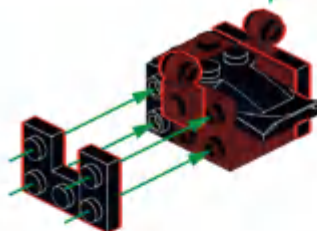
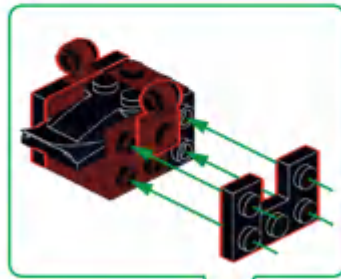

**I105**



**x2**

# I106

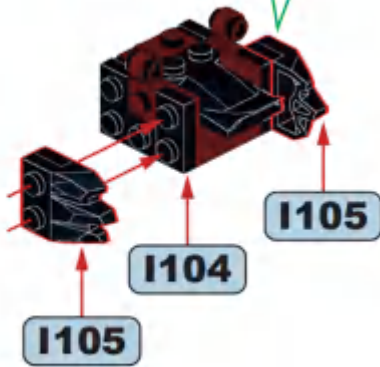
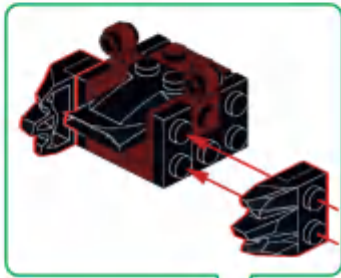

# I107

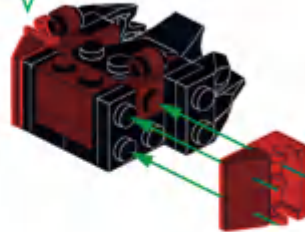
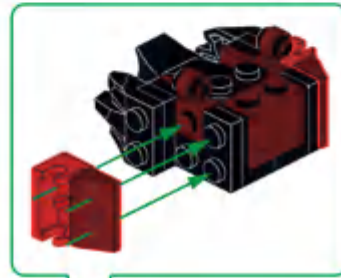

# I108



# I109

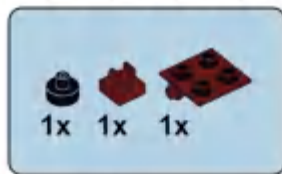

# I110

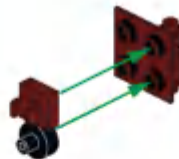

# I111

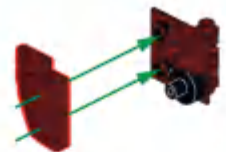

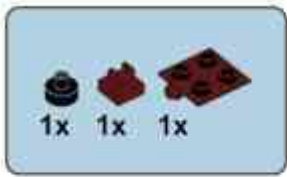

**I112**

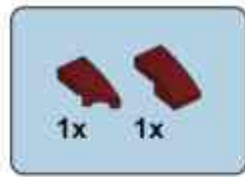
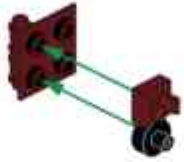

**I113**

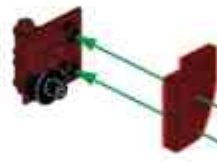

**I114**

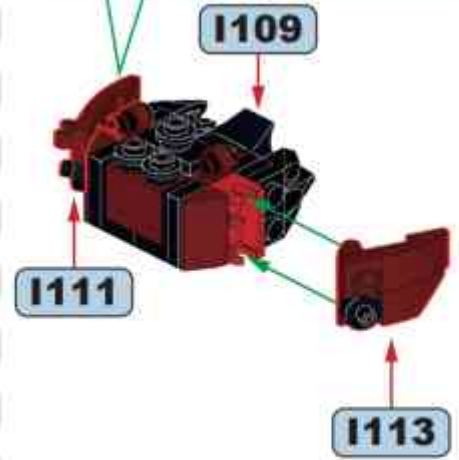
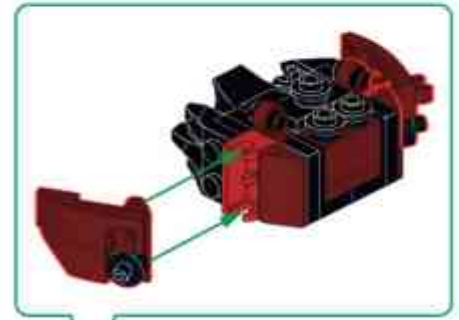

**I115**



**I116**



**I117**



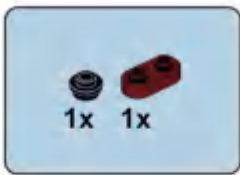

**I118**

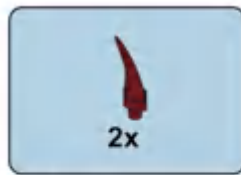
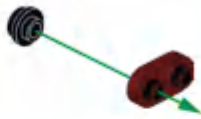

**I119**



**I120**

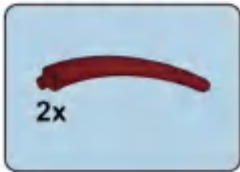
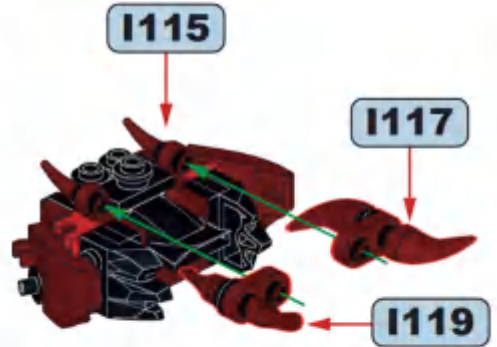

**I121**

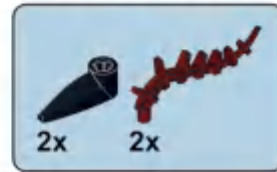

**I122**

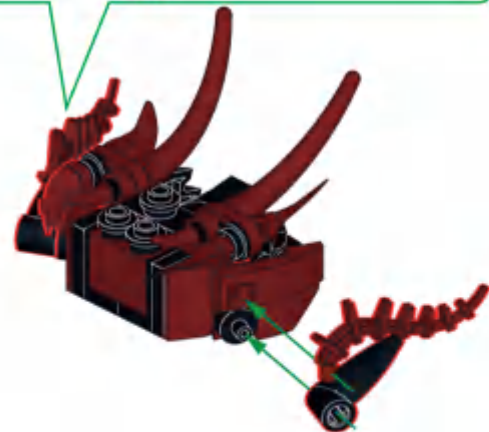
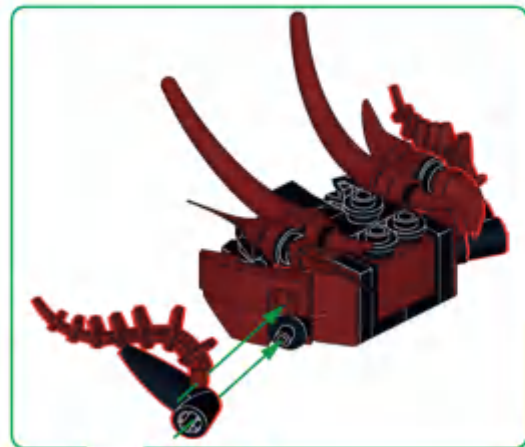

I123

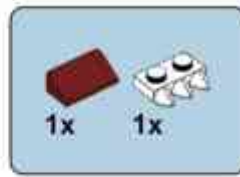

I124



I125

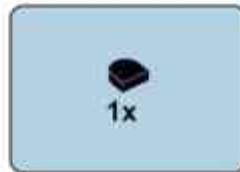

I126





**I127**

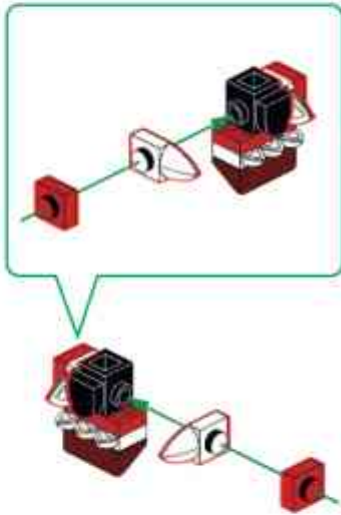

**I128**



**I129**

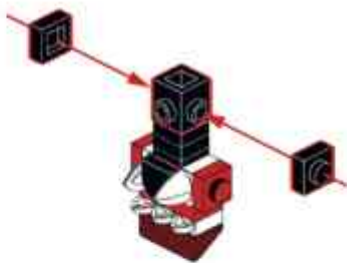

**I130**



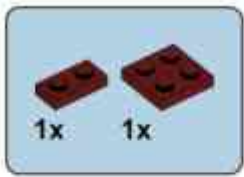

**I131**

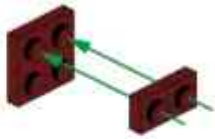

**I132**

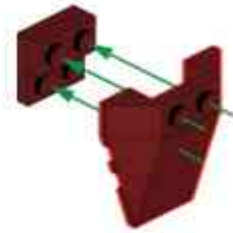

**I133**

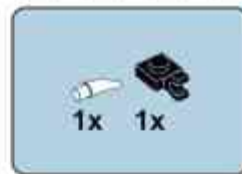
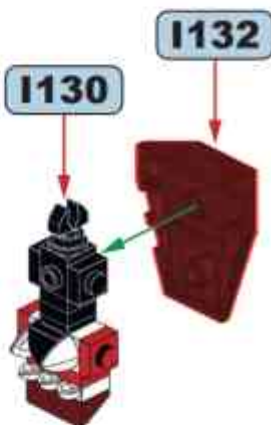

**I134**





**I135**



**I136**

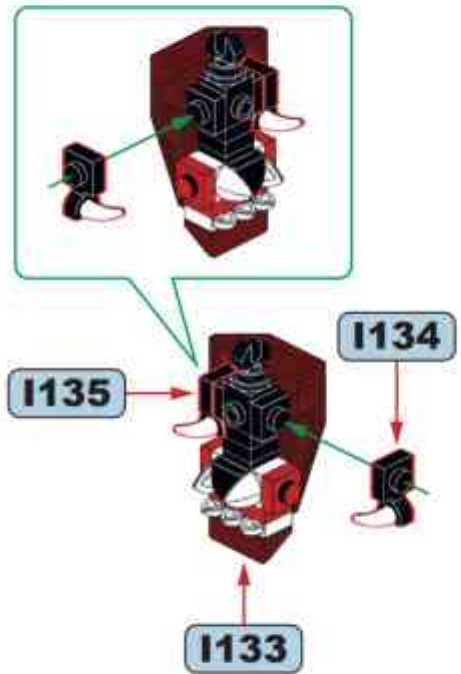

**I137**

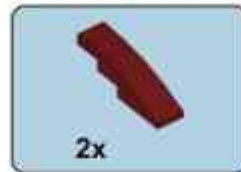
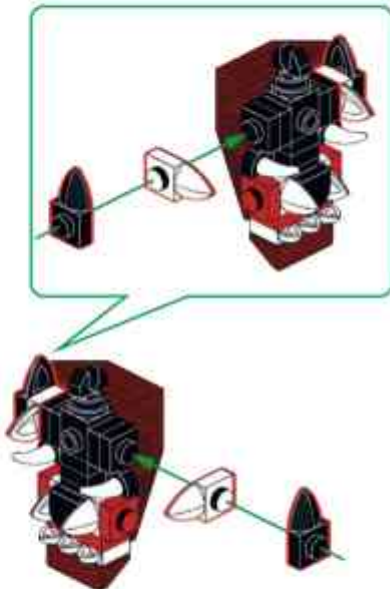

**I138**

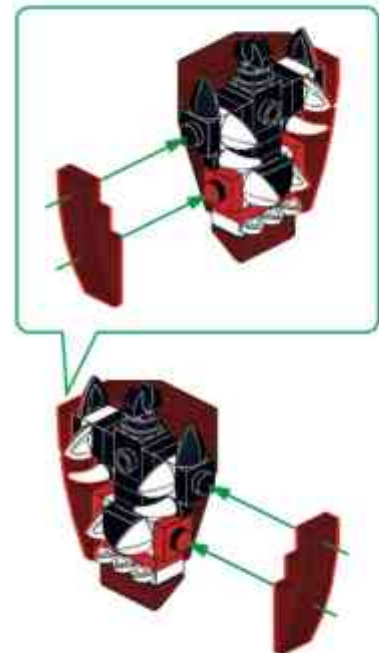



**I139**

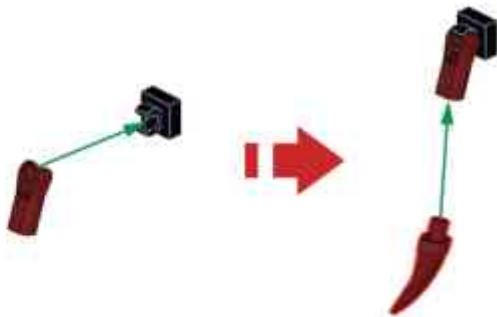

**I140**

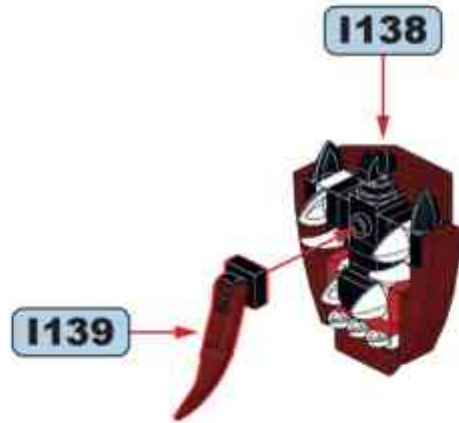

**I141**

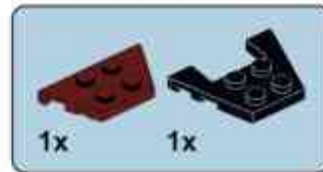
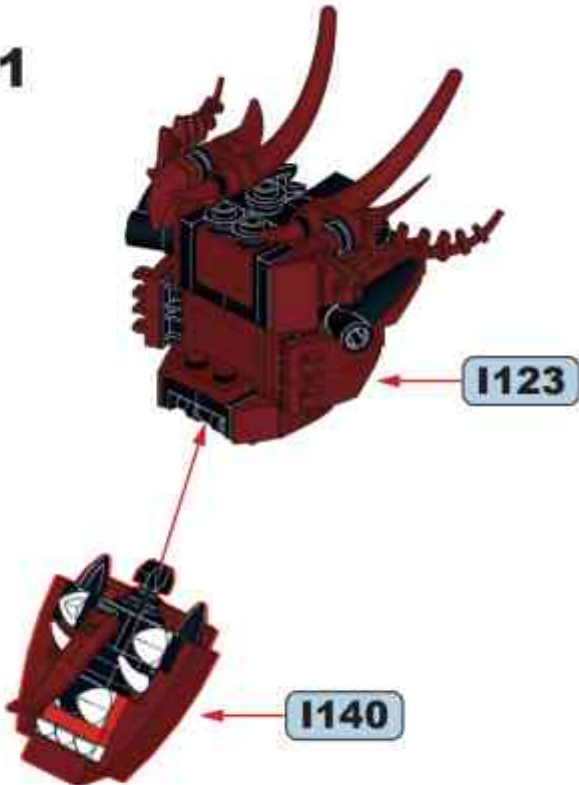

**I142**





**I143**



**I144**



**I145**

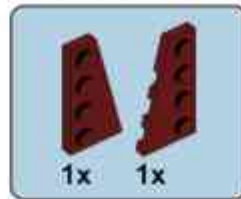

**I146**





**I147**



**I148**



**I149**

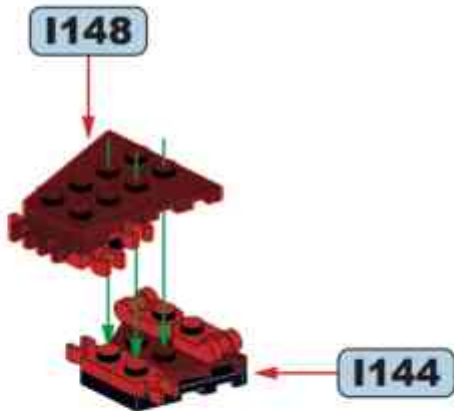

**I150**

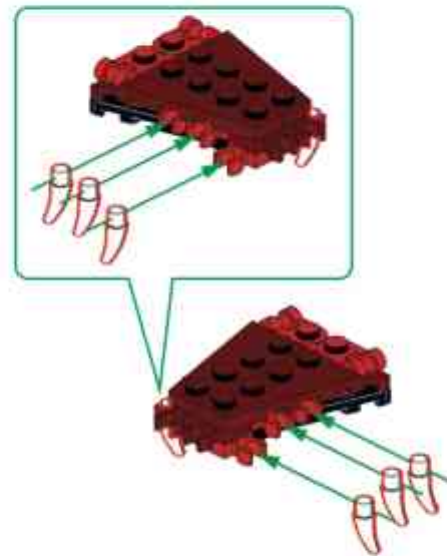



**I151**

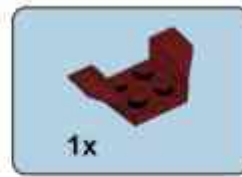
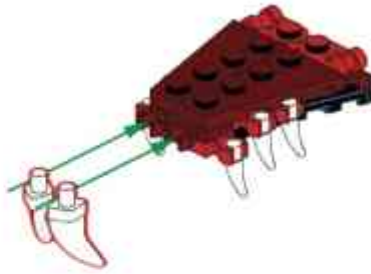

**I152**

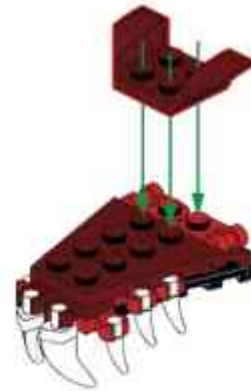

**I153**

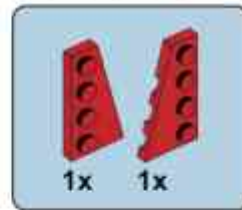
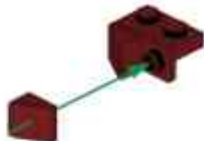

**I154**



# I155

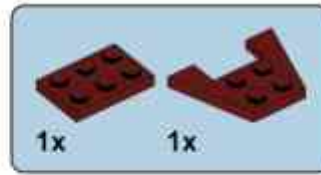

# I156



# I157

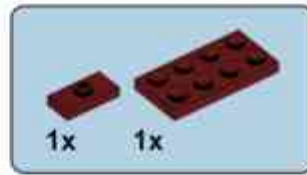
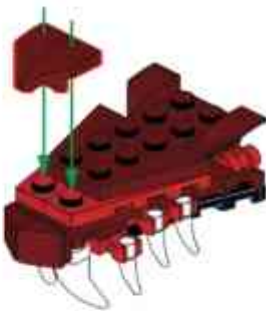

# I158





**I159**



**I160**



**I161**



**I162**



**I163**



**I164**





**I165**

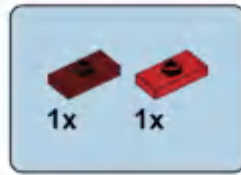

**I166**



**I167**



**I168**



**I167**

**I141**

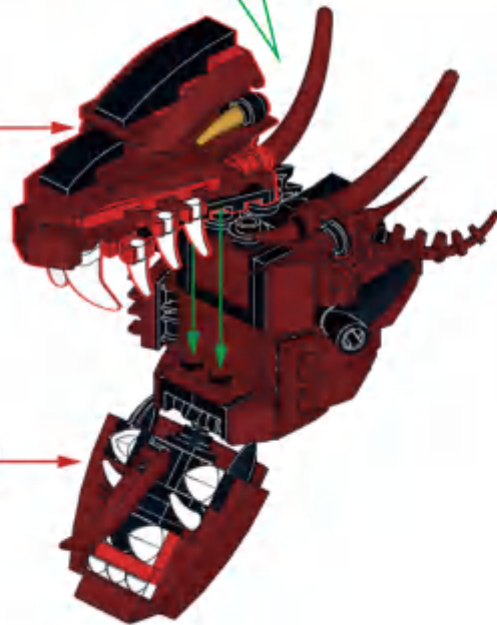

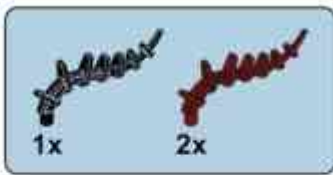

**I169**



**I170**



**x2**



**I171**



**x2**

# I172

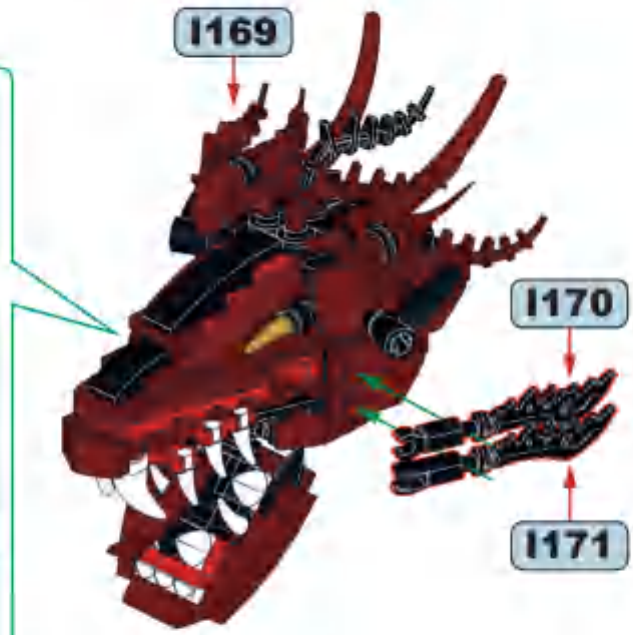

# I173



I181

I172



10



1x 1x

**J1**



1x

**J2**



1x 1x

**J3**



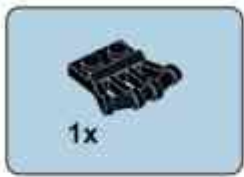

**J4**

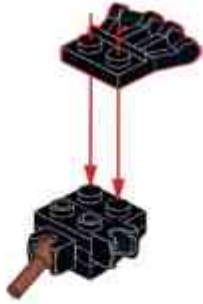

**J5**



**J6**



**J7**

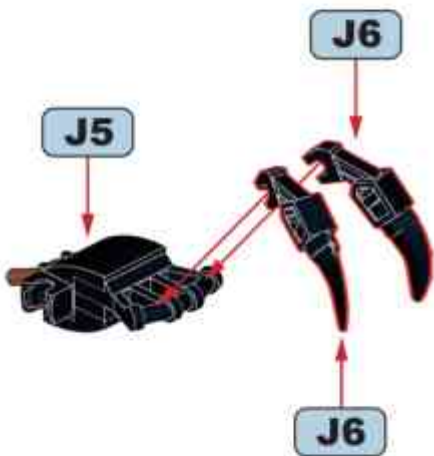

**J8**

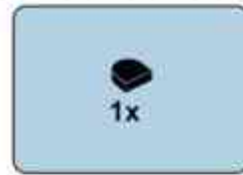

**J9**





**J10**



**J11**

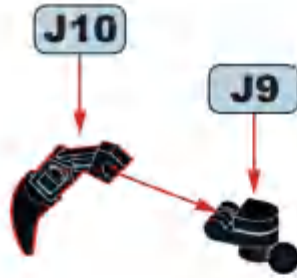

**J12**

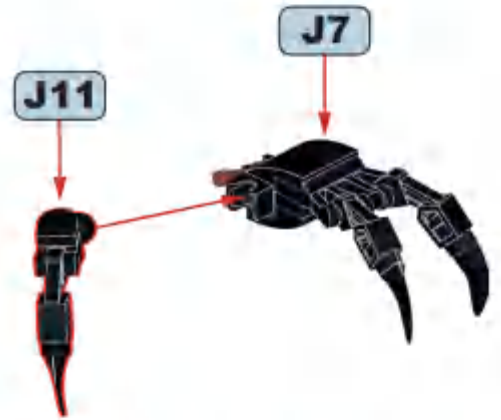

**J13**

**I173**

**J12**





**J14**

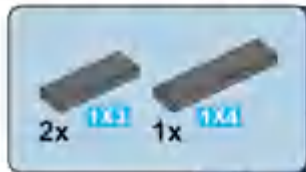

**J15**

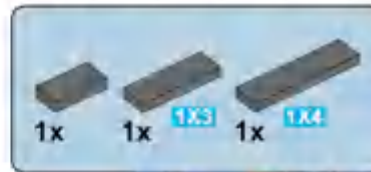

**J16**





**J17**



**J18**



**J19**



**J20**





**J21**

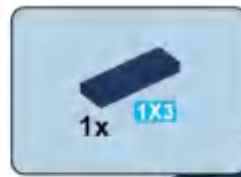

**J22**



**J23**



**J24**



**J25**



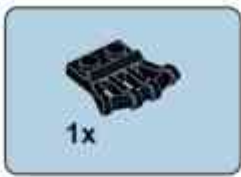

**J26**



**J27**



**J28**



**J29**



**J30**

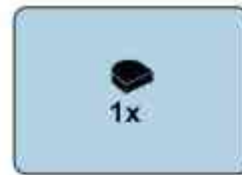

**J31**





**J32**



**J33**



**J34**

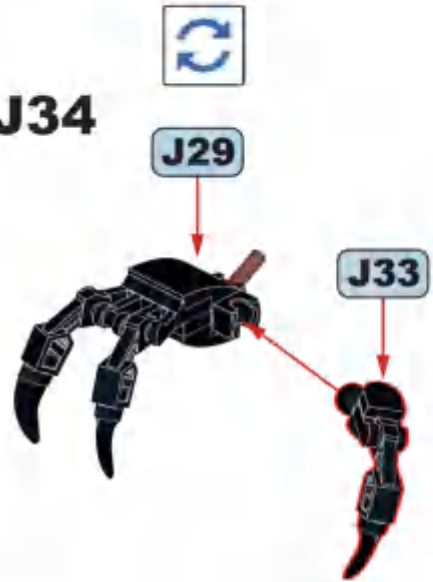

**J35**



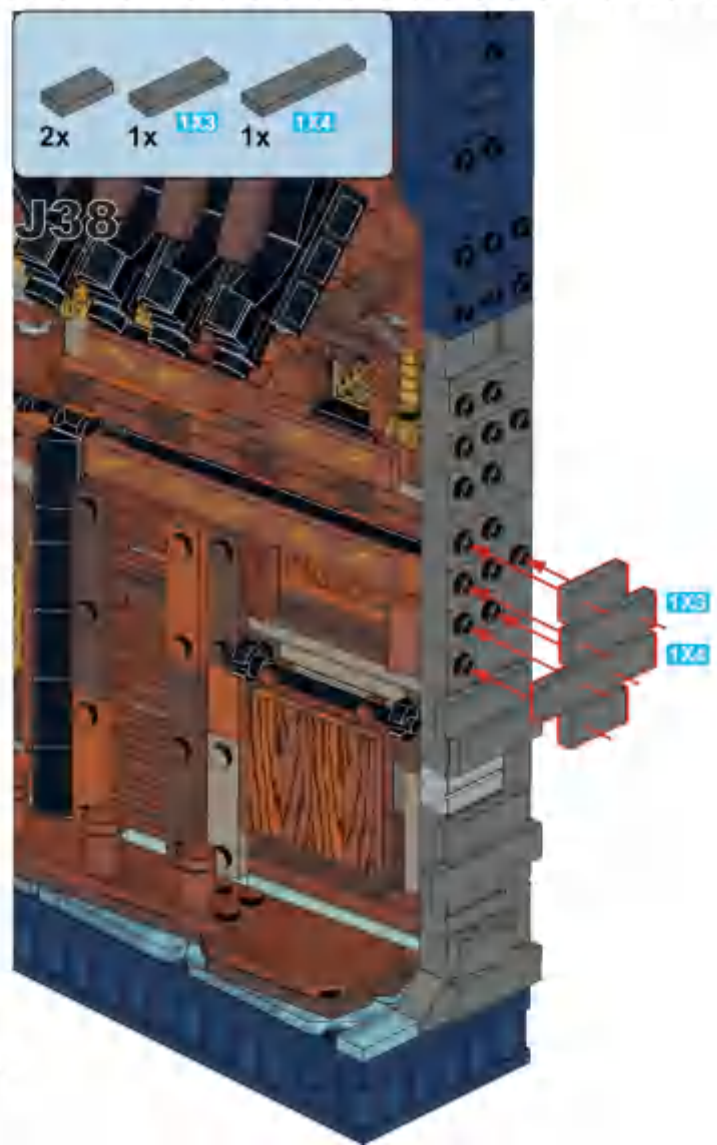
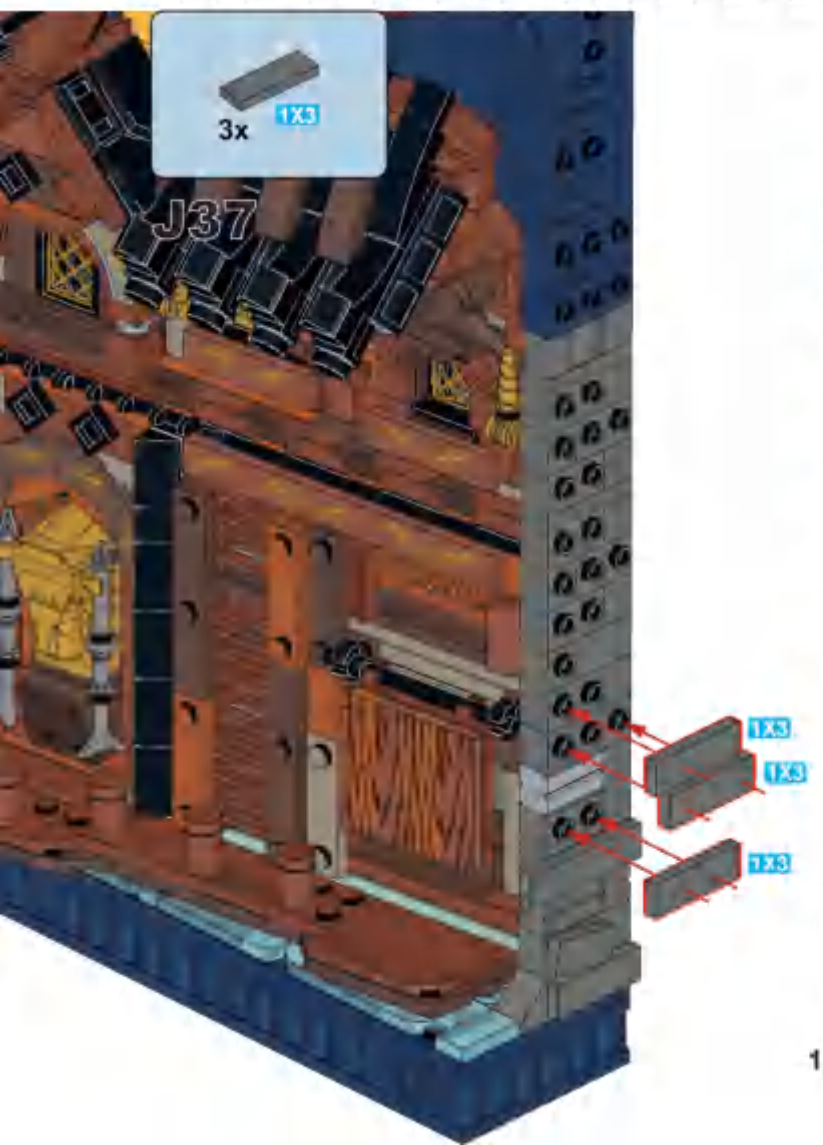

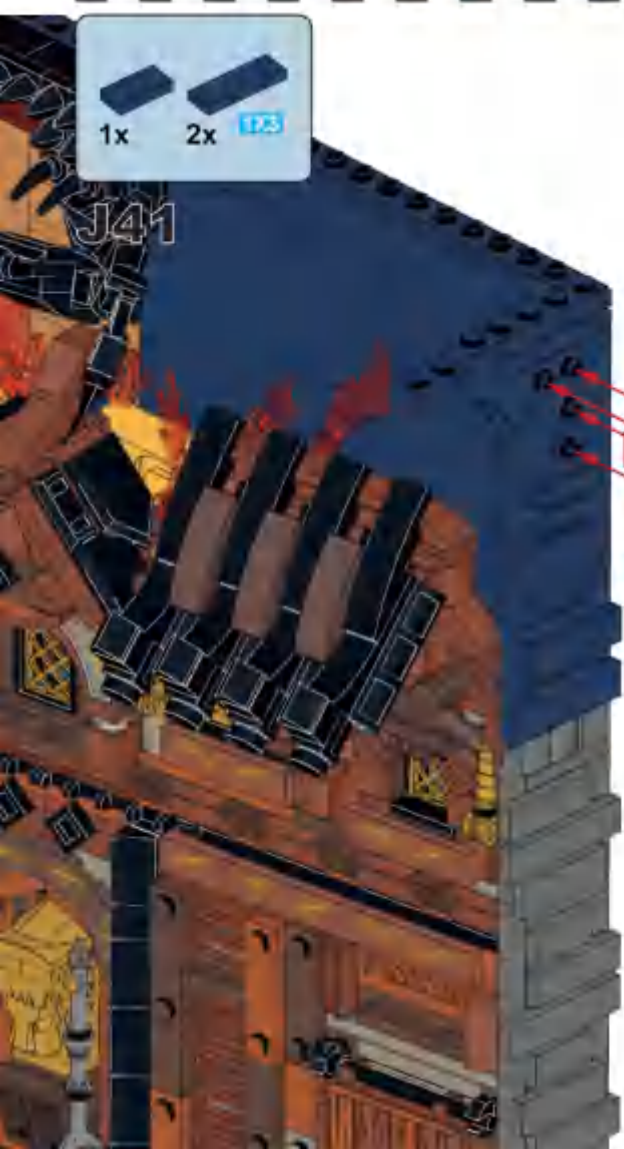
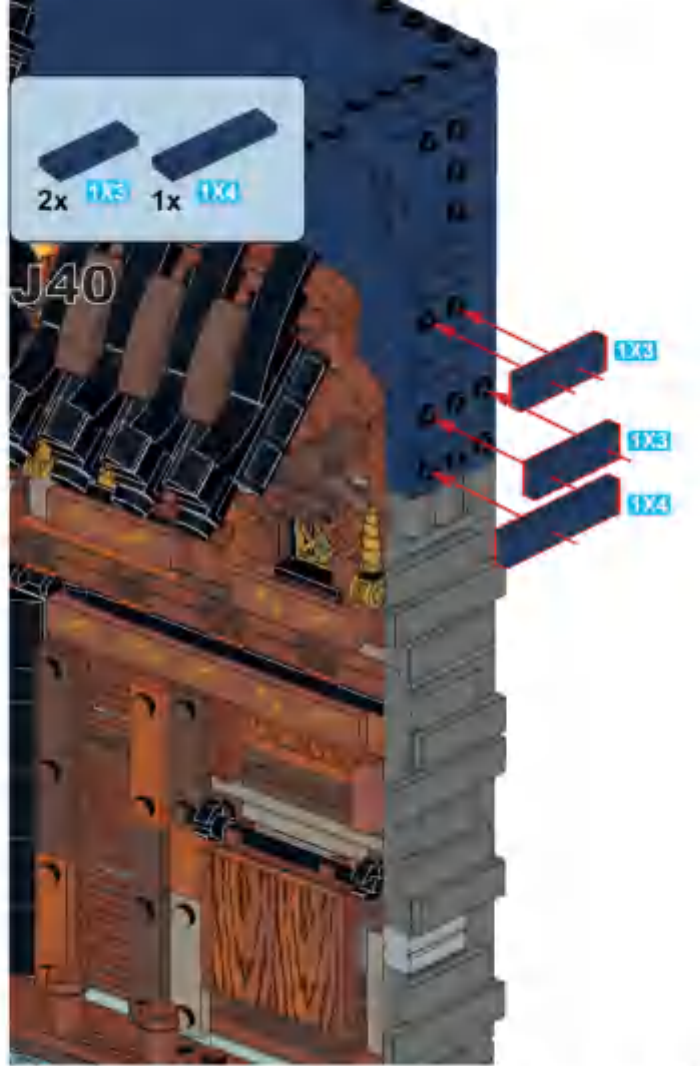

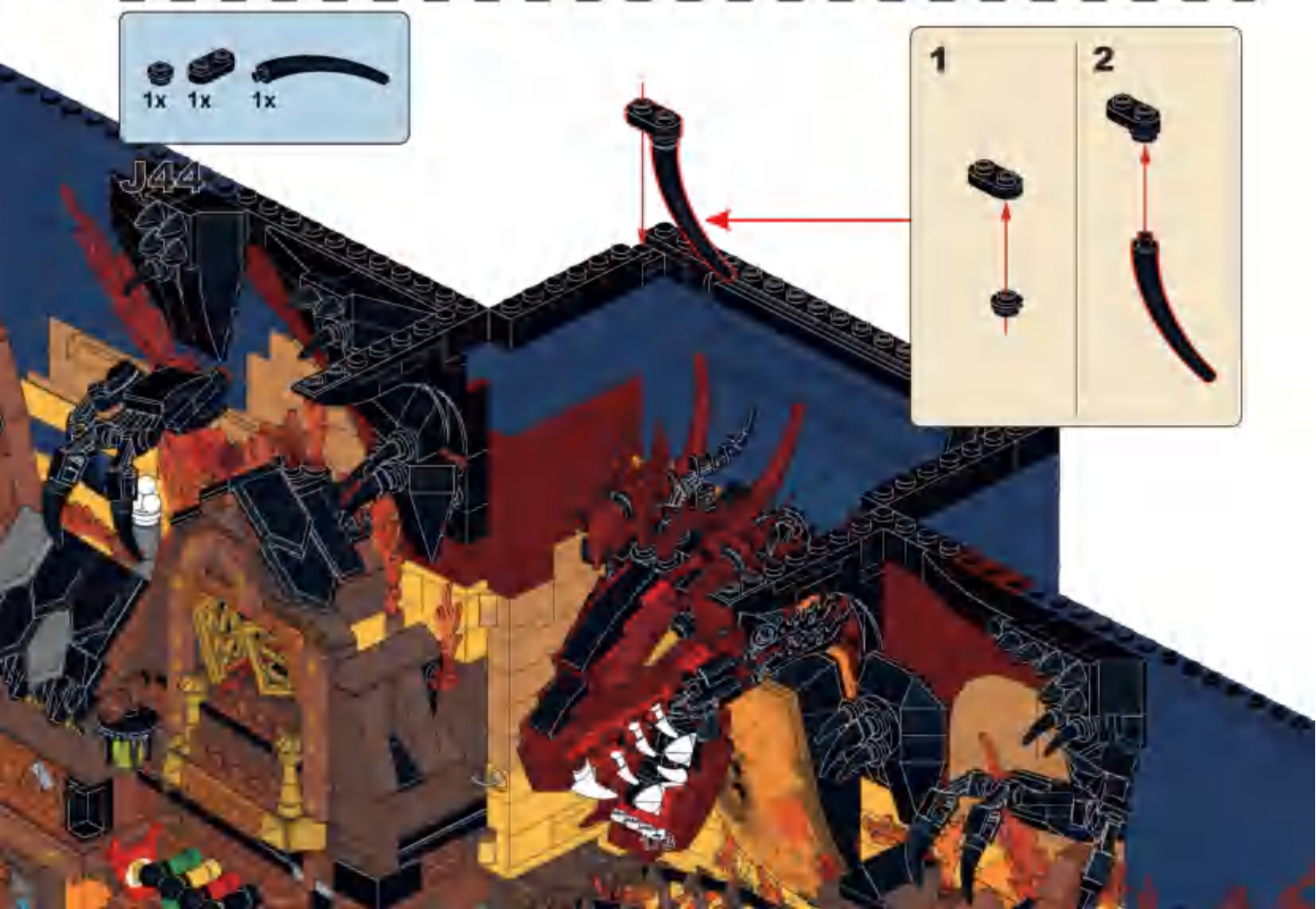

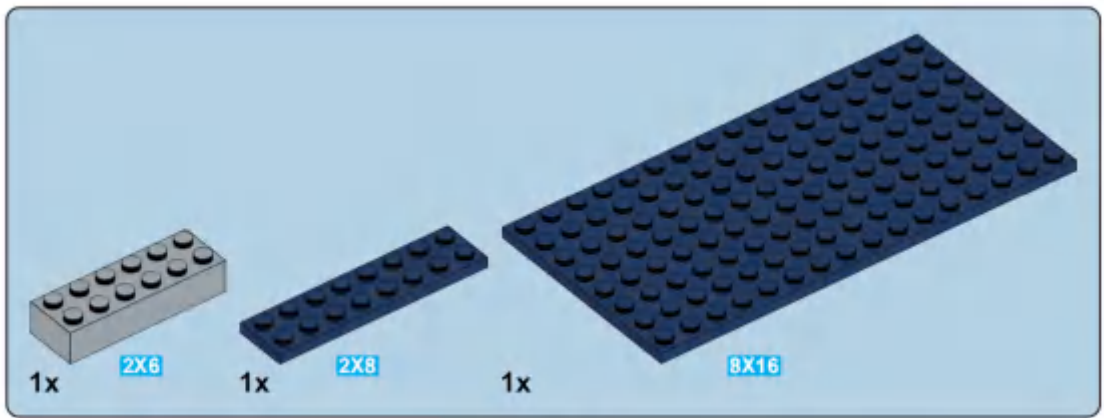

### J45

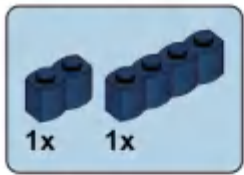
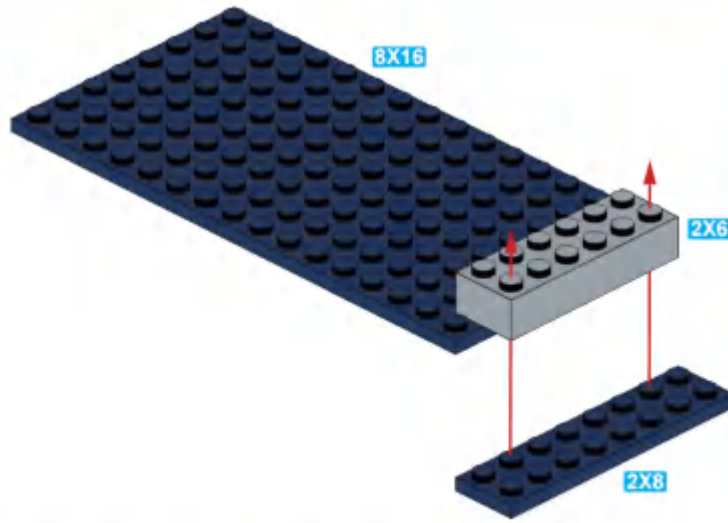

### J46

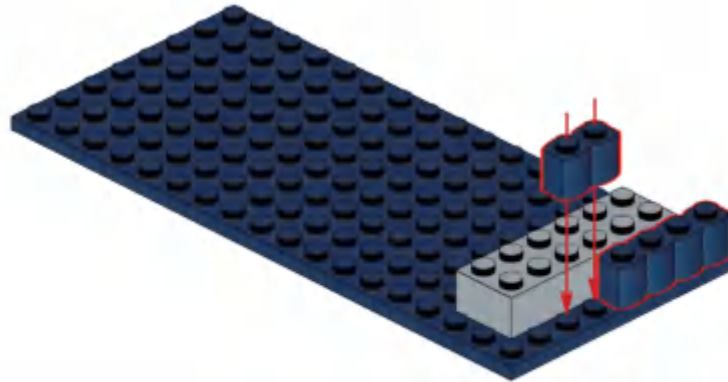

### J47

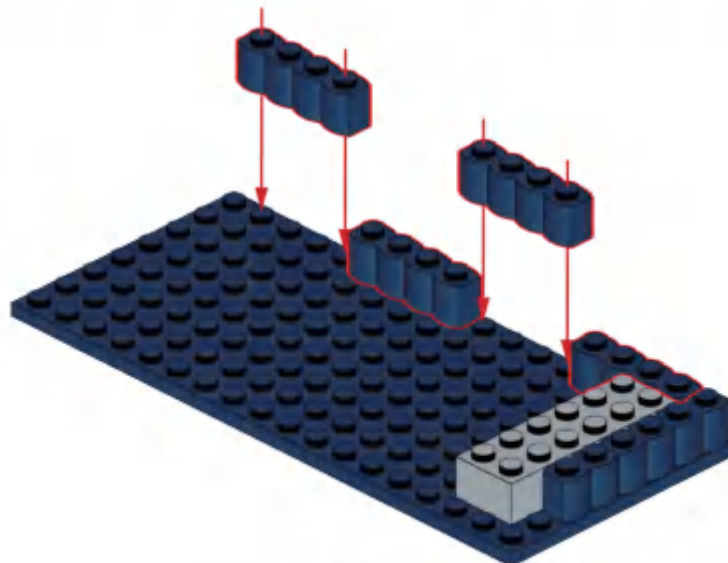



**J51**

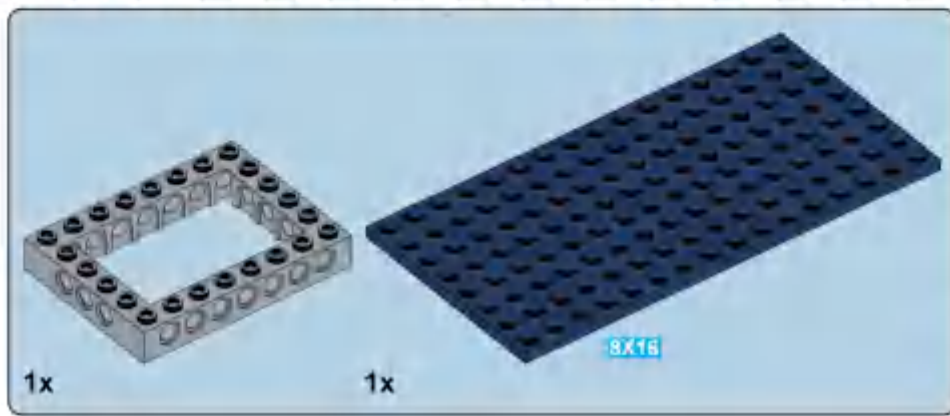
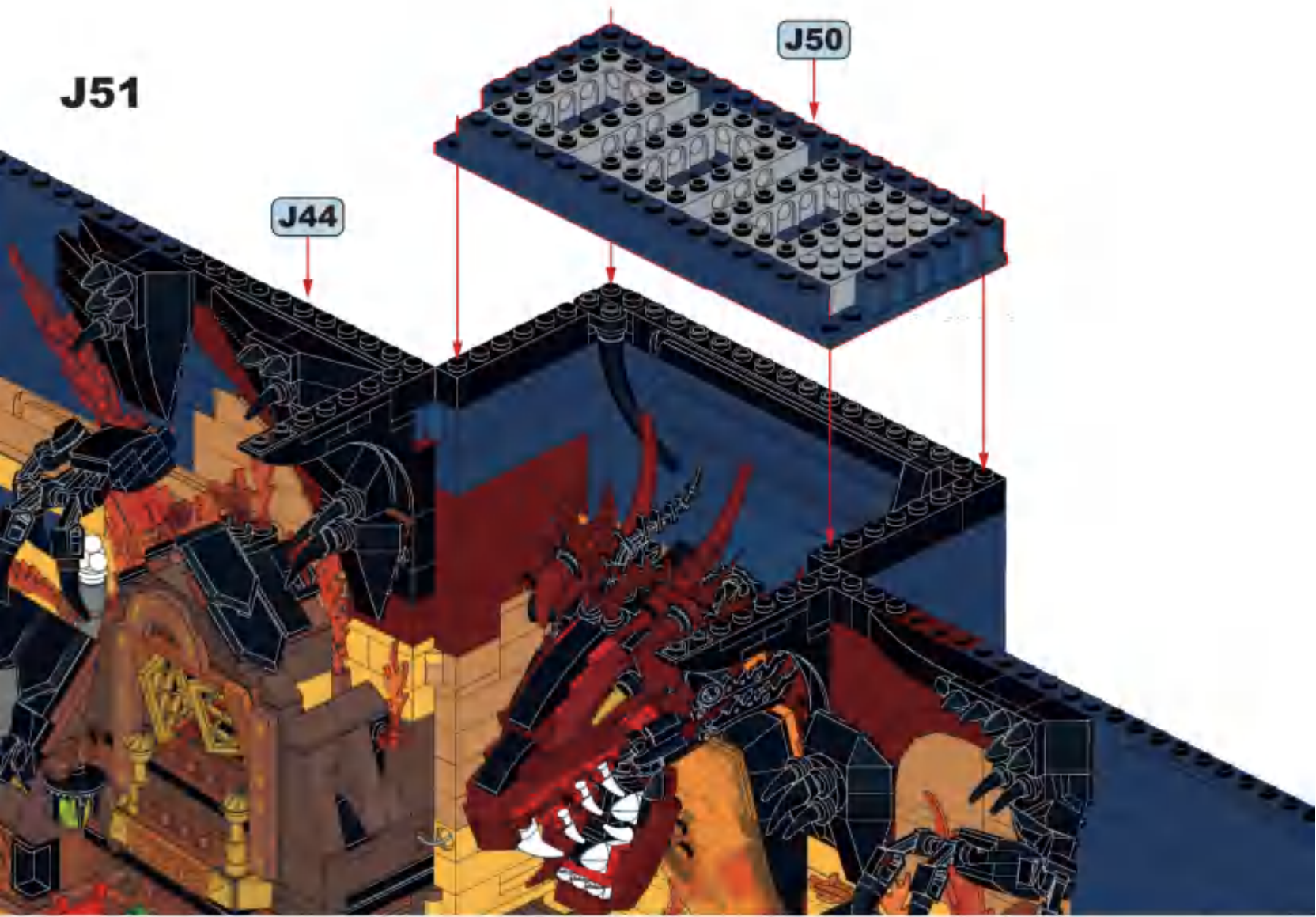

**J52**

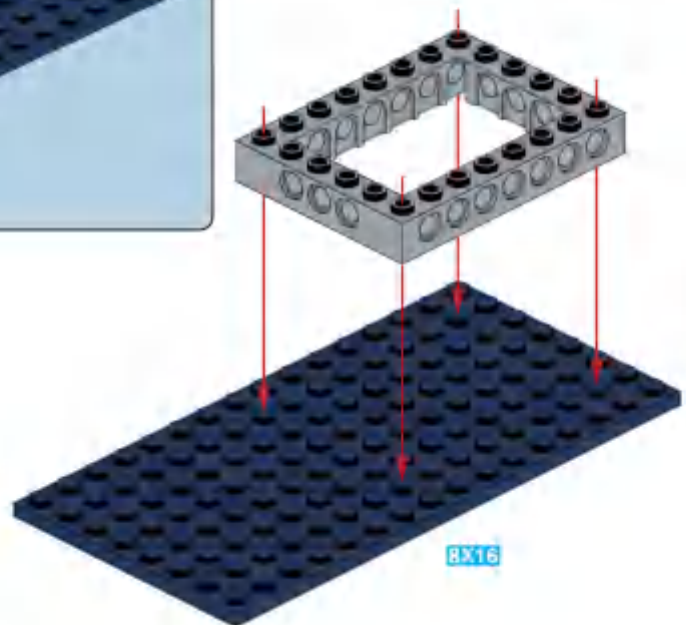

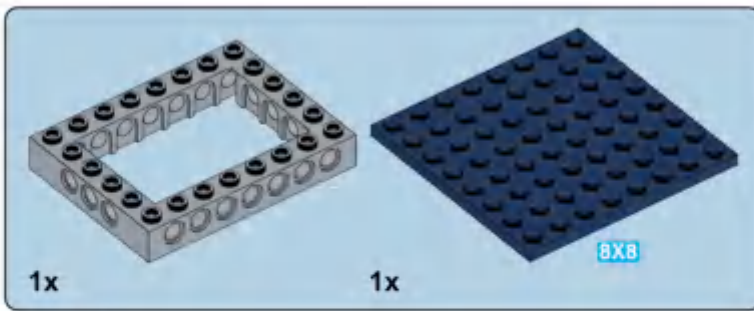

## J53

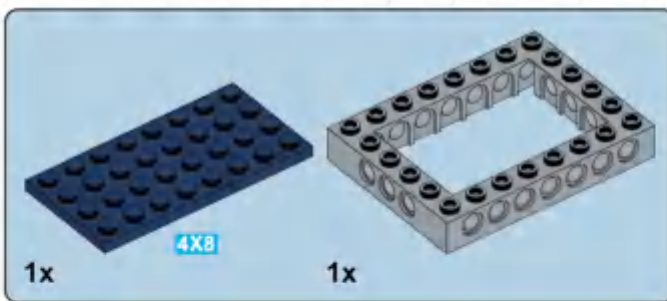
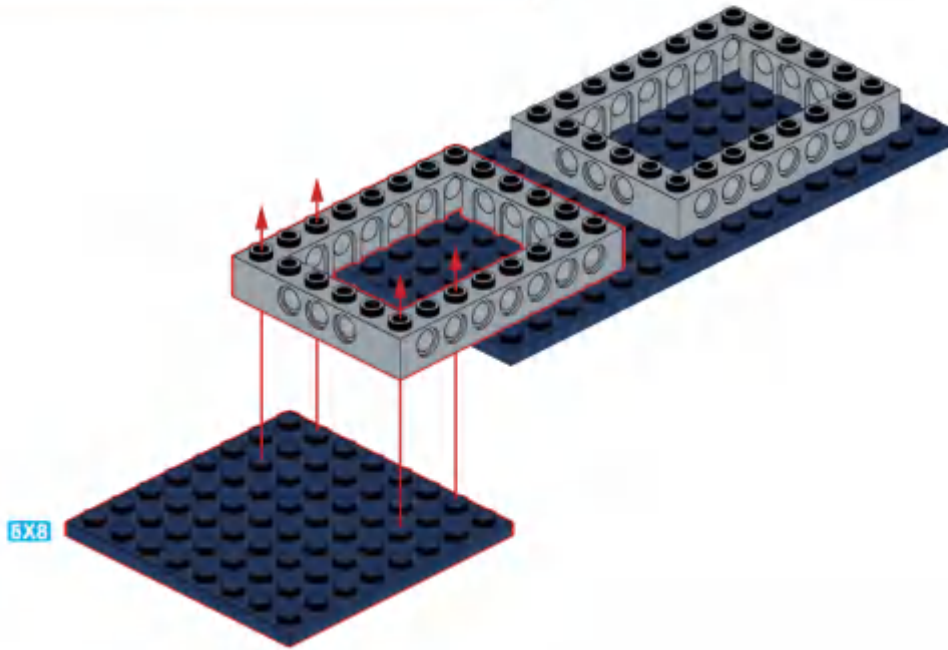

## J54

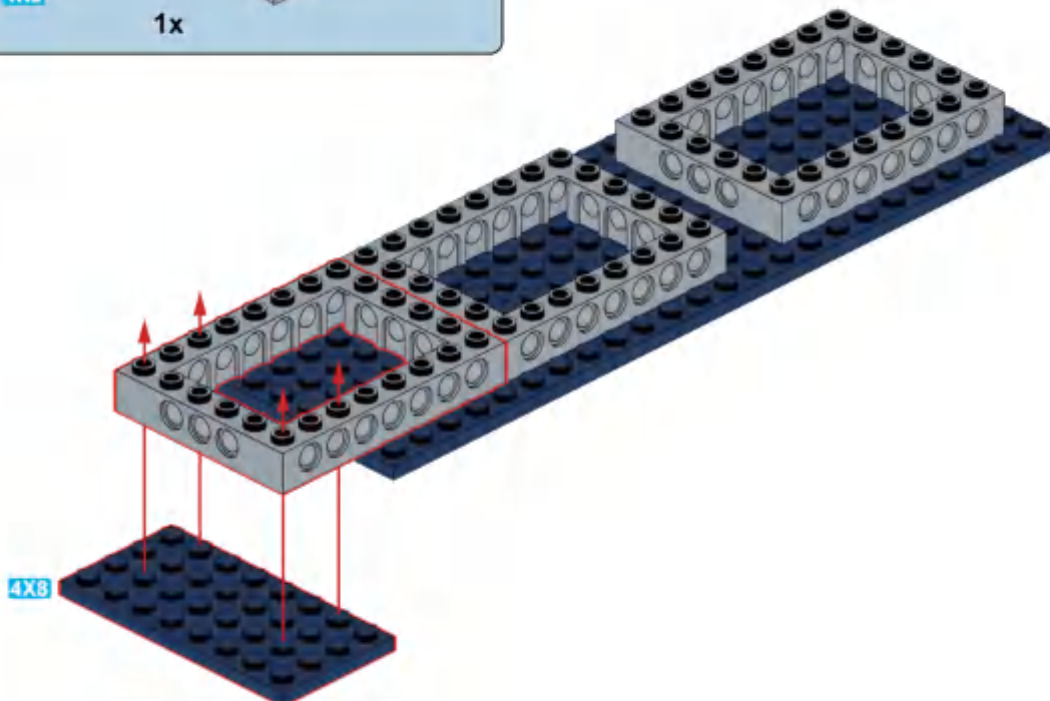

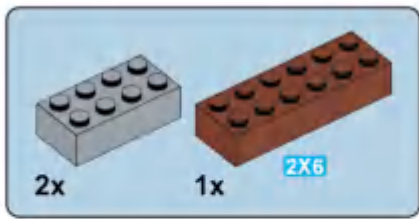

**J55**

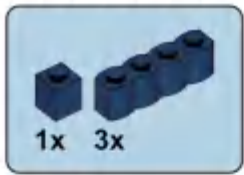
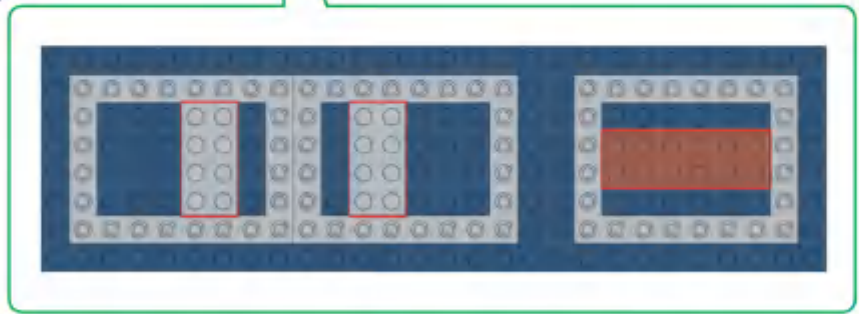
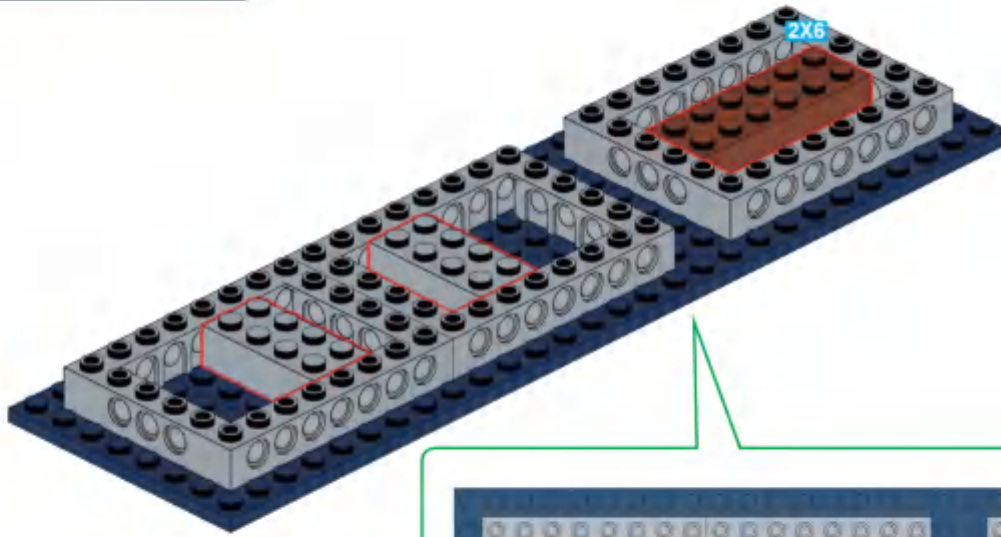

**J56**

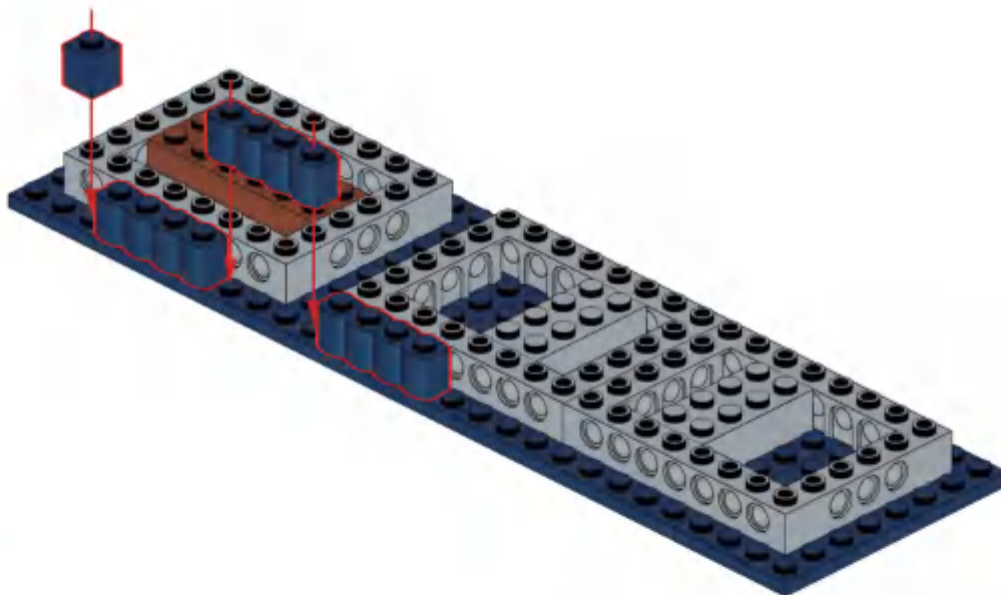



**J57**

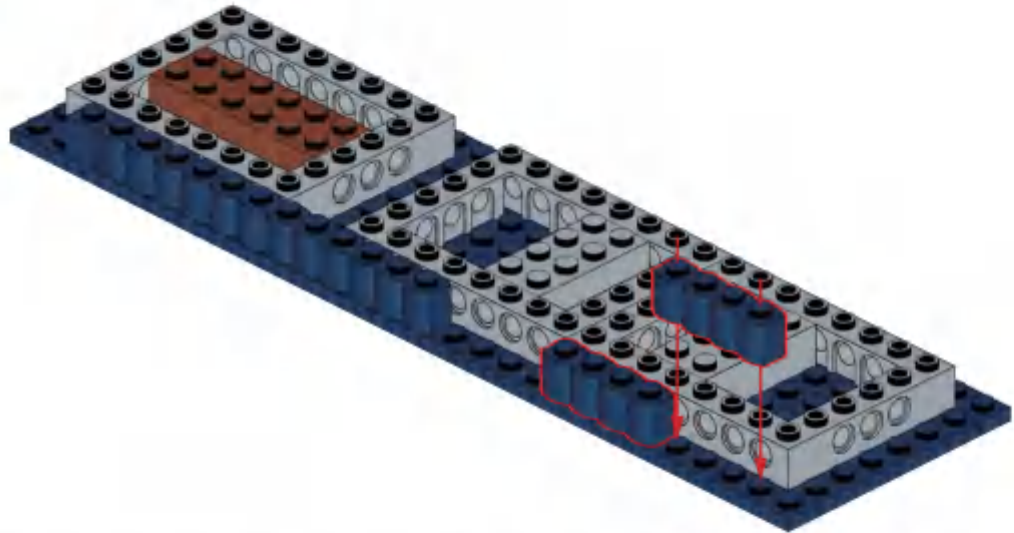

**J58**

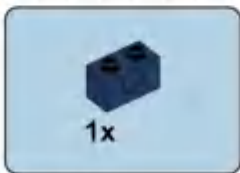
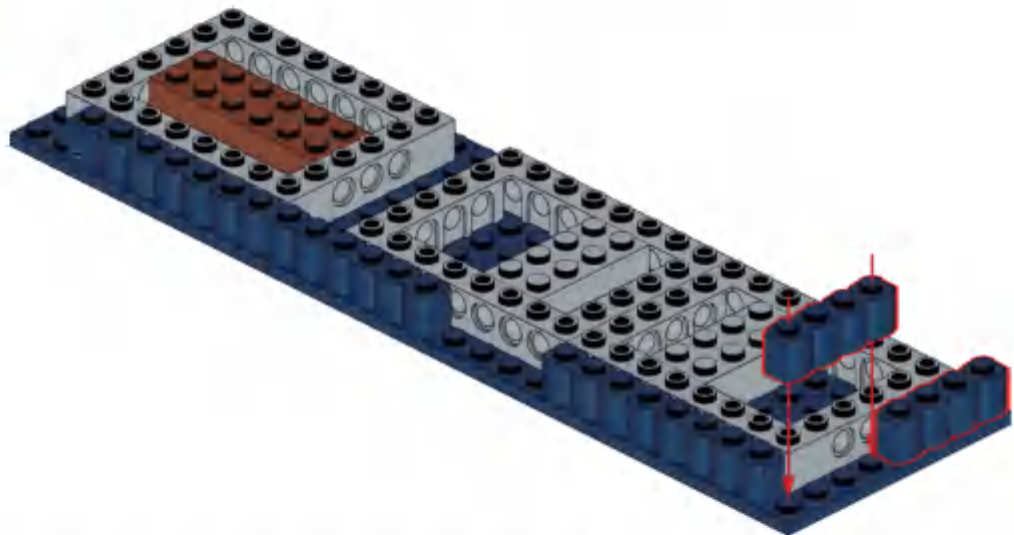

**J59**

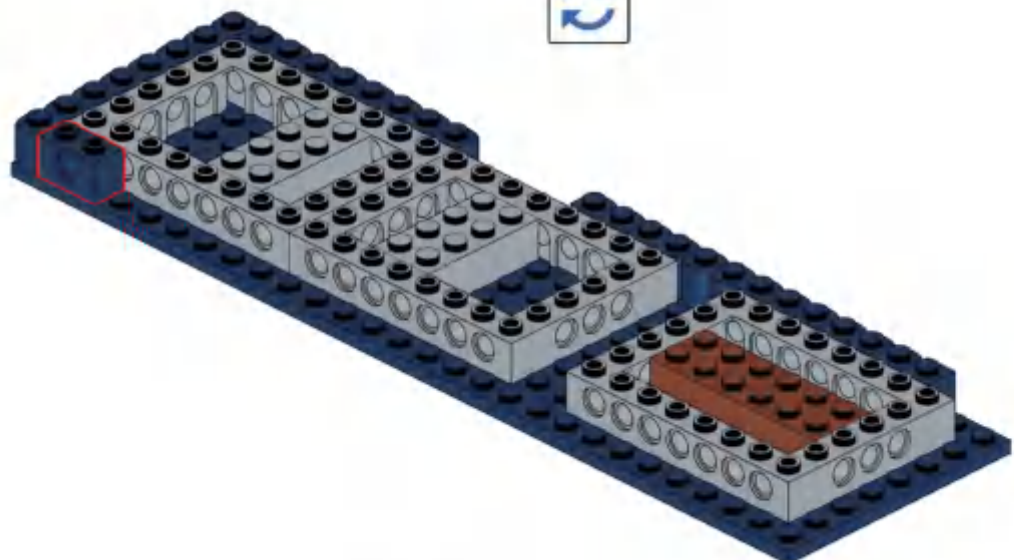



**J60**

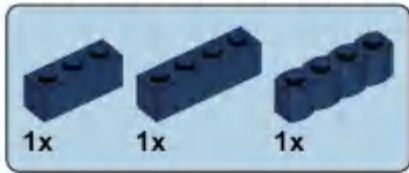
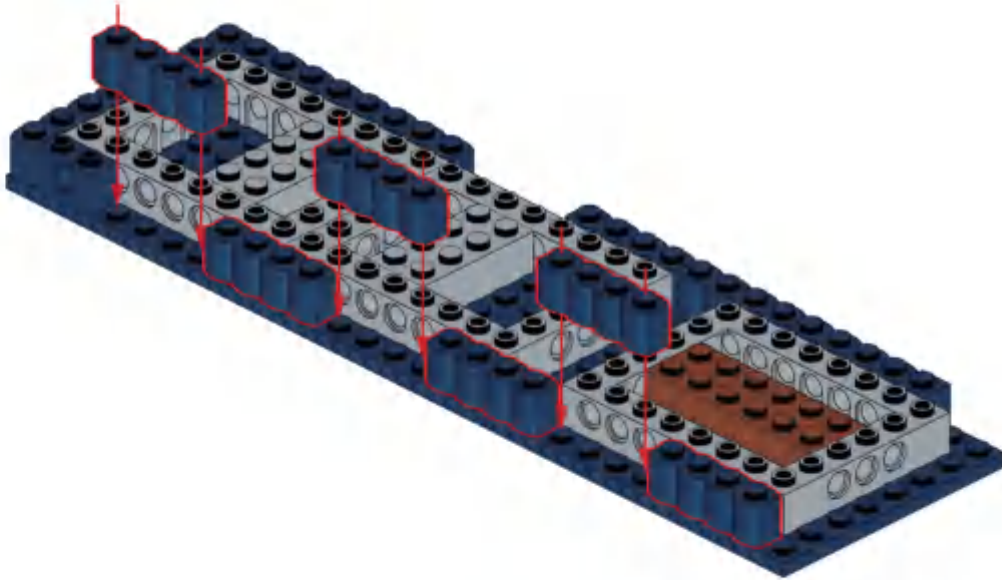

**J61**

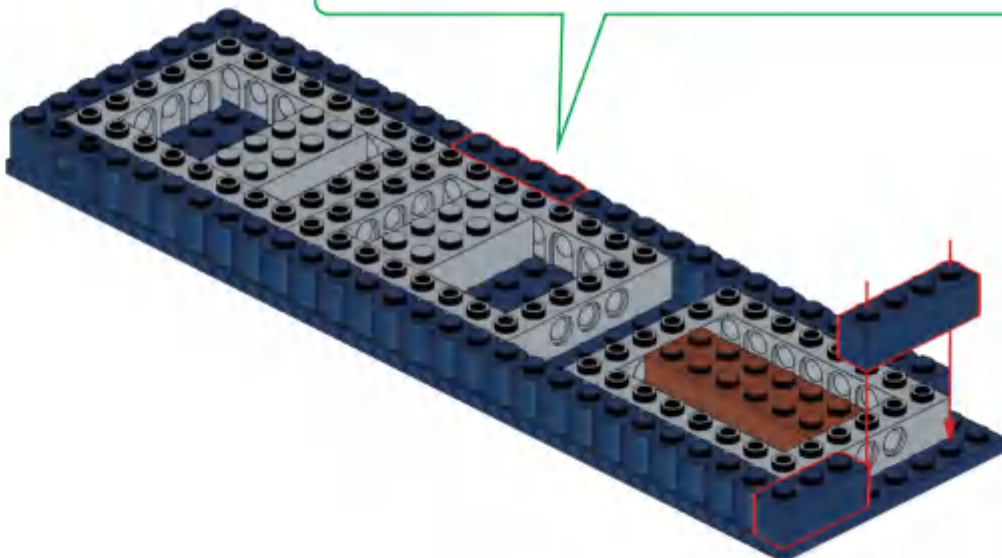
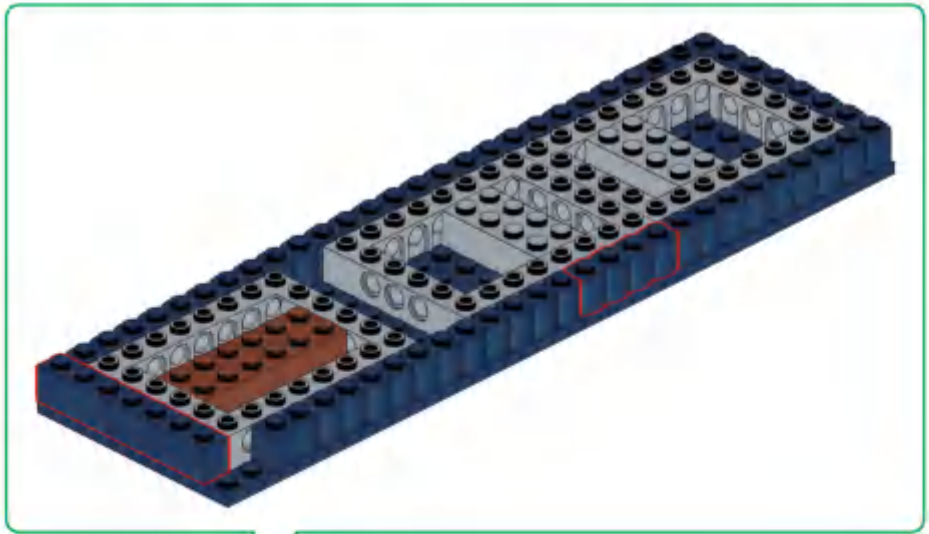

J62

J61

J51

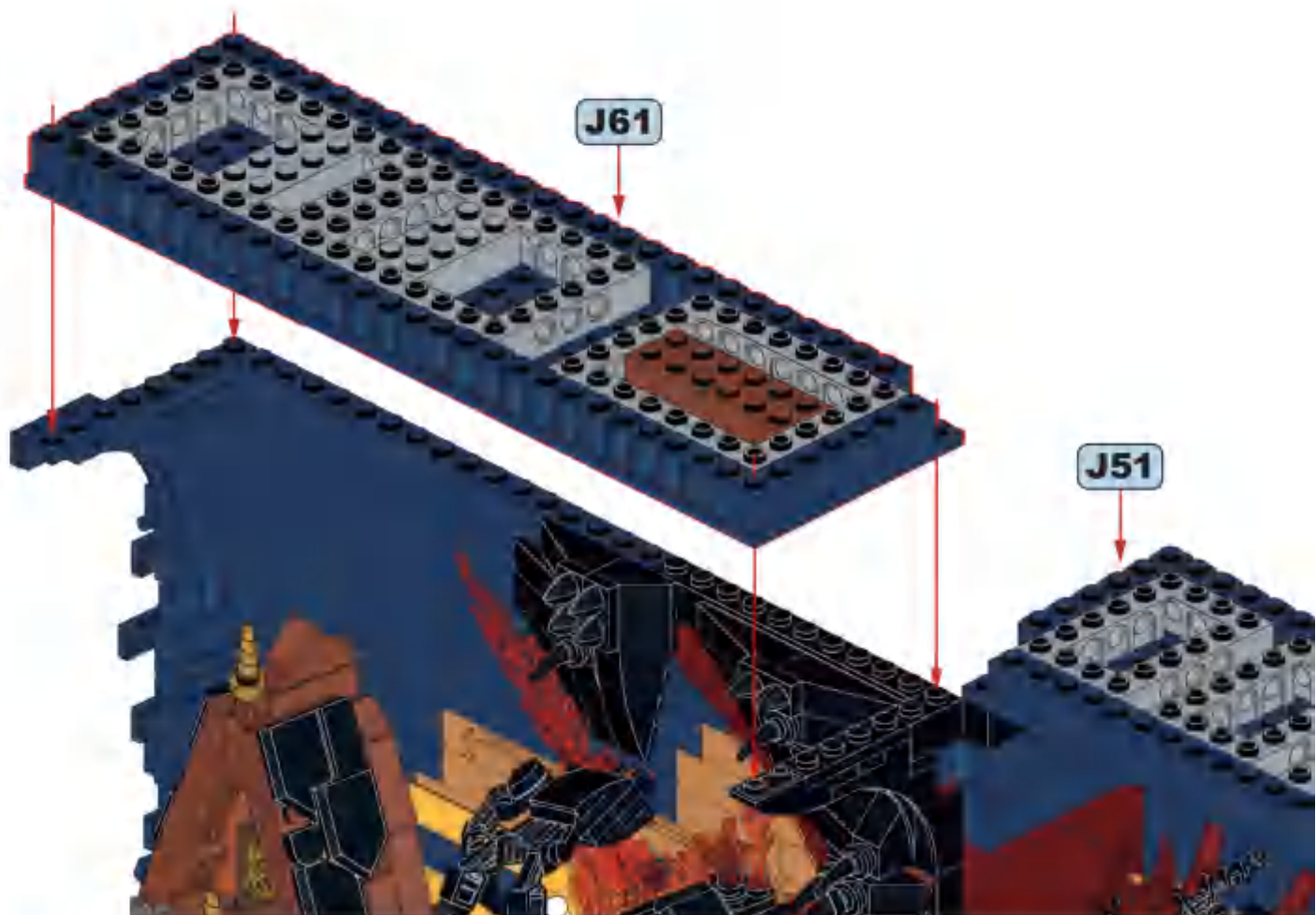

J63

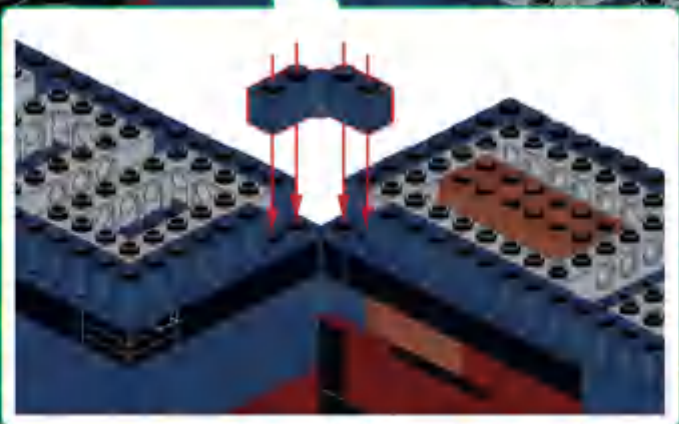
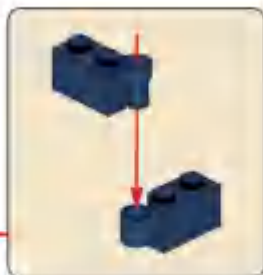

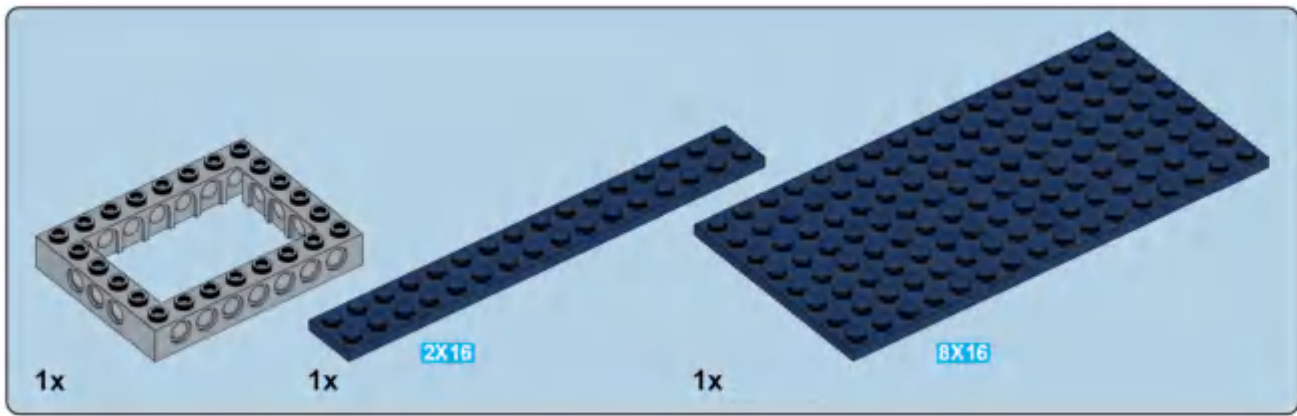

## J64

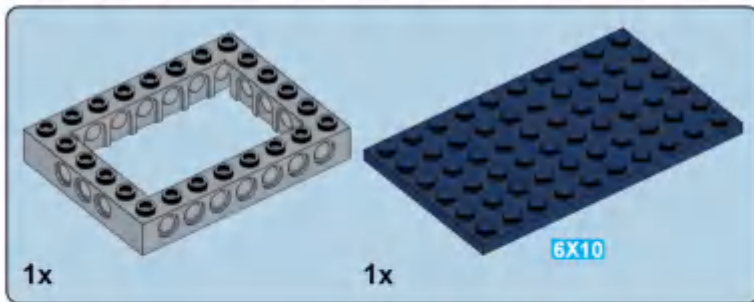
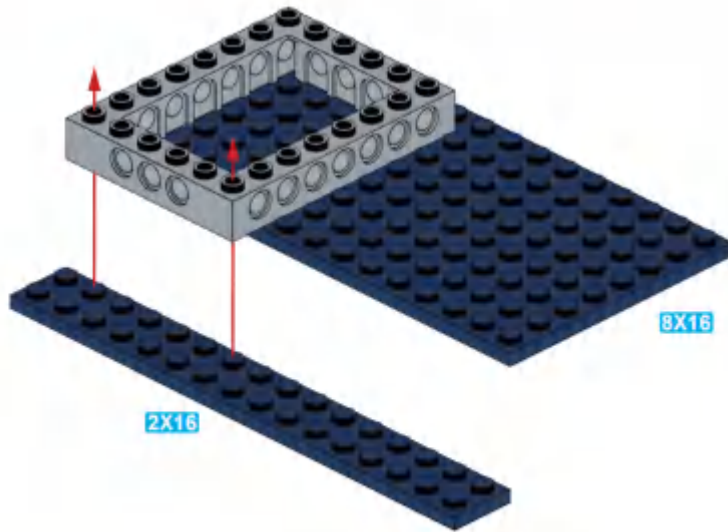

## J65

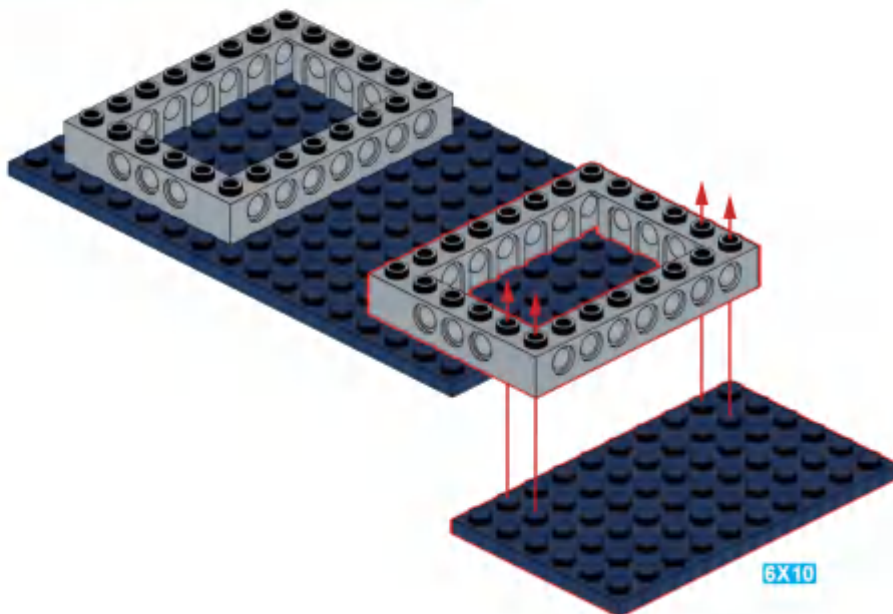

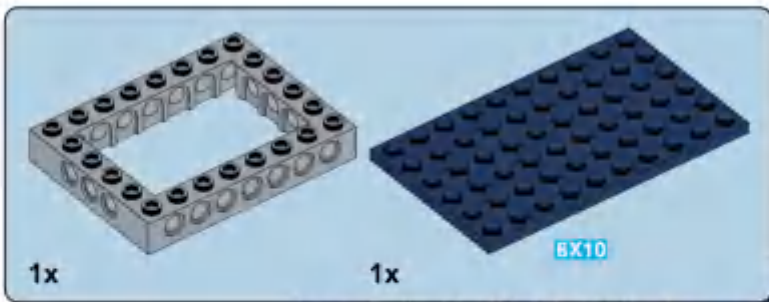

## J66

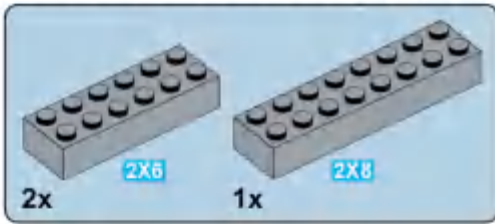
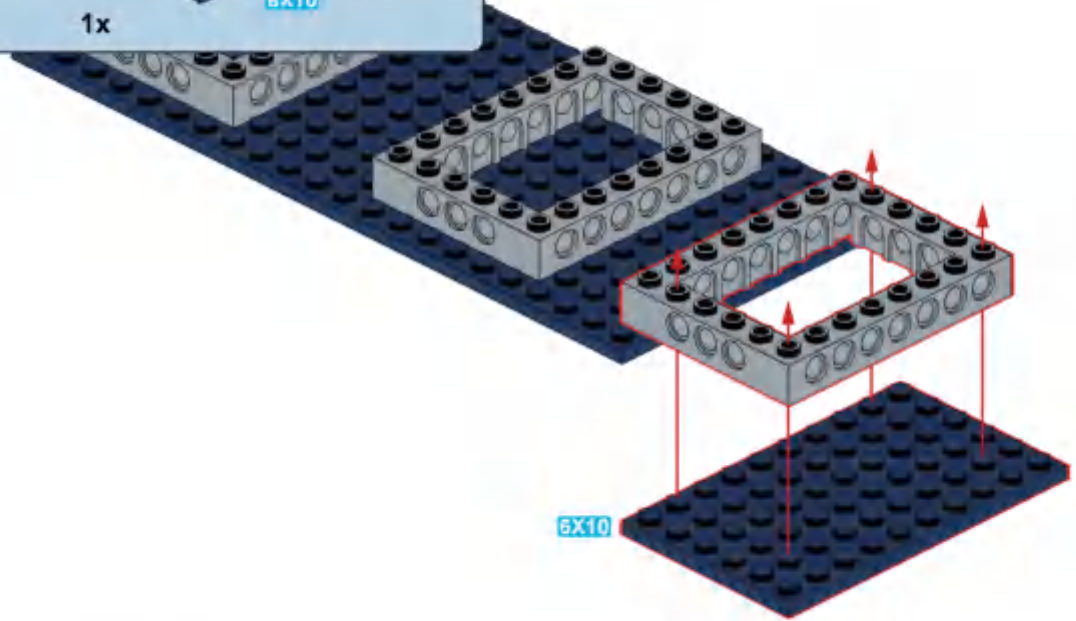

## J67

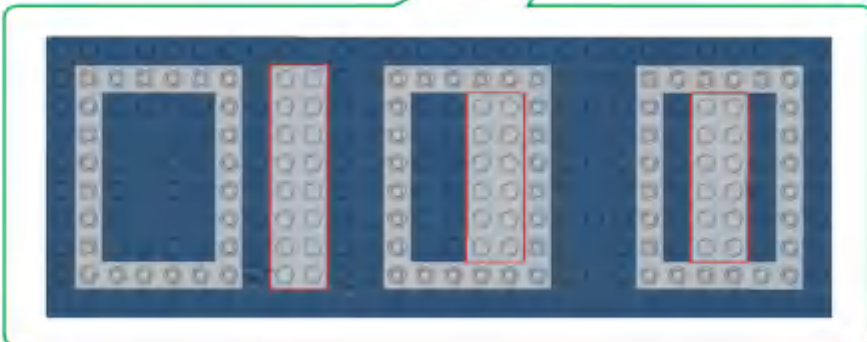
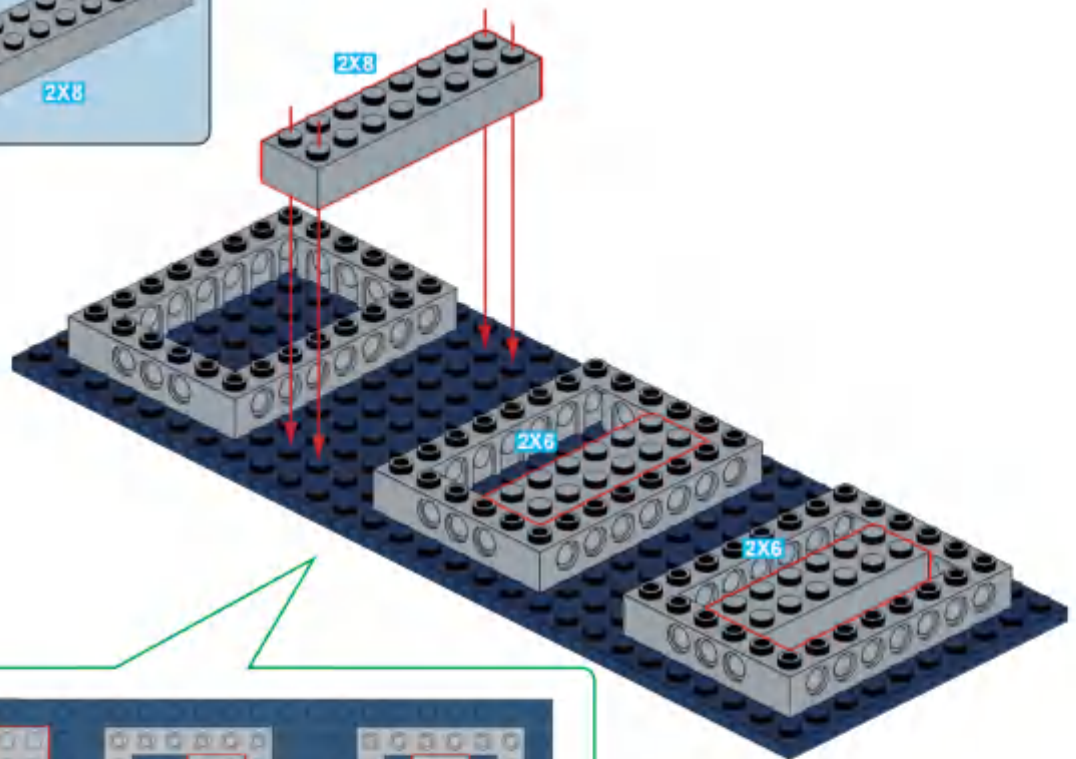



**J68**

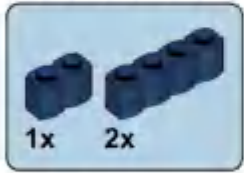
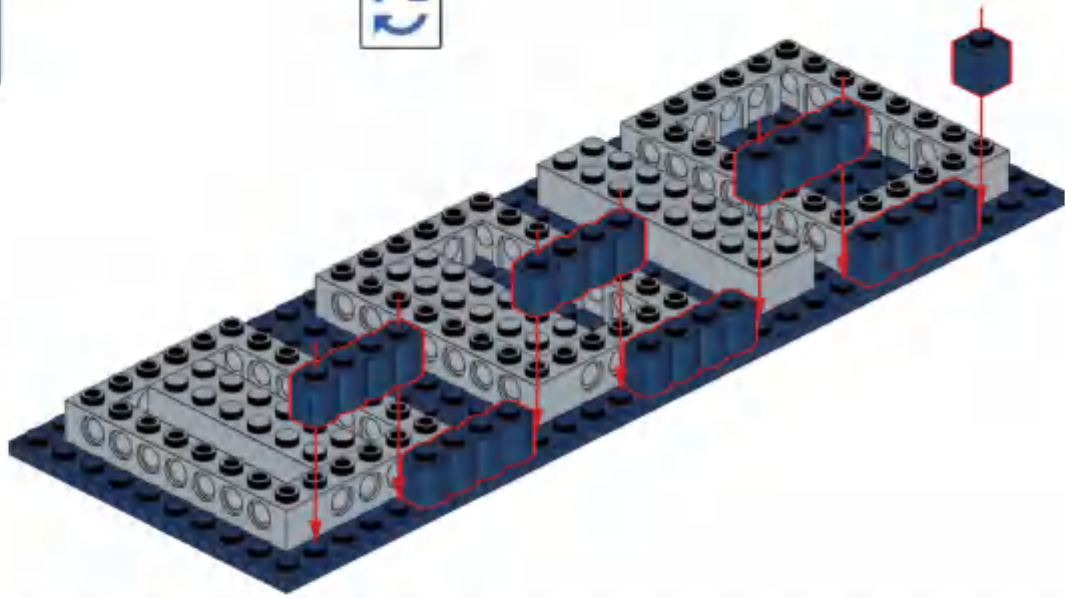

**J69**

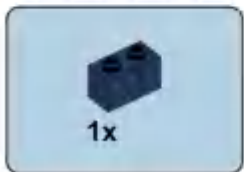
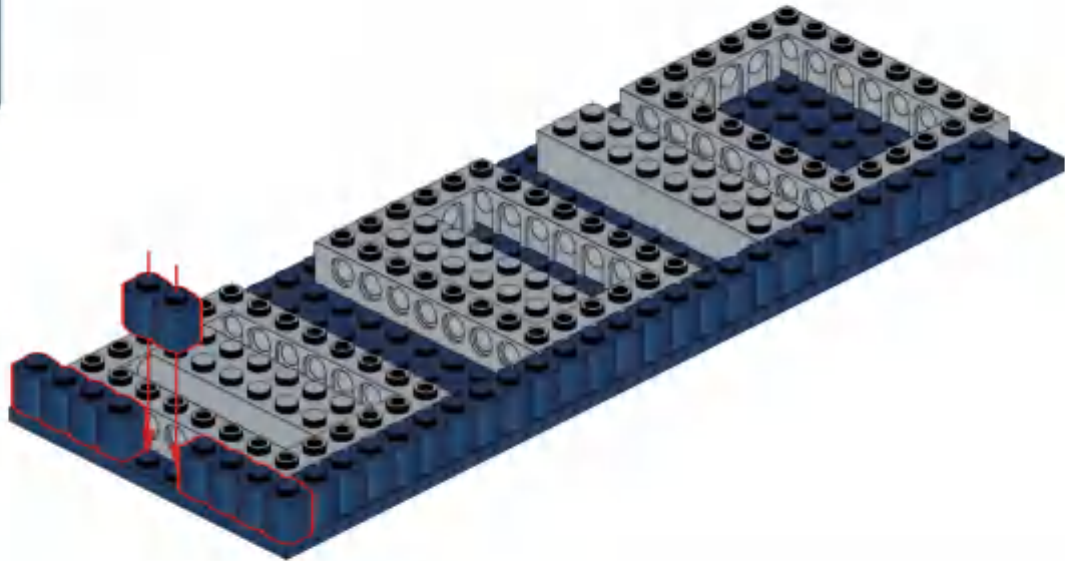

**J70**

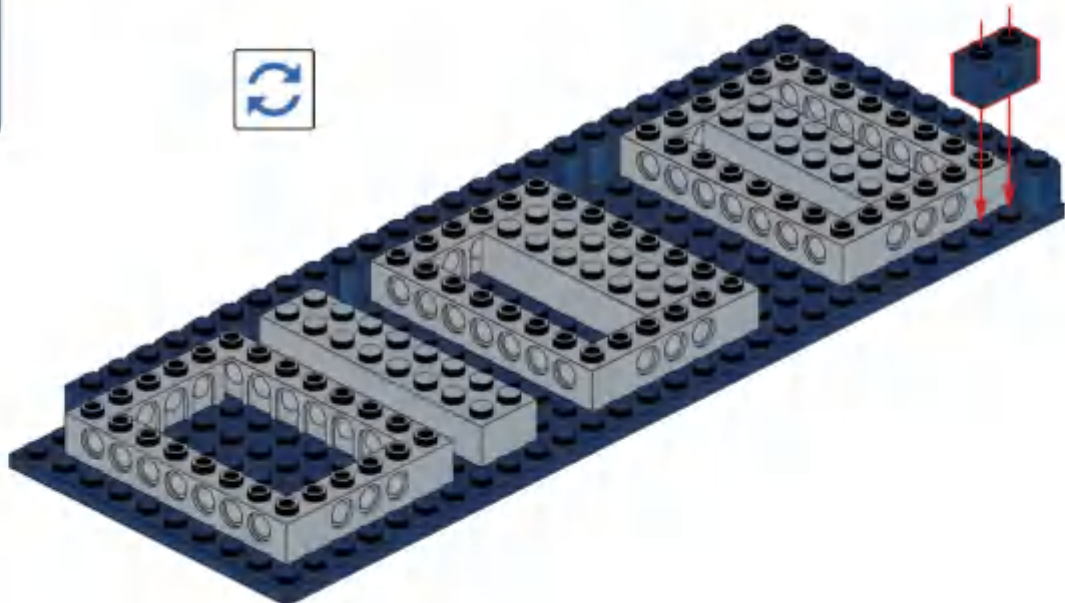





**J73**

**J72**

**J63**

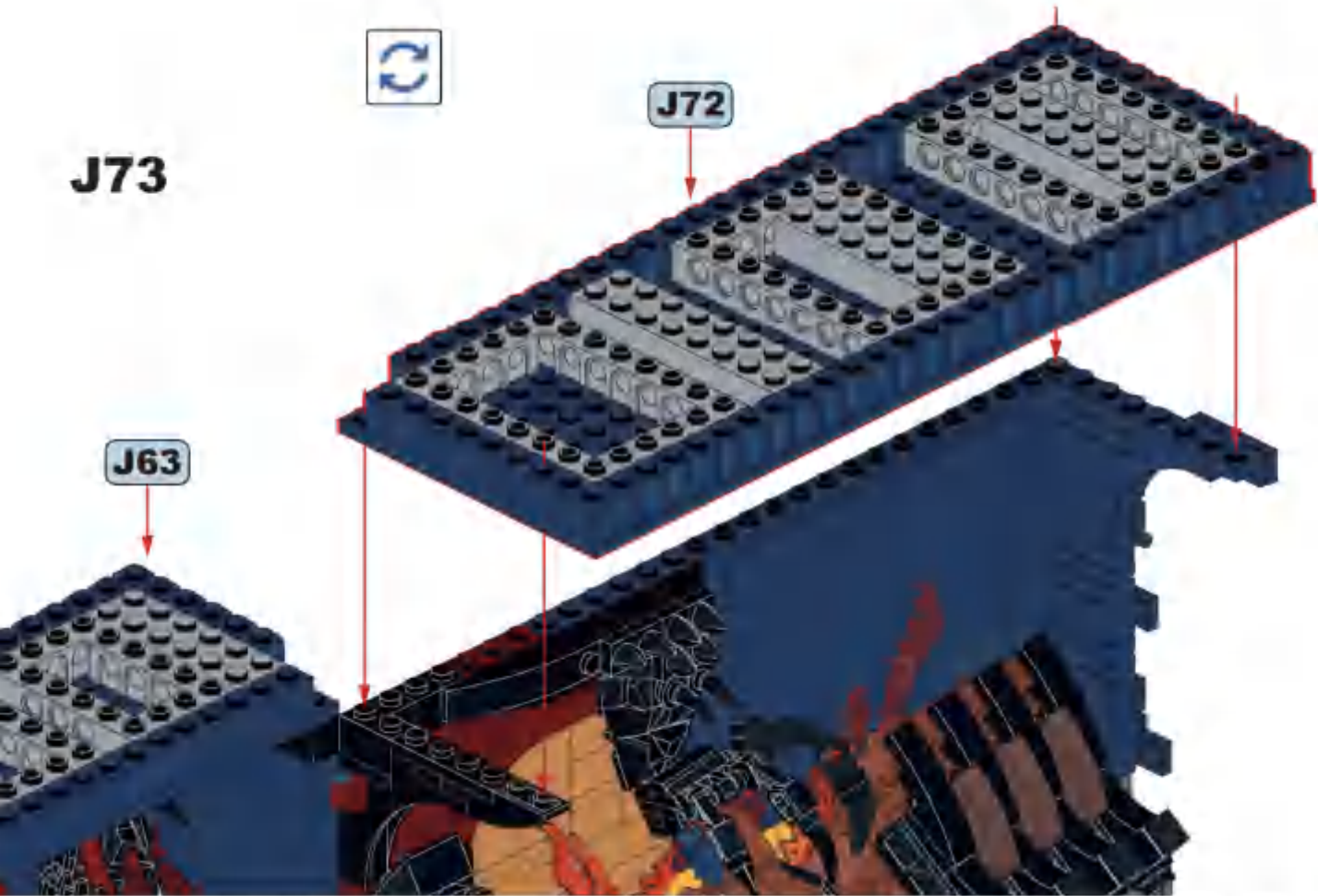

**J74**

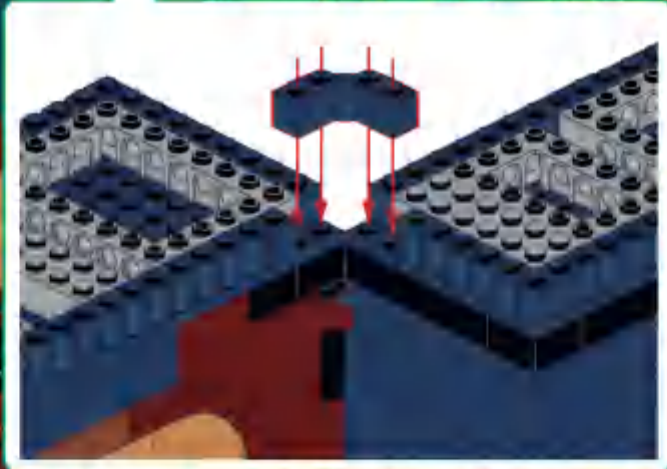
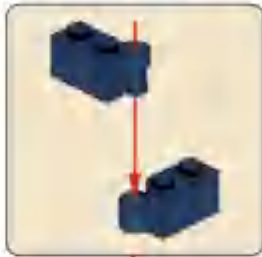

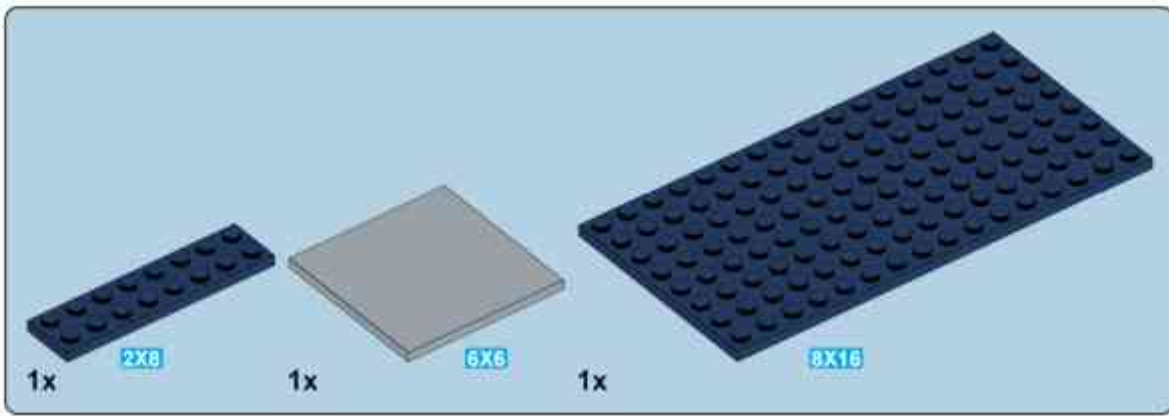

## J75

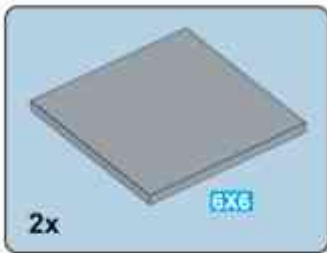
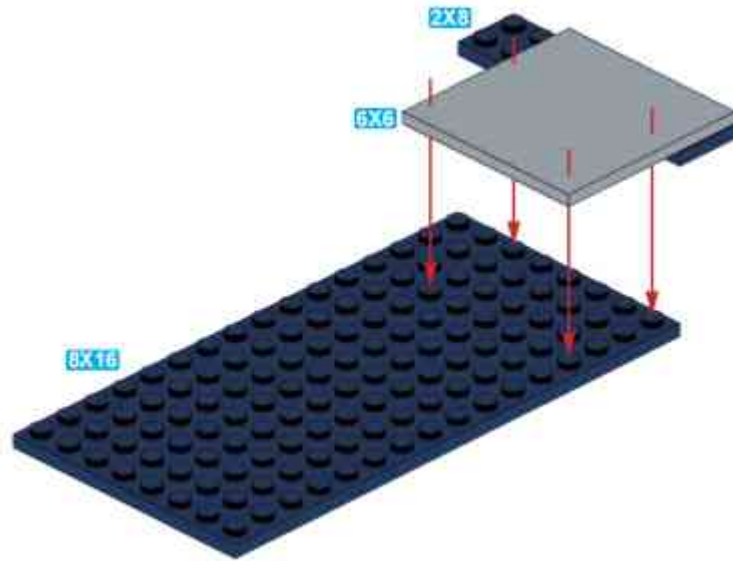

## J76

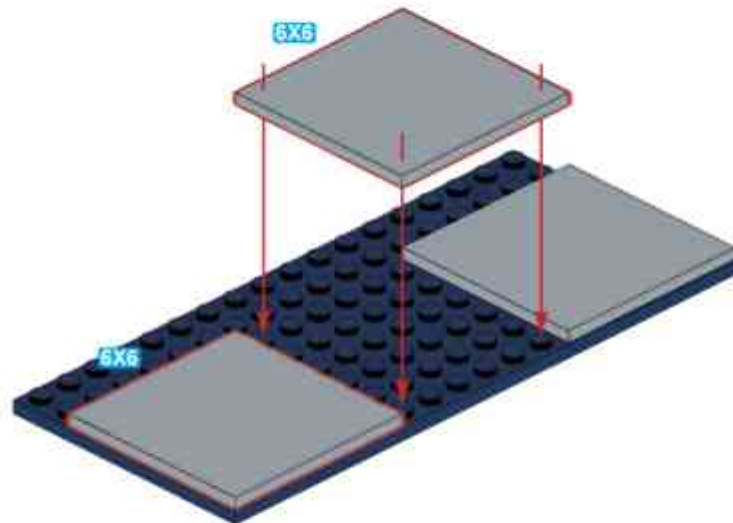



## J77

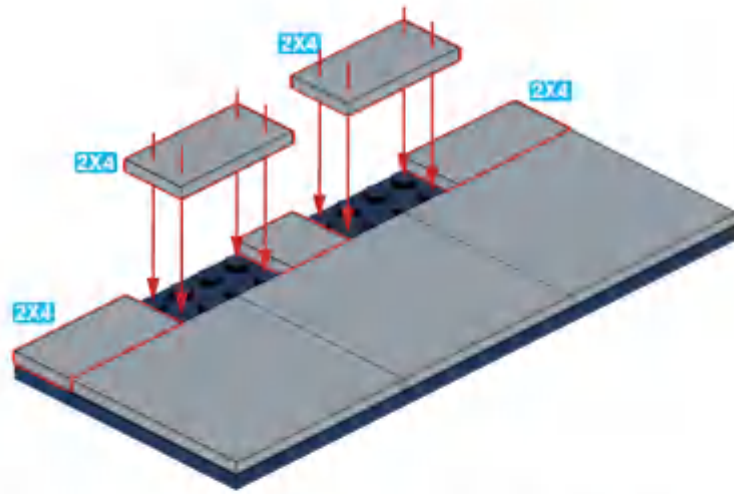

## J78

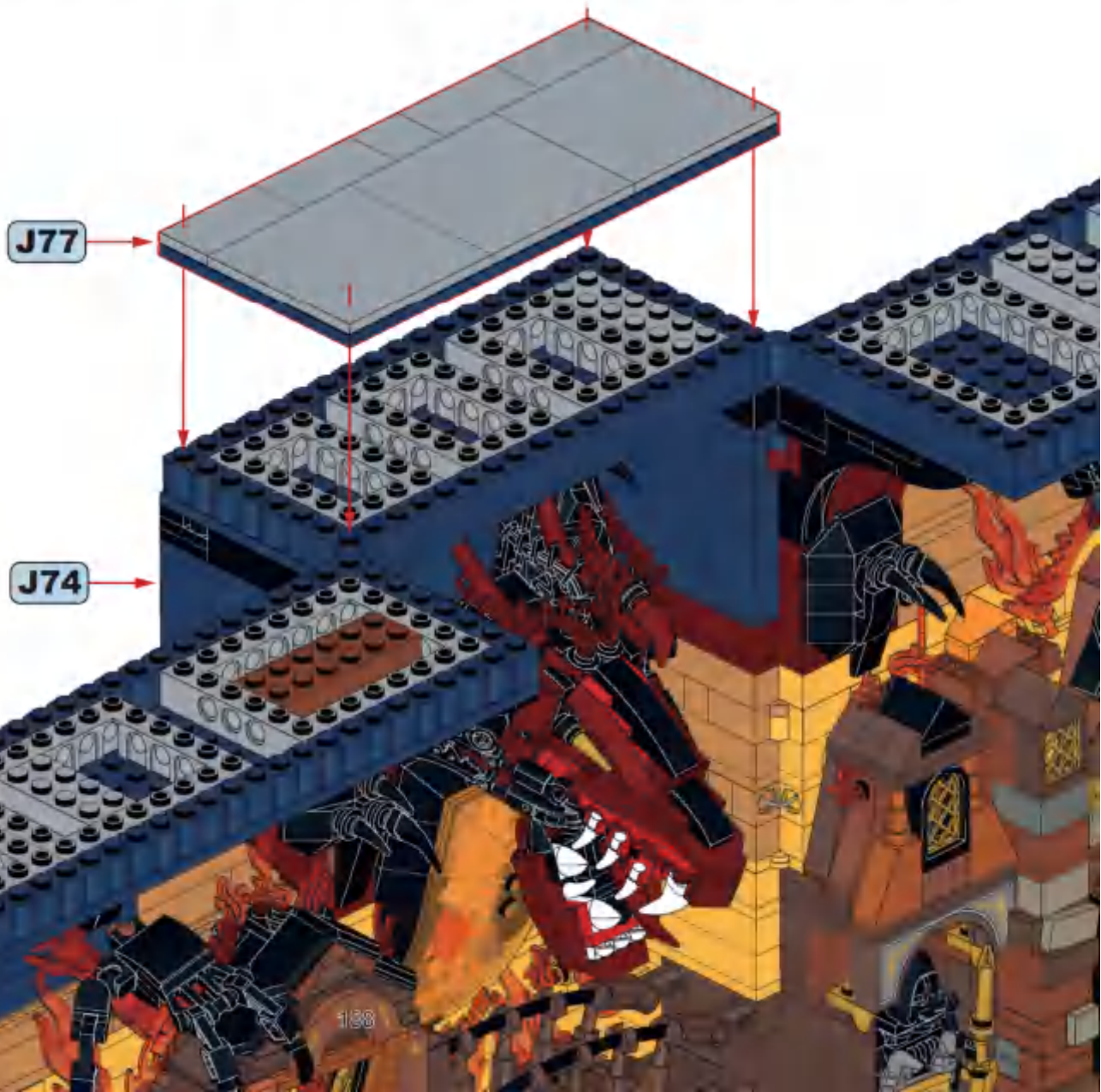

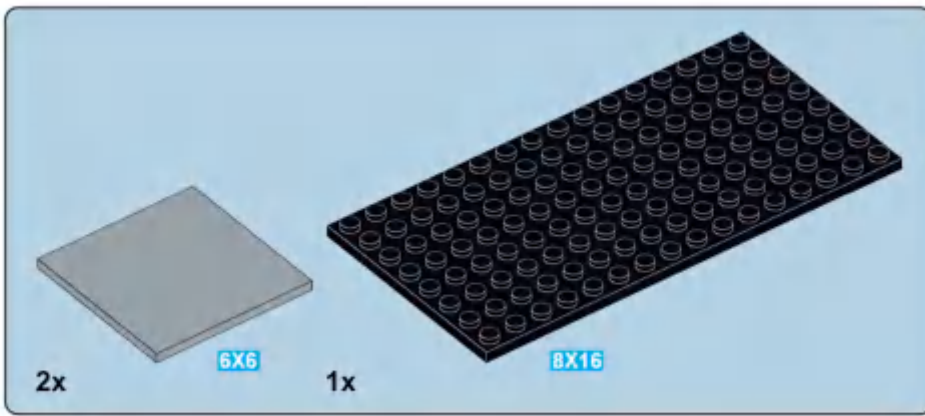

## J79

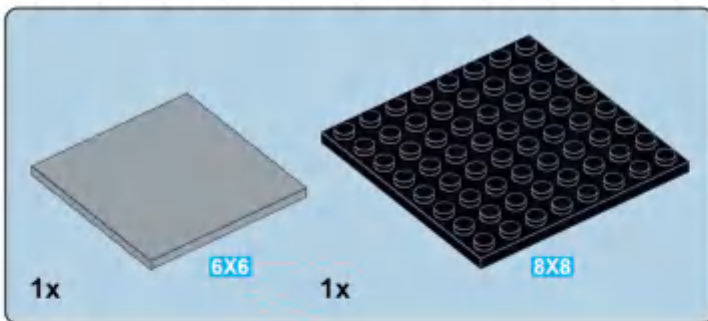
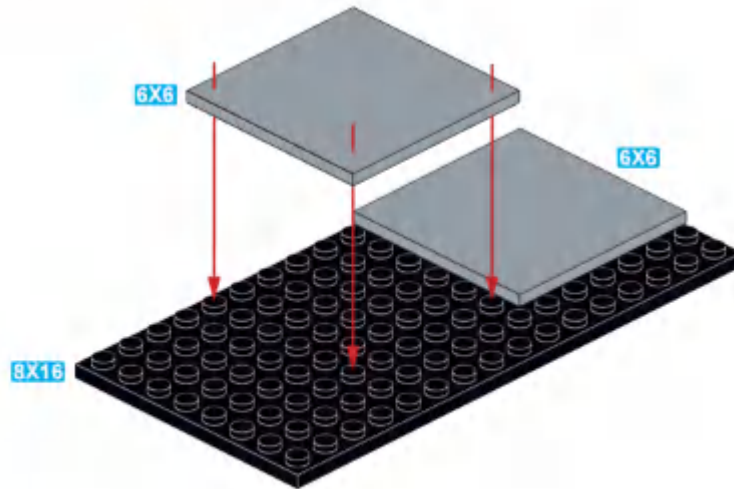

## J80

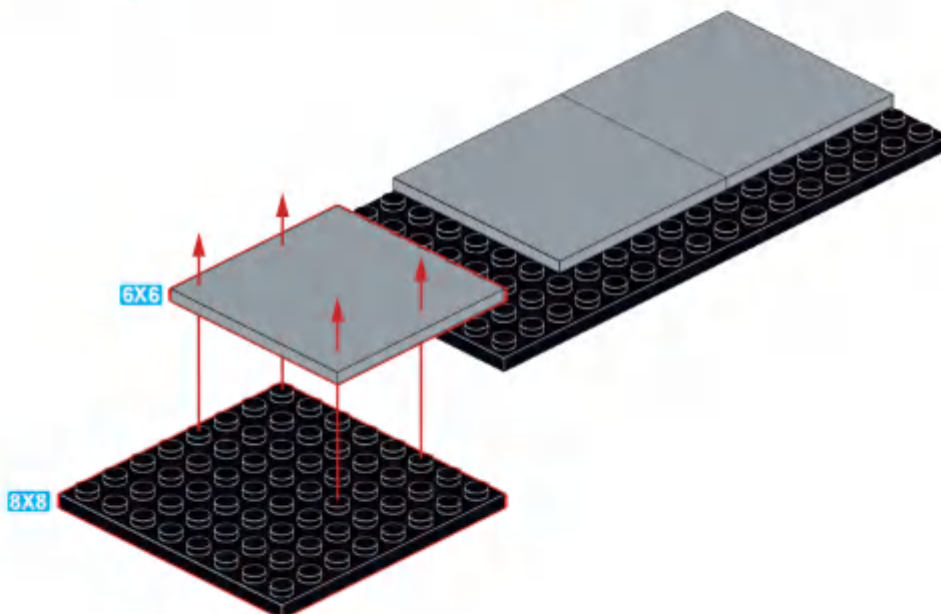

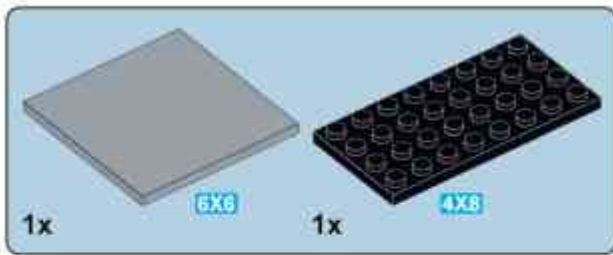

## J81

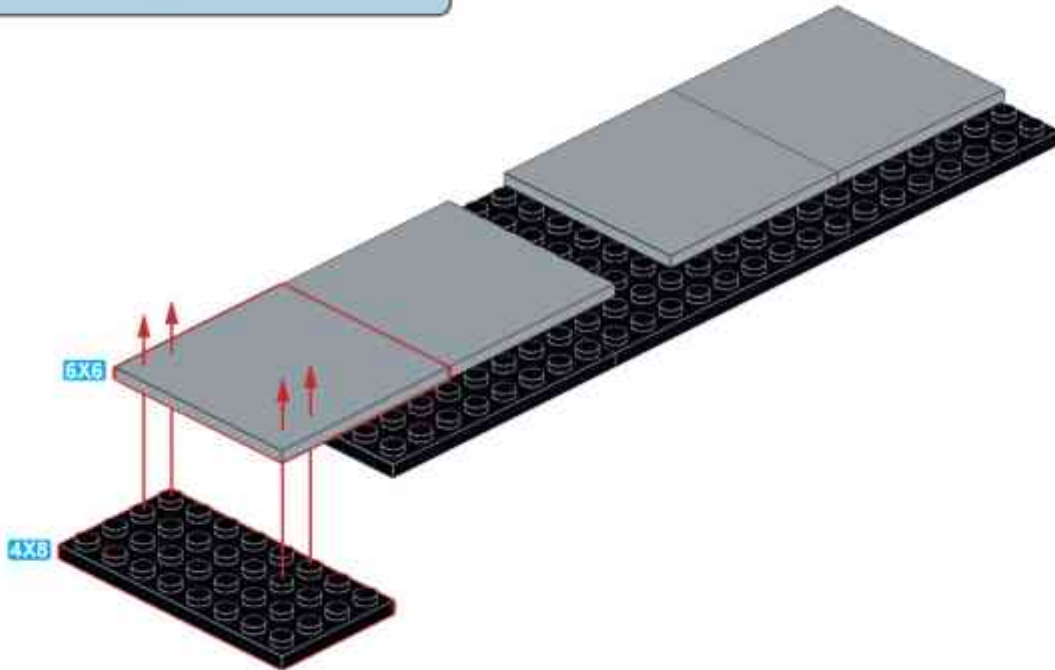

## J82

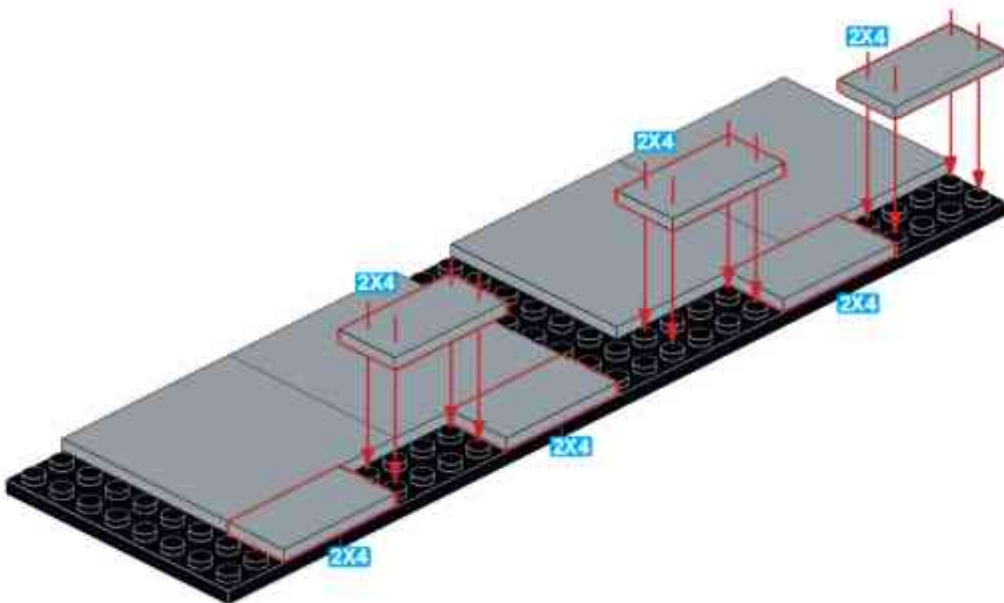



**J83**

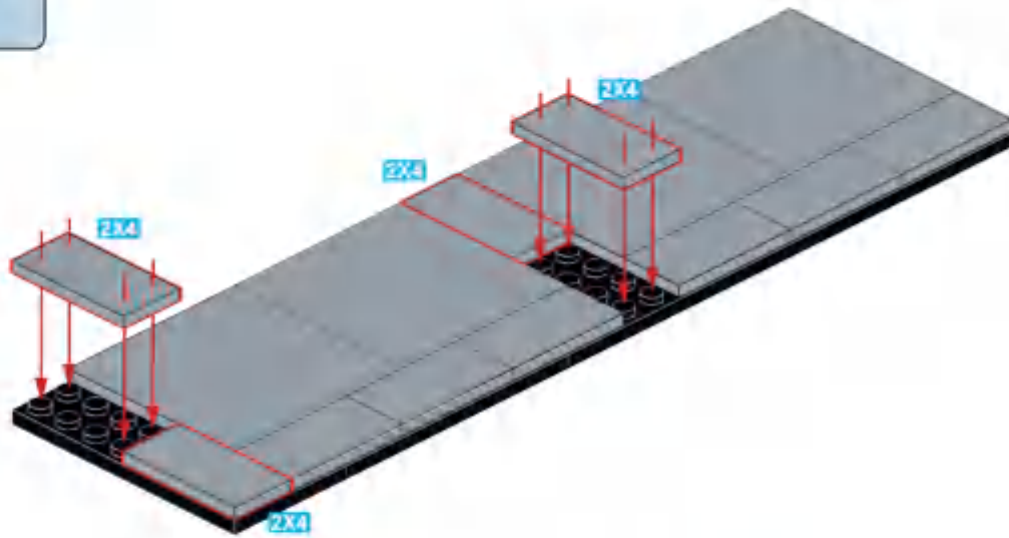

**J84**

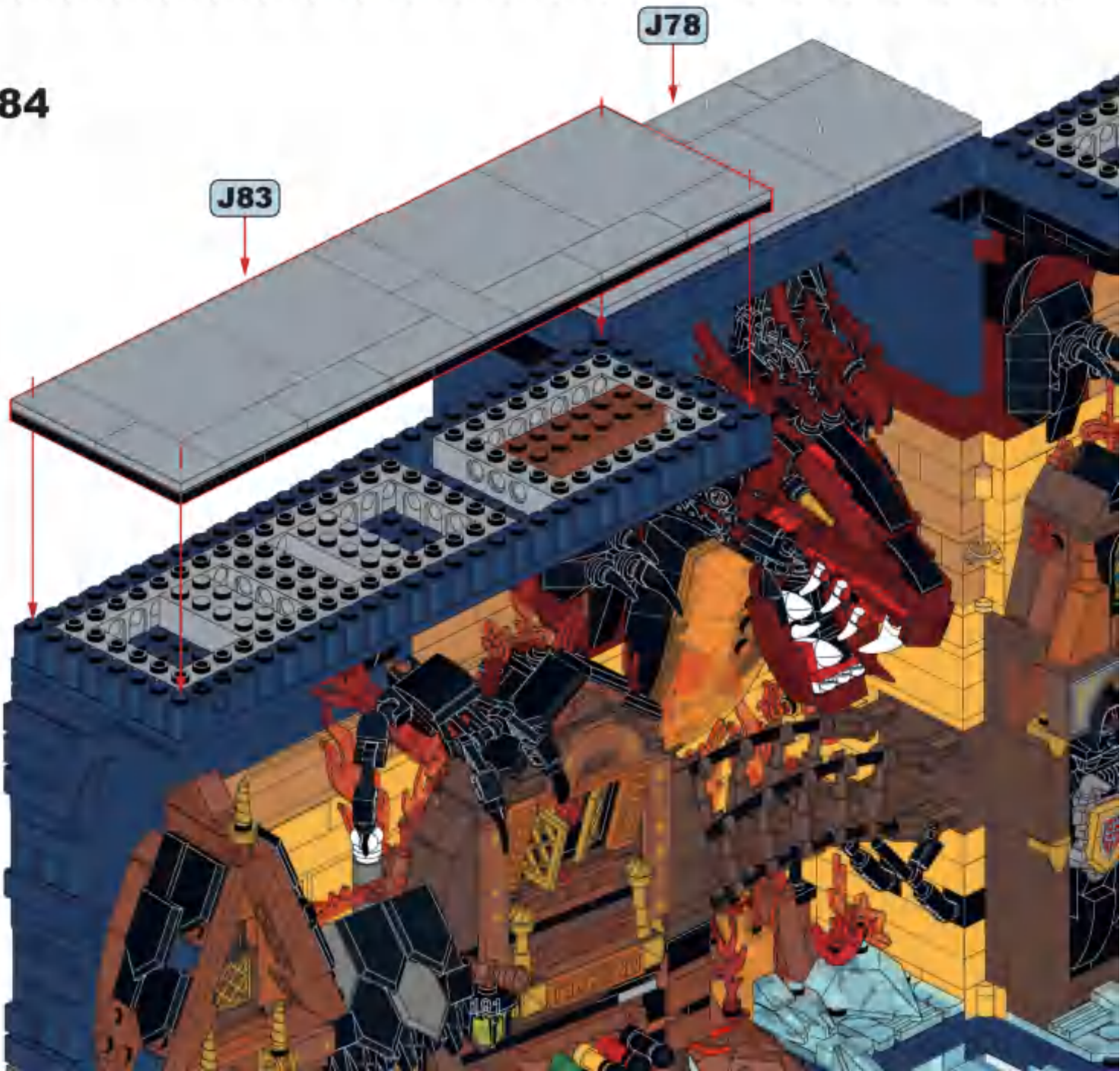

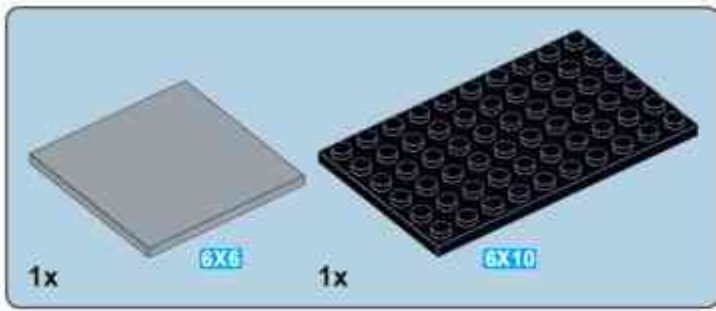

### J85

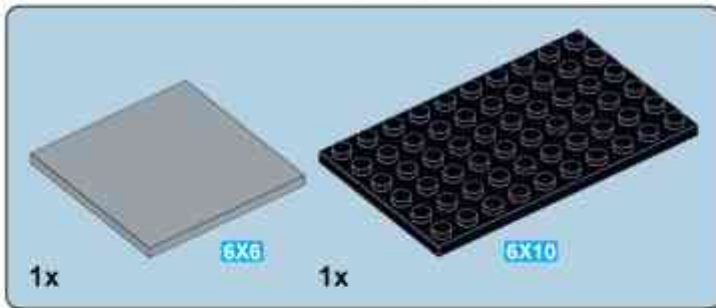
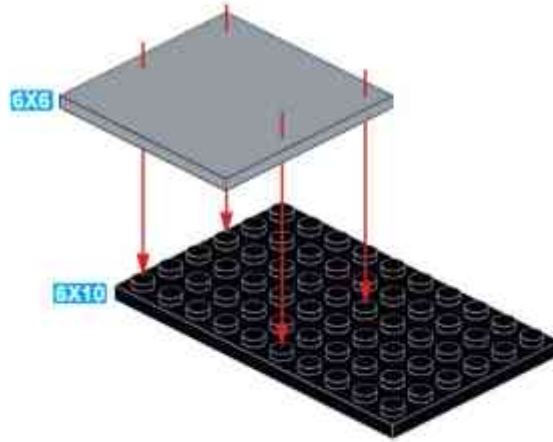

### J86

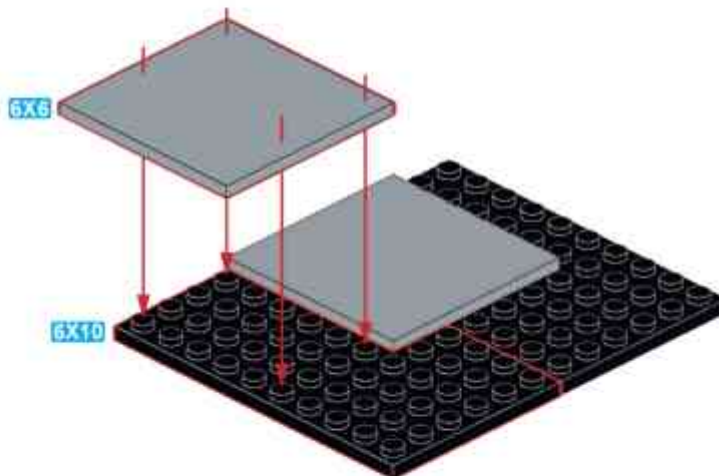

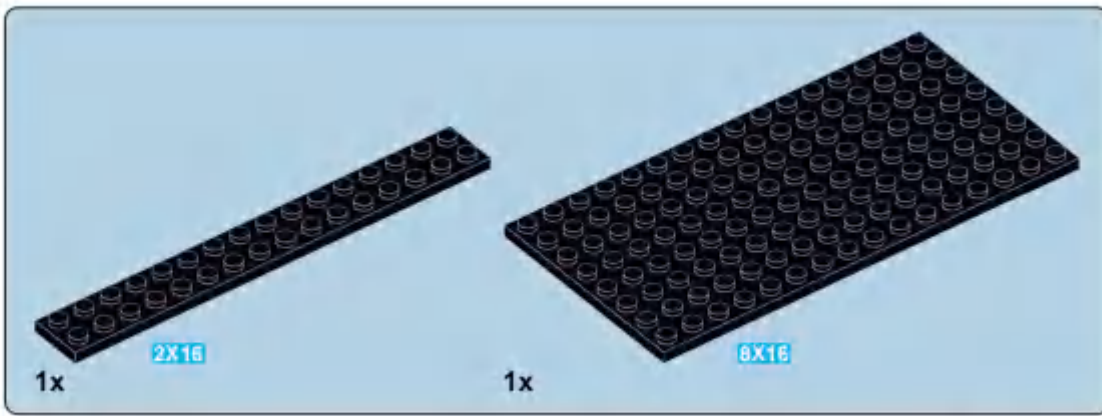

## J87

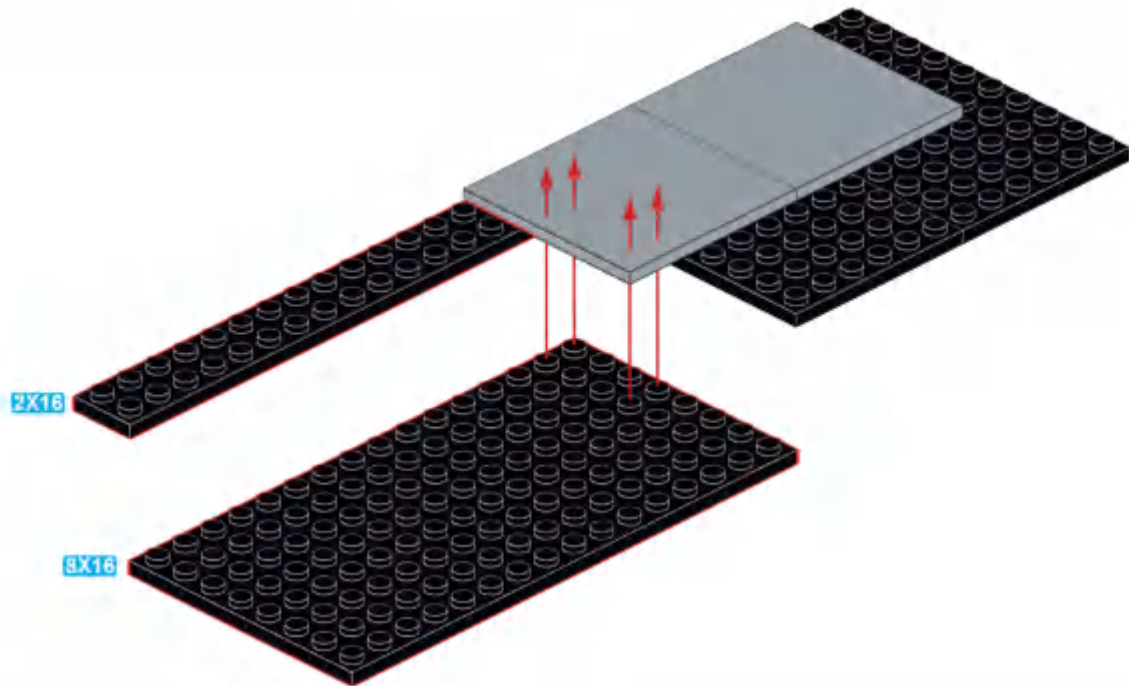

## J88

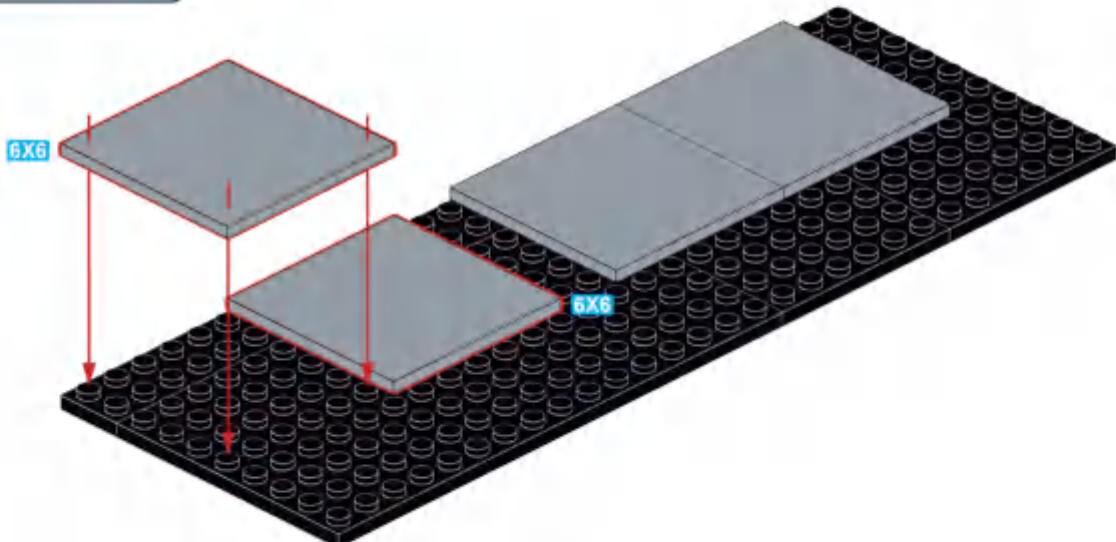

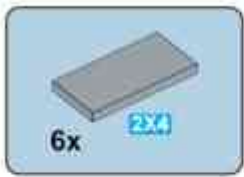

## J89

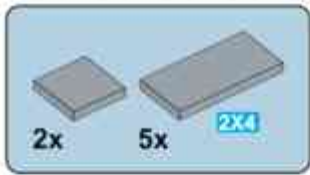
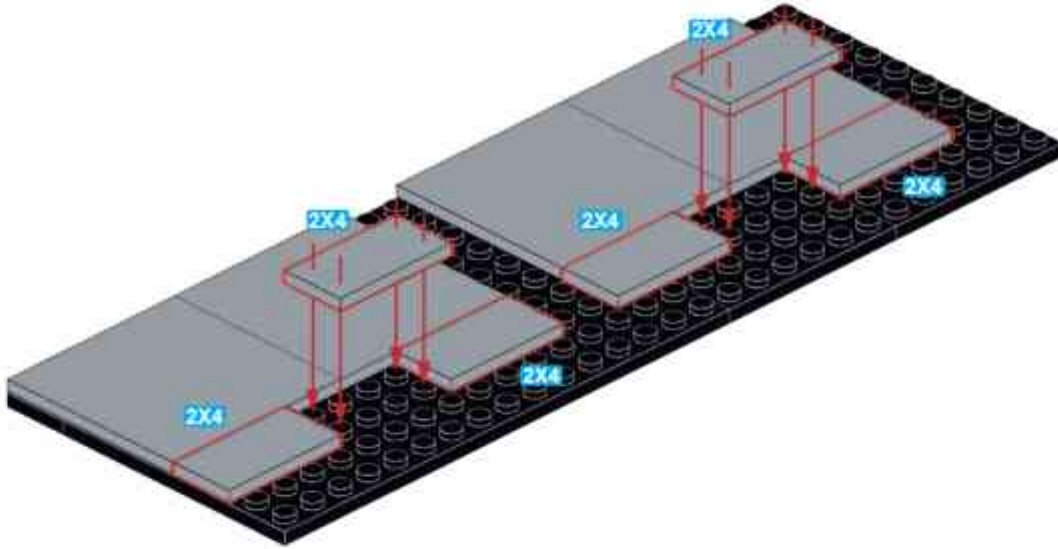

## J90

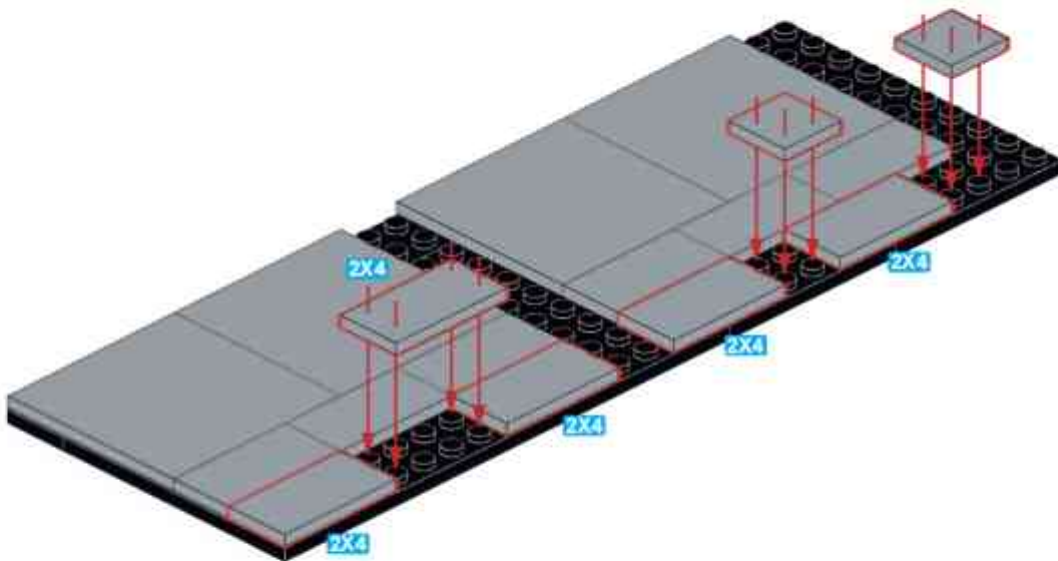



# J91

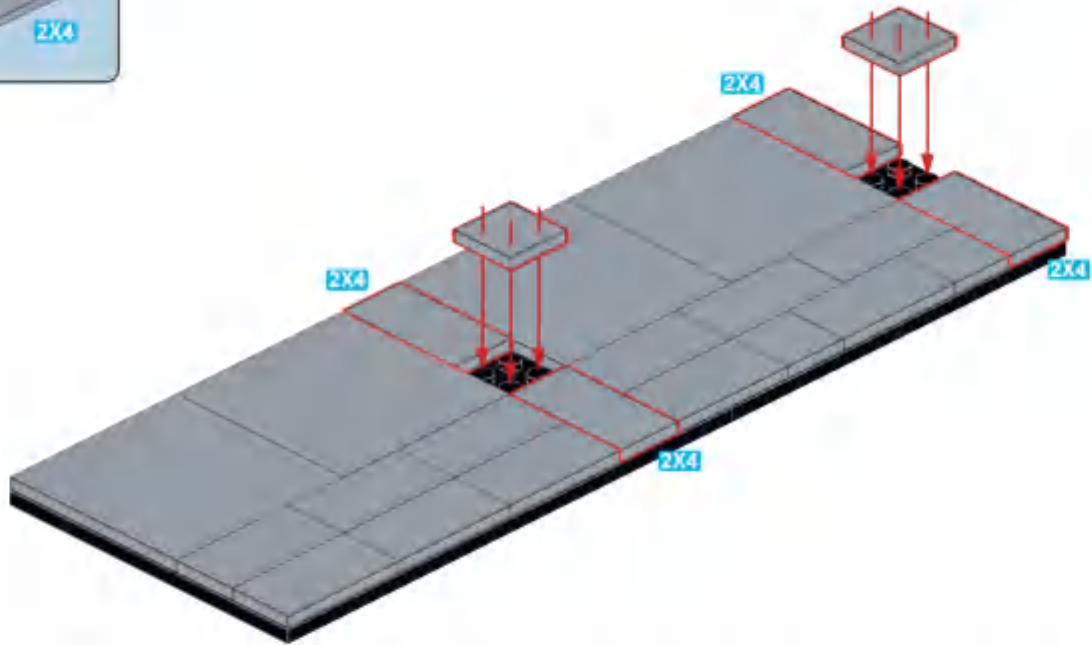

# J92

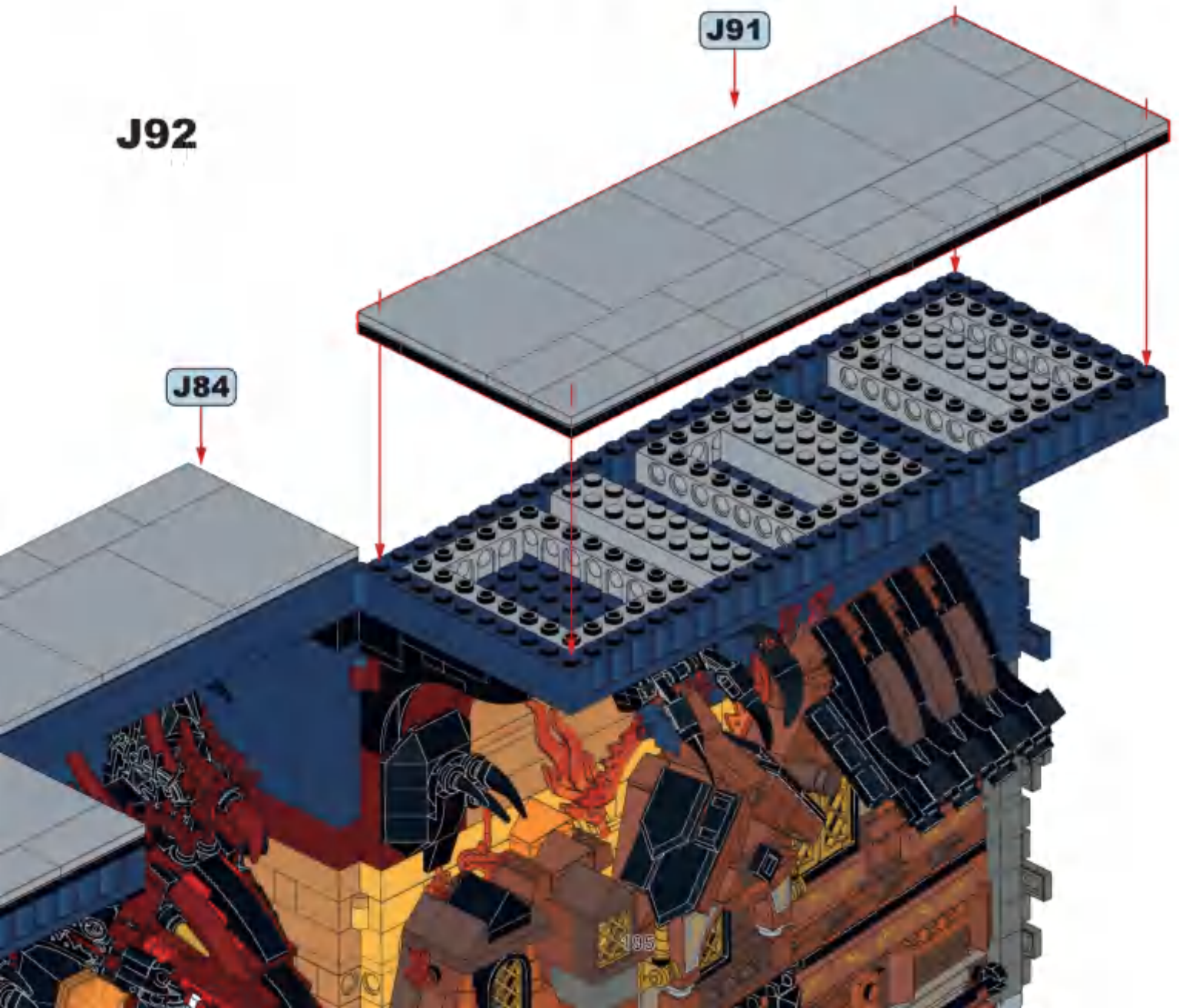



J93

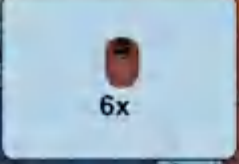
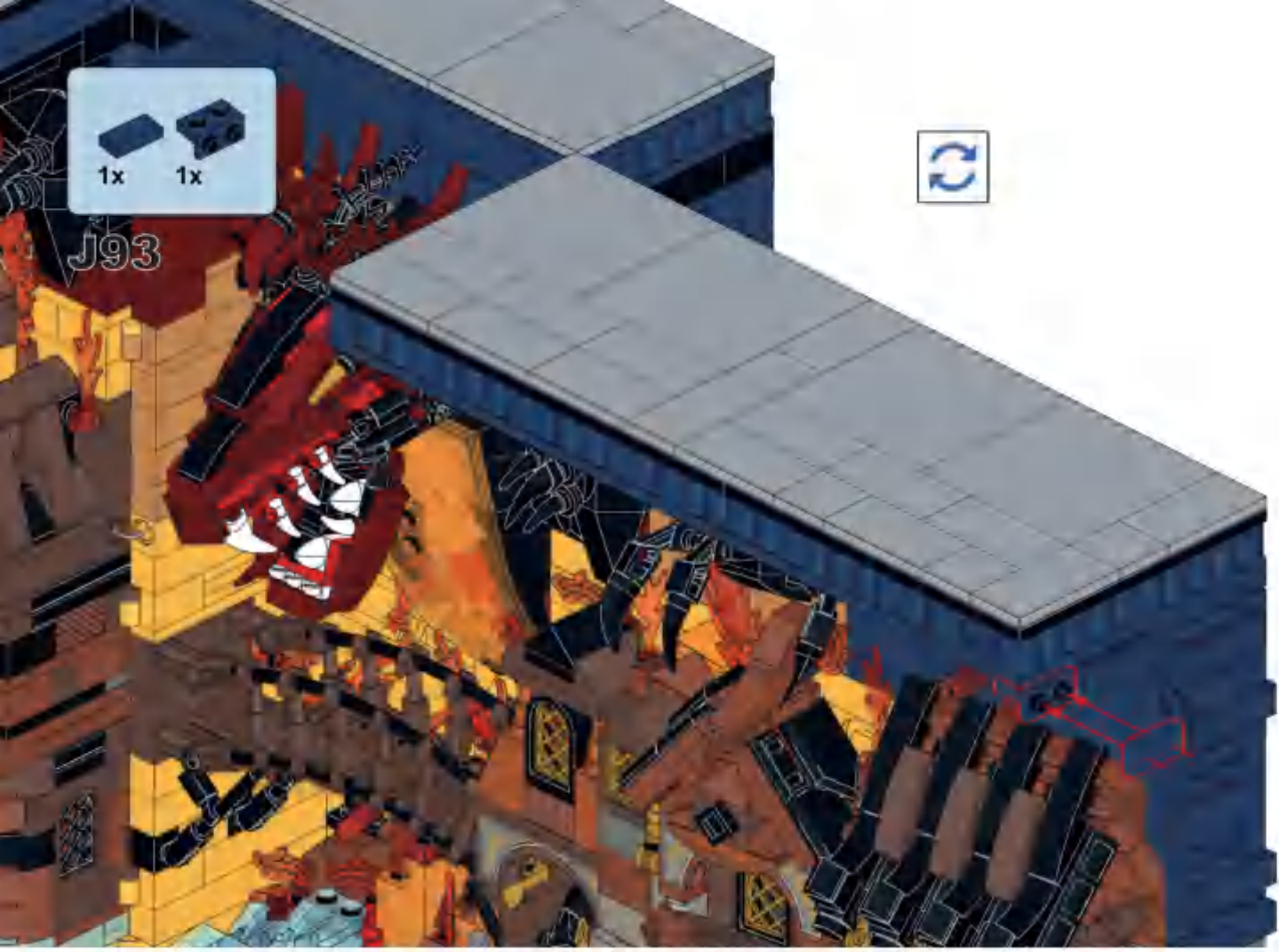

J94



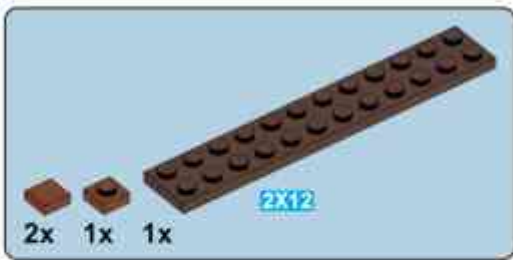

**J95**

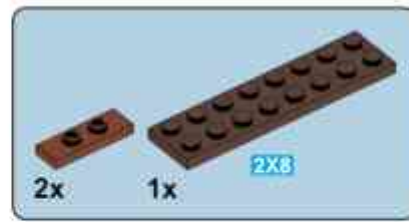
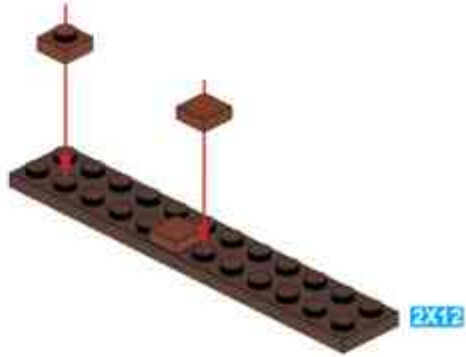

**J96**

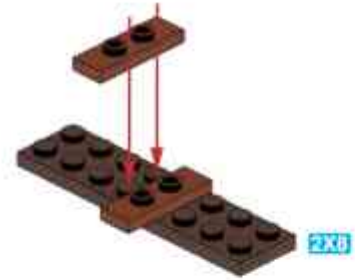

**J97**

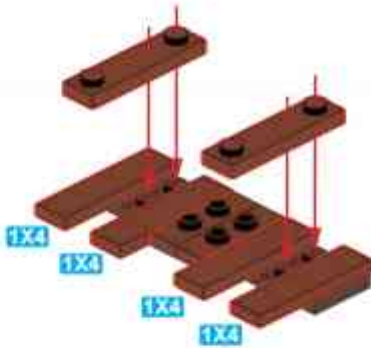

**J98**

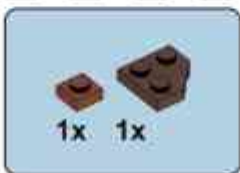
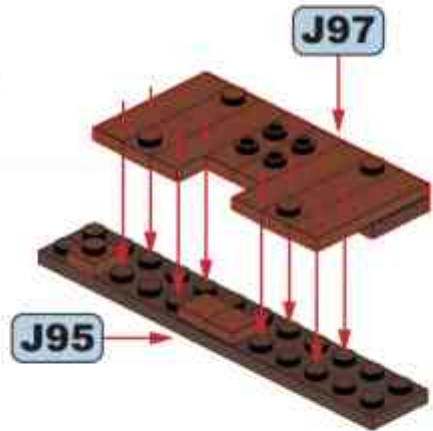

**J99**

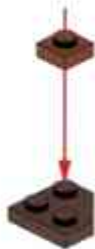

**J100**

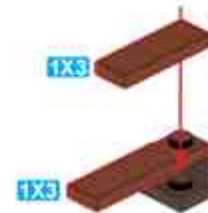

# J101

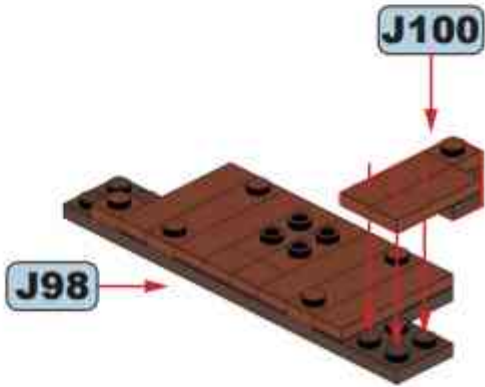

# J102



# J103

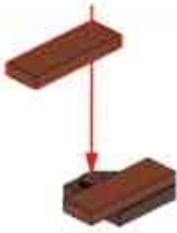

# J104

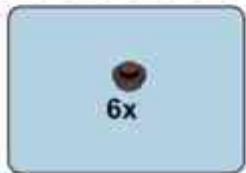
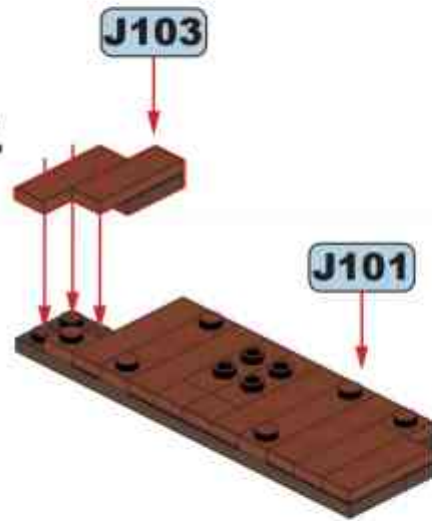

# J105

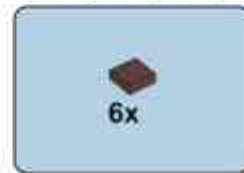
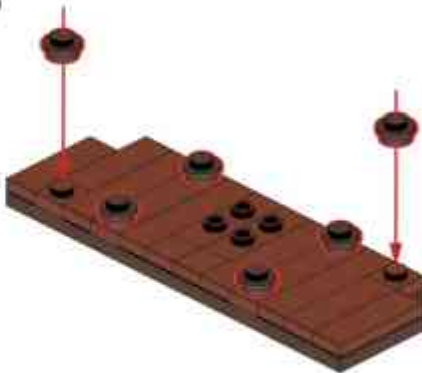

# J106



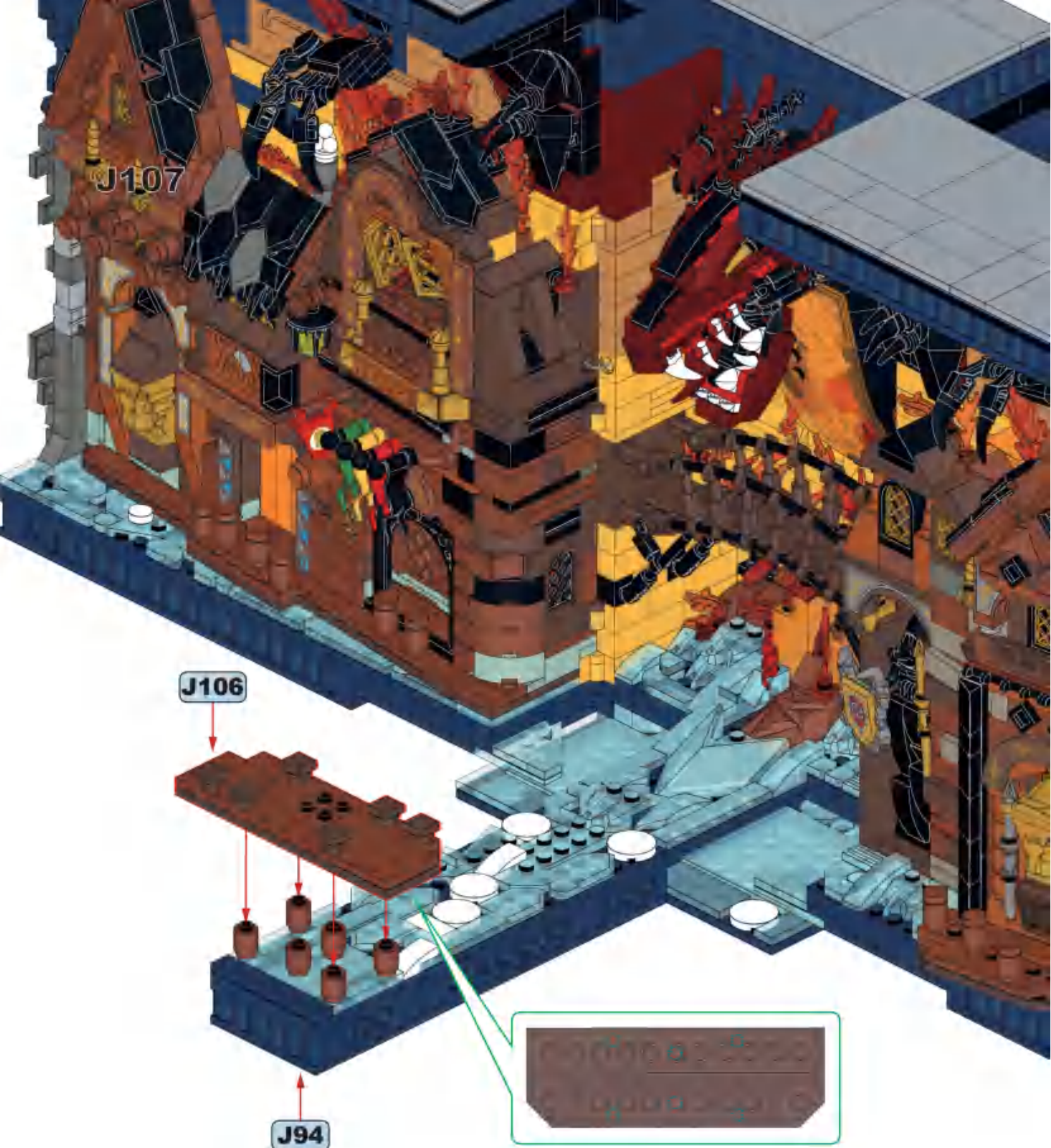



J108



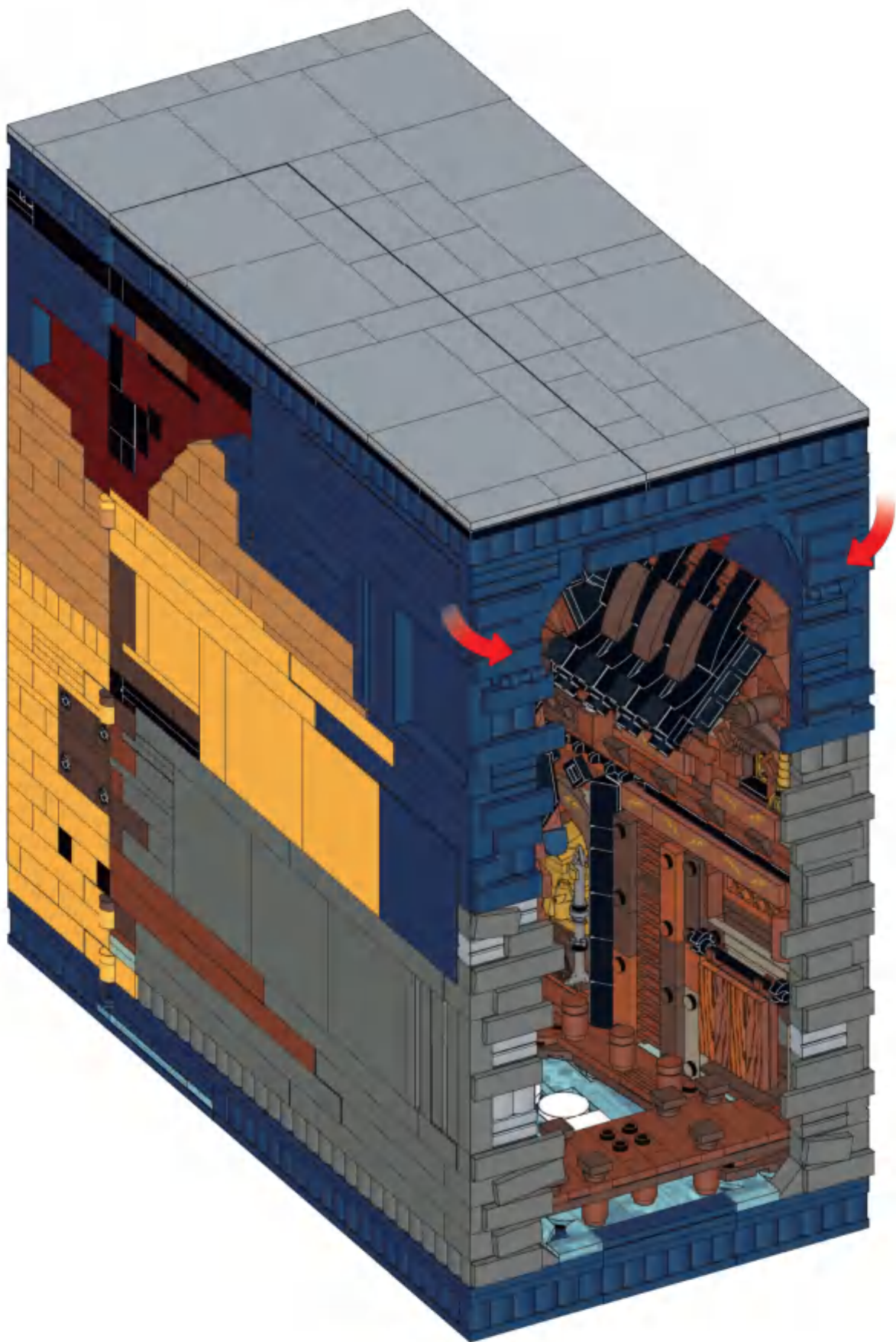

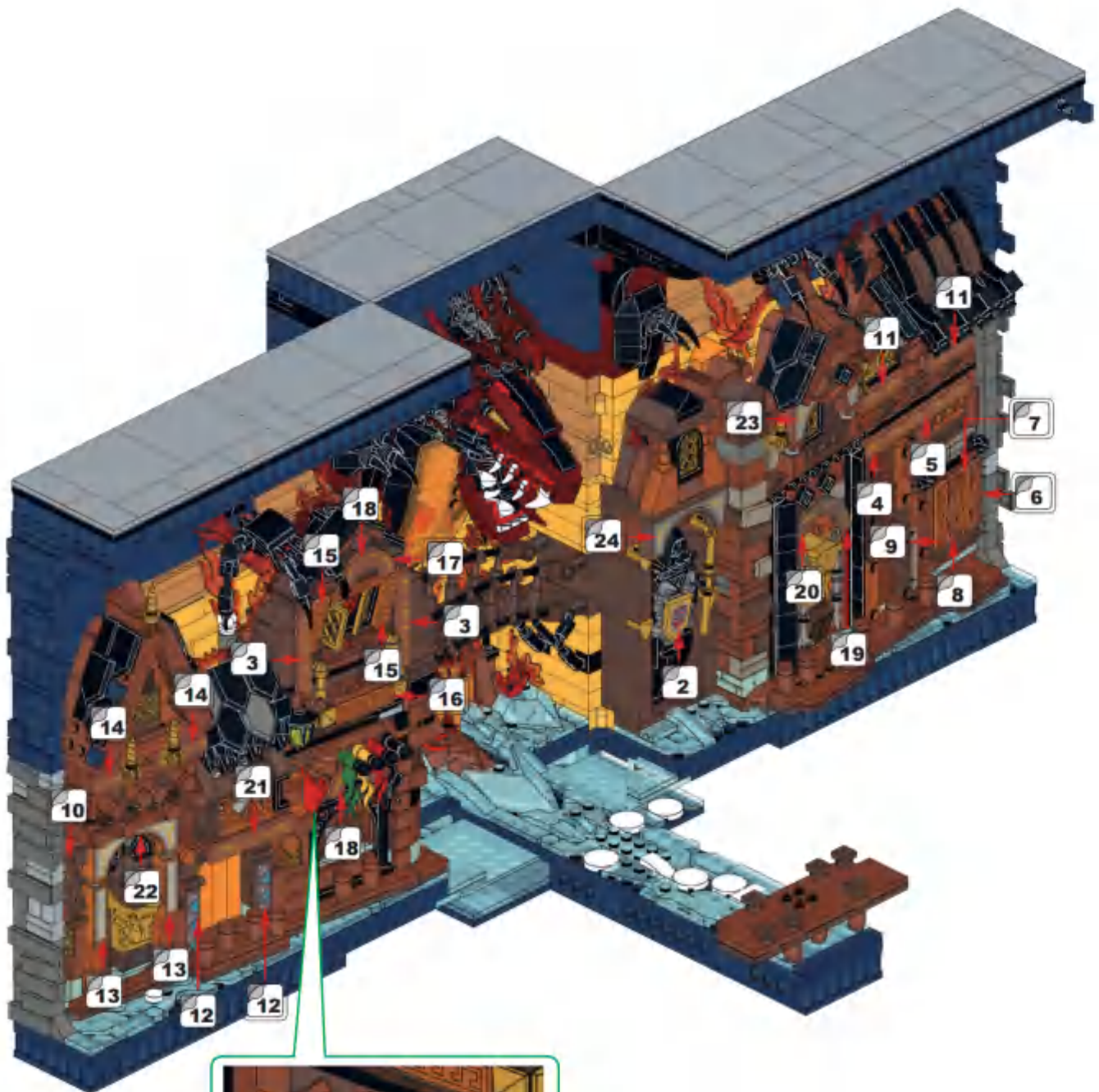



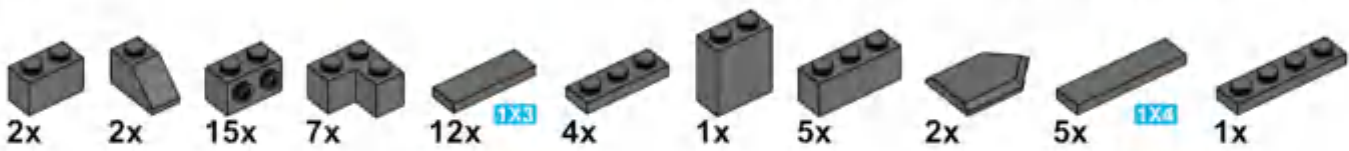
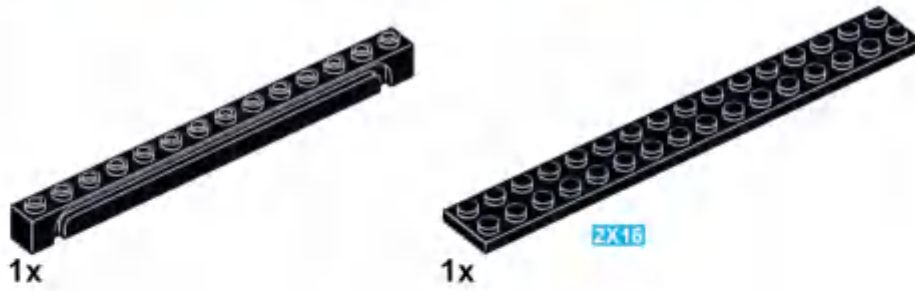
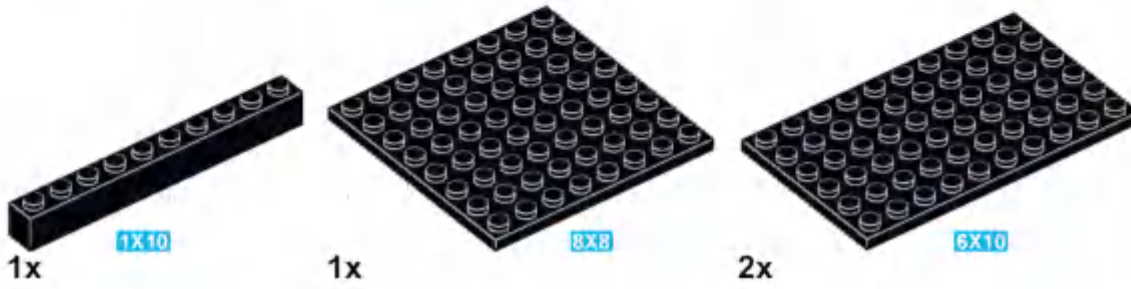
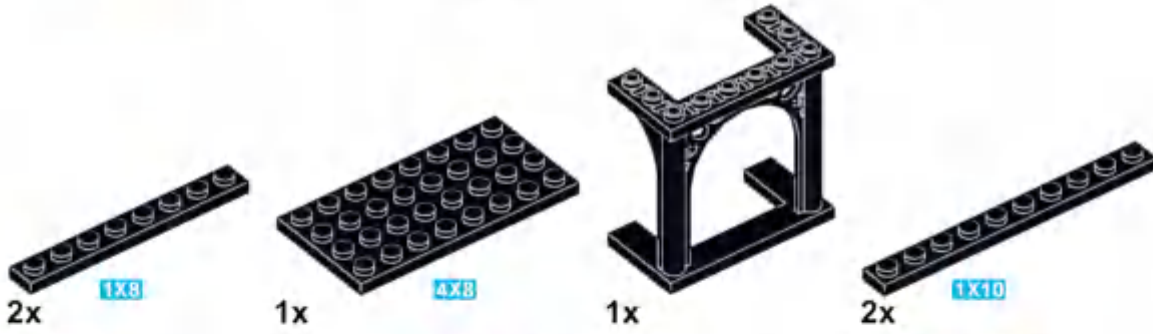

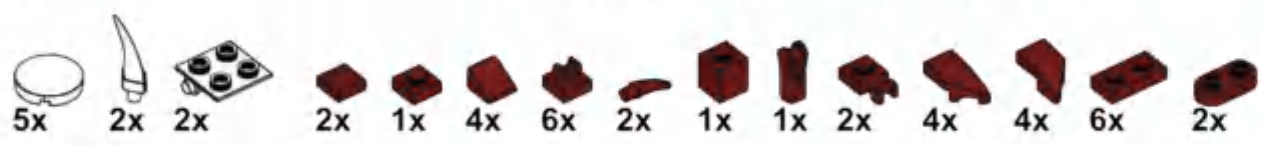
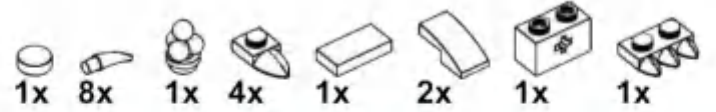
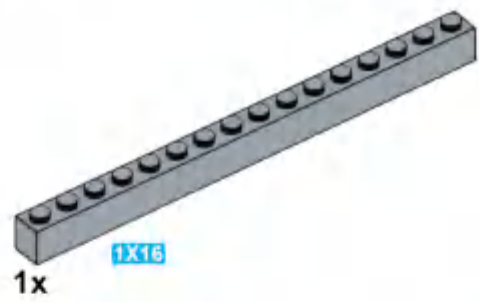
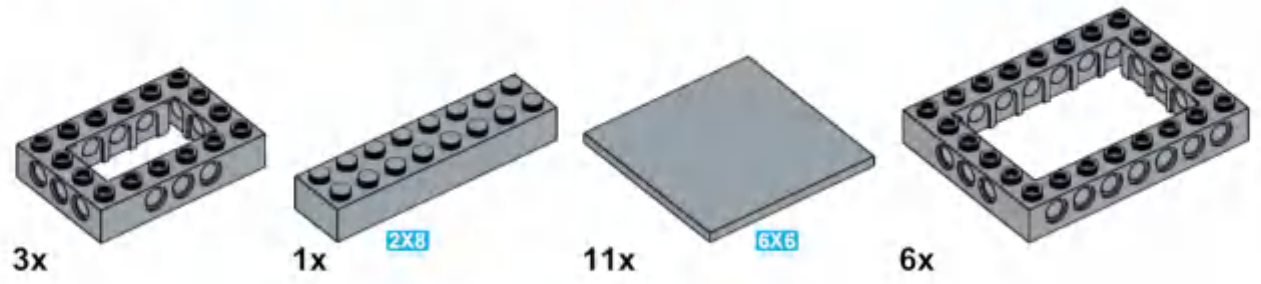
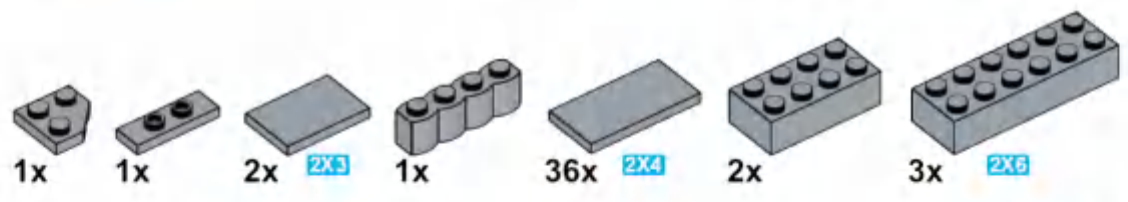
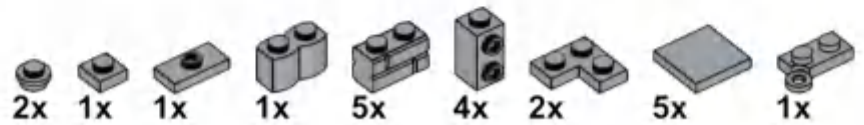
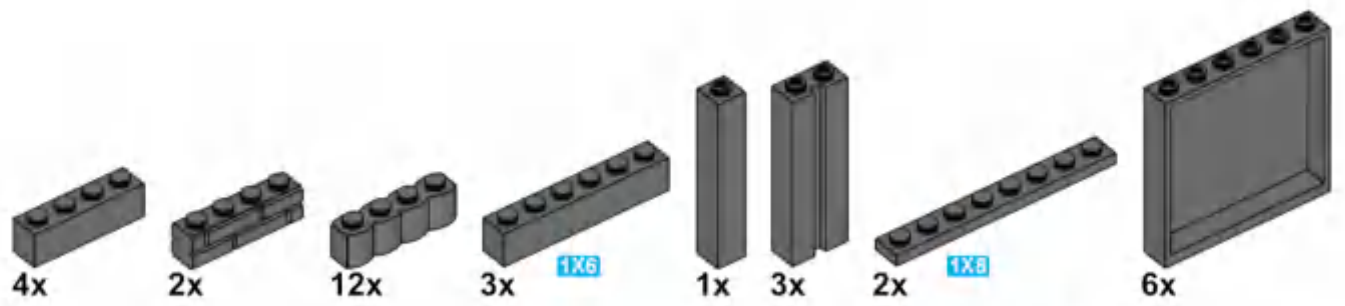

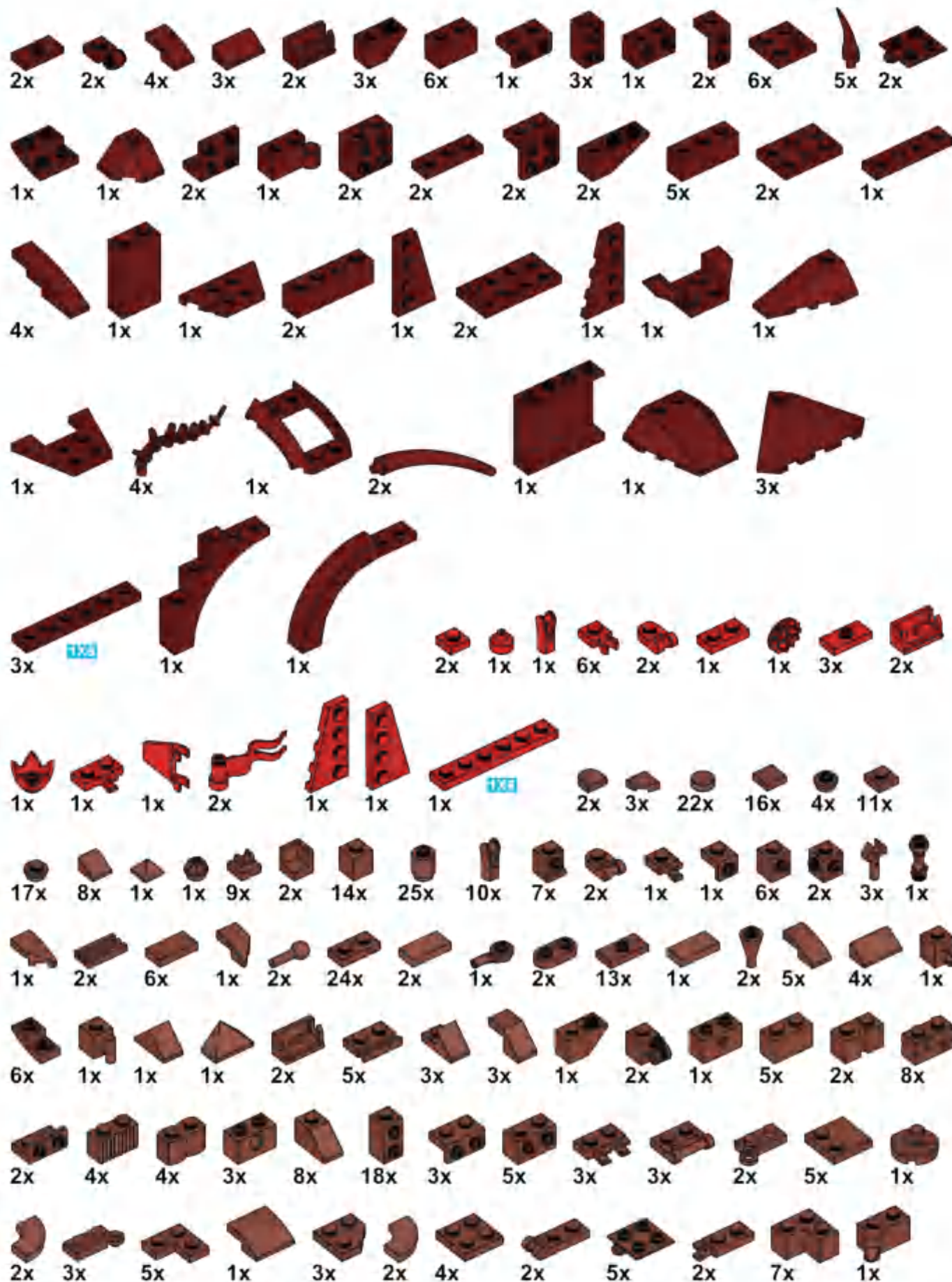

1x 7x 1x 4x 1x 2x 2x 1x 11x 1x 7x **1x3**

3x 9x 4x 7x 1x 2x 4x 7x 1x 1x 2x

3x **1x** 4x 4x 8x 13x **1x4** 2x 7x 1x 1x

1x 2x 4x 2x 4x 2x 4x 3x 2x

1x 1x 1x **2x4** 2x 1x 1x 1x

5x **1x6** 9x **1x6** 5x **1x6** 1x 1x

1x 3x **2x6** 2x **2x6** 1x 1x

4x **1x8** 9x **1x8** 3x **1x8** 2x **2x8**

1x **5x6** 2x **1x10** 1x **2x10** 1x **1x12**

